	Document name	PV Module Installation Instructions		
	Document number	HTL-TR-I062 (V2.4)		
Shanghai Aerospace Automobile Electromechanical Co., Ltd.	Document version	V2.4	Page	1 / 28

PV Module Installation Instructions



Shanghai Aerospace Automobile Electromechanical Co., Ltd.

	Document name	PV Module Installation Instructions		
	Document number	HTL-TR-I062 (V2.4)		
Shanghai Aerospace Automobile Electromechanical Co., Ltd.	Document version	V2.4	Page	2 / 28

Contents

1. Basic Information.....	3
1.1 Preface Introduction.....	3
1.2 Warnings.....	3
1.3 Product Identification.....	5
2 System Design.....	6
2.1 Climatic Conditions	6
2.2 Location Selection.....	6
2.3 Installation Inclination Angle Selection	7
2.4 Choose the Photovoltaic Support	8
2.5 Choosing the Photovoltaic Inverter.....	8
2.6 Bifacial Module Arrangement and Layout Optimization.....	9
3 Installation.....	10
3.1 Installation Safety.....	10
3.2 Modules Unpacking	11
3.3 Introduction of Installation Method	13
3.4 Installation of Clamps	14
3.5 Installation of Bolts	19
3.6 Installation of Single-axis Tracking System.....	21
4 Electrical Connection	22
4.1 Precautions for Electrical Connection.....	22
4.2 Wiring and Connections	24
4.3 Structure of PV station	26
5 Maintenance	26
6 Disclaimer	27

	Document name	PV Module Installation Instructions		
	Document number	HTL-TR-I062 (V2.4)		
Shanghai Aerospace Automobile Electromechanical Co., Ltd.	Document version	V2.4	Page	3 / 28

1. Basic Information

1.1 Preface Introduction

Thanks for choosing PV modules of Shanghai Aerospace Automobile Electromechanical Co., Ltd.. The PV modules in this manual were manufactured or sold by our company.

This manual contains the information of installation and safe operation of HT-SAAE's PV modules (hereafter referred to as "module").

All instructions should be read carefully before installation. Please contact our sales department for more information if you have any question.

The installer should be familiar with the mechanical and electrical requirement of PV system. The installer should comply with safety precautions listed in this manual and local law regulations when installing the modules.

According to IEC61730 standard, the safety class of solar module is class II; the fire protection grade of solar module is class C (refer to UL790).

1.2 Warnings

1.2.1 It requires specialized skills and knowledge for installation of solar photovoltaic systems. It should be operated by professional installation personnel who have qualified licensed.

1.2.2 When the modules are exposed to sunlight or other light sources, DC current is generated in the modules. At this time, if touching the electrical part of the modules, it may happen electric shock hazard.

1.2.3 The modules could be installed in outside environment, such as ground, roofs etc. If the modules are installed on the roof, the roof should have a certain fire protection capability. It can consult the local construction department to decide the roof material. Do not use this module to replace the whole or partial roofs/walls of living buildings. The system designer or installer have responsible for reasonable support structure.

1.2.4 Do not disconnect any of the modules connector during work.

1.2.5 Do not disassemble modules or move nameplate or any adhesion parts of modules.

	Document name	PV Module Installation Instructions		
	Document number	HTL-TR-I062 (V2.4)		
Shanghai Aerospace Automobile Electromechanical Co., Ltd.	Document version	V2.4	Page	4 / 28

1.2.6 Do not place the modules near a supply/storage of combustible gases.

1.2.7 Do not use Artificially concentrated sunlight on the module. Do not expose the back of the module to sunlight for a long time.

1.2.8 Avoid dropping or covering on the modules. Do not tread, stand or walk on modules, because there is a risk of damage to the module and harm to person.



1.2.9 Avoid moving the modules by pulling cables or the junction box.

1.2.10 Keep children away from modules during transportation and installation.

1.2.11 Avoid wearing metal rings, bracelet, earrings, nose rings, lip rings or any metal accessories during transportation and installation of the modules. Do not touch electrical part of the modules by hand without any insulated protection. Use insulated tools which satisfy electrical requirement to connect electrical parts of the modules.

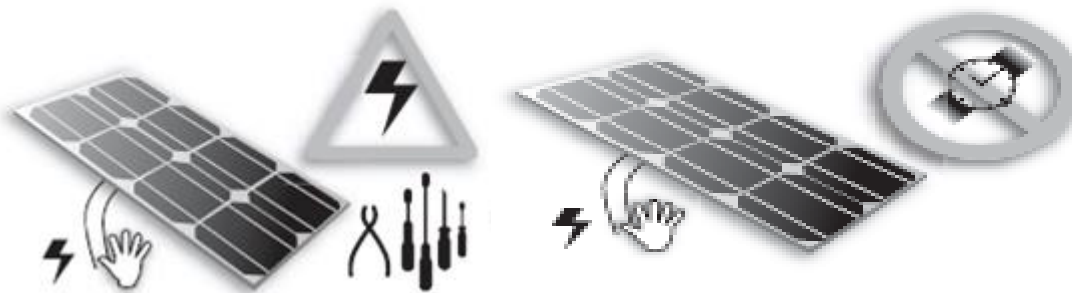

1.2.12 During transportation of the modules, please make sure that any impact and strenuous vibration should be avoid. The impact and strenuous vibration have possible to lead cracks of solar cell in the modules. When the modules arrive the destination, before installation, the module should be placed on the flat ground with protection which has ability to avoid moisture, wind, rain and snow. Please unpack carefully.

1.2.13 Avoid any damage of the glass of the module, which can protect the modules. Avoid any

	Document name	PV Module Installation Instructions		
	Document number	HTL-TR-I062 (V2.4)		
Shanghai Aerospace Automobile Electromechanical Co., Ltd.	Document version	V2.4	Page	5 / 28

damage of the seal on the edge of the modules. Without seal protection, the modules have risk of destroy. The damage modules have risk of electric shock or fire. The damage module can't be repaired. If there is any damage on the modules, please replace the modules immediately.

1.2.14 In order to reduce the risk of electric shock or combustion, opaque material can be used to cover the front surface of the modules during installation.

1.2.15 Installers should make sure firm connections between the rack and PV module without loose connections.

1.2.16 The frame and support of all modules should be grounded correctly, according to “National Electrical Code”.

1.2.17 Do not clean the modules with corrosive chemicals.

1.2.18 It is possible to affect fire resistance of the house if roof-mounted. According to IEC61730, the level of fire resistance of modules, which is installed on roof, is Class C (refer to UL790). For roof application, the estimate of fire control level of module system should combine module and roof condition. Only correct installation, which accords to installation instruction, the fire resistance of module system is effective.

1.2.19 During the storage, transportation, installation and maintenance of components, it is strictly prohibited to contact with any form of oil stain or corrosive chemical reagent.

1.3 Product Identification

1.3.1 Each module has a label on the back, generally containing following information: product type, weight, size, fuse current, the system max voltage, rated power measured under standard test conditions, rated current, rated voltage, open circuit voltage, short circuit current.

1.3.2 Bar code (serial number): each module is registered with a unique serial number. It is fixed in the module permanently. It can see the bar code in front of the module.



Figure1 Bar Code

	Document name	PV Module Installation Instructions		
	Document number	HTL-TR-I062 (V2.4)		
Shanghai Aerospace Automobile Electromechanical Co., Ltd.	Document version	V2.4	Page	6 / 28

1.3.2.1 The barcodes of the conventional modules consist of 14 characters and underlines with unique module numbers, whose definition is as below: the first 8 characters are made up of factory code with 2 characters, date code with 3 characters and order serial number with 3 characters and followed by a dash. The 6 characters after dash are module production serial numbers. The module number of one work order cannot exceed 999,999 pieces.

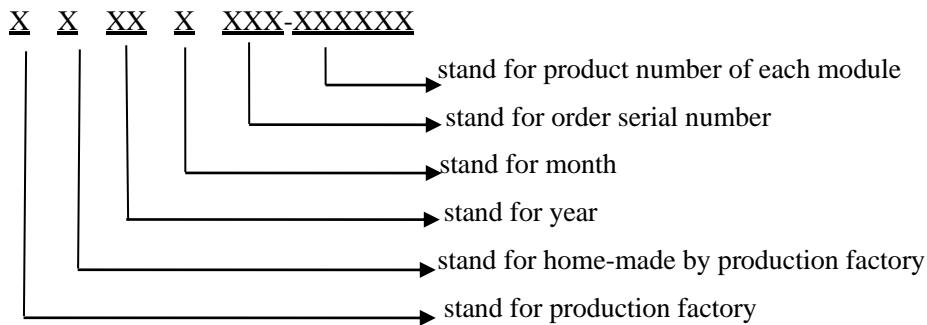

2 System Design

2.1 Climatic Conditions

2.1.1 Relative humidity: < 85%.

2.1.2 The operating temperature of the module is - 40 °C - 85 °C.

Note: When calculating the mechanical load of components (including the pressure of wind and snow), the installation method and installation site should be considered. The calculation of mechanical load must be carried out by professional personnel according to the design requirements of the system.

2.2 Location Selection

2.2.1 The maximum altitude for HT PV module is 2000m.

2.2.2 At standard test conditions (1000W / m² irradiance, AM 1.5 spectrum, 25 °C (77 °F) ambient temperature), the test error of module electrical performance parameters of modules, such as I_{sc}, V_{oc}, and P_{max}, is ±3% for P_{max} and ±5% for V_{oc} and I_{sc}.

2.2.3 In the northern hemisphere, it advises that the modules face to south direction. In the southern hemisphere, it advises that modules face to north direction.

	Document name	PV Module Installation Instructions		
	Document number	HTL-TR-I062 (V2.4)		
Shanghai Aerospace Automobile Electromechanical Co., Ltd.	Document version	V2.4	Page	7 / 28

2.2.4 The tilt angle of the PV module is the angle between the surface of the PV module and a horizontal ground surface (as shows in Figure 2). The PV module generates maximum output power when it faces the sun vertically. It is recommended that the installation angle of the module is bigger than 10 degrees. If you want the specific information of the best install tilt angle, please consult reliable local photovoltaic system installation companies.

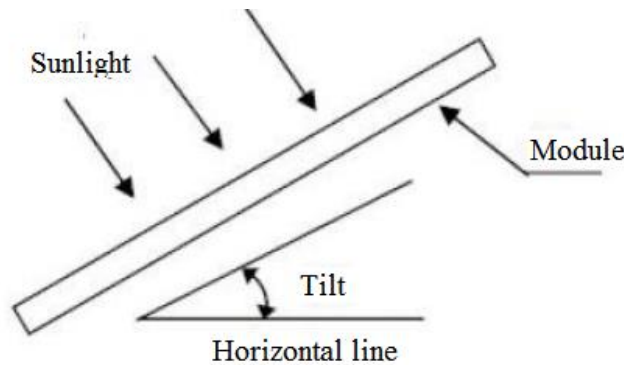

Figure 2 PV module tilt angle

2.2.5 The modules should be installed in the position where is full of sun exposure without shadow at any time.

2.2.6 Generally, it is not recommended to be installed in the place where is less than 500 meters from the sea. The modules, as a general rule, can guarantee 25 years of useful life if the module is installed in the place where is more than 3 km from the sea. If the module is installed in the place where is 500-3000m to the sea, the modules need extra protection. (For example, increasing the thickness of the oxide film of Aluminum metal alloy frame, and increasing the anti-corrosion treatment of frame connection.)

2.2.7 When a storage battery is used in the photovoltaic system, the battery must be installed correctly. Therefore, it can protect the safety of photovoltaic system. The installation of the storage battery should follow the instructions of storage battery manufacturer.

2.2.8 It is recommended that the height of the module is 0.3-1m higher than actual environment.

2.3 Installation Inclination Angle Selection

2.3.1 PV modules connected in series should be installed in the same orientation and angle.

2.3.2 If connected to an independent photovoltaic system, the installation angle of the module should be based on the season and light conditions to achieve the maximum power output. At the lowest illumination intensity, if the power generated by module with certain angle can satisfy the lowest power

	Document name	PV Module Installation Instructions		
	Document number	HTL-TR-I062 (V2.4)		
Shanghai Aerospace Automobile Electromechanical Co., Ltd.	Document version	V2.4	Page	8 / 28

generation, it is think that the modules with the certain angle can satisfy the power generation all year around. For grid-connected system, the installation angle of modules depends on the max power generation all year around.

2.4 Choose the Photovoltaic Support

The system designer or installer have responsible for calculation the system load to make sure all module can support the estimated load. The module support manufactures should supply qualified module supports. The support, which is used for photovoltaic system, should has the third test institution certification about static mechanical analysis ability.

2.4.1 Installation of bifacial module without shading the back of module

When designing the modules' support structure, the support components cannot cross the module cell area. The support components can be set up at the edge of the module. At the same time, the inverter should be installed at the side of the module instead of back. If the inverter is installed at the back of the module, it may reduce the reflected light and reduce power generation of the back of the module.

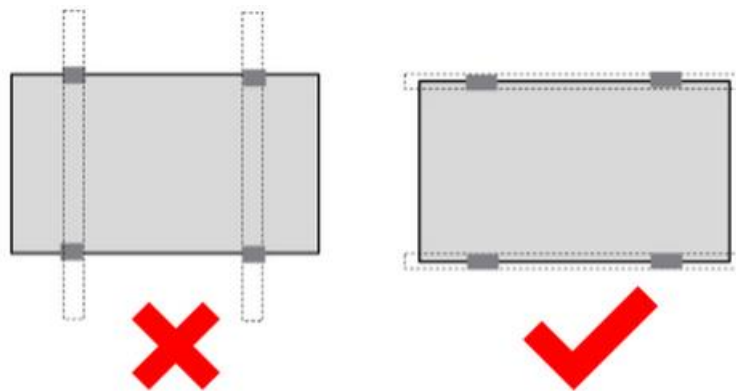



Figure 3 The support components do not cover the back PV module

2.5 Choosing the Photovoltaic Inverter

When choosing photovoltaic inverter, it needs consider the power, open-circuit voltage, short-circuit current of PV modules array. The minimum voltage of the module array should be higher than the threshold voltage of inverters to guarantee the inverters regular work.

2.5.1 Calculation of modules' number in series array

Please use the suitable equipment, connectors, wires and rack which match with solar power system. Please make sure the type of the modules is same in a single PV system. When determining rated voltage,

	Document name	PV Module Installation Instructions		
	Document number	HTL-TR-I062 (V2.4)		
Shanghai Aerospace Automobile Electromechanical Co., Ltd.	Document version	V2.4	Page	9 / 28

wire capacity, fuse, the controller capacity and module output power of relevant parts of PV system, please accord to the short-circuit current (Isc) and open circuit voltage (Voc) showing on modules' label to determine suitable parameters.

In normal outdoor conditions, the current and voltage generated by module may be different from the parameters listed in Table. The parameter list in table is measured under standard test conditions (STC). In different outside climate surrounding, because of different power generation coefficient, the actual parameters, including rated voltage, wire capacity, fuse, the controller capacity and module power output, is different if modules working in different area. In order to get the actual module's electrical parameters, usually, the photovoltaic system designers or installers can use short-circuit current (Isc) and open circuit voltage (Voc) noted on modules' label multiply by 1.25 (redundant value). If the bifacial modules are installed at high reflective surrounding, the redundant value can increase suitably.

Please make sure the system voltage of each modules' array is lower than the maximum voltage of photovoltaic system, rated voltage of inverter and controller. The system current of each modules' array is less than maximum current of photovoltaic system, rated current of inverter and controller.

The connection of modules: According to the system requirement of output voltage and current, modules are connected in series or parallel. The maximum number of series components (N) is recommended to be calculated using the following formula. The number of modules in parallel has relate to the parameters of electrical equipment (such as inverter and controller) in STC.

$$N \leq \frac{V_{max}}{V_{oc} * [1 + T_c(voc) * (T_{min} - 25)]}$$

N Number of modules in series.

Vmax Maximum system voltage

Voc Open circuit voltage of each module(refer to product label or data sheet).

Tc(voc) Thermal coefficient of open circuit voltage for the module(refer to data sheet).

Tmin The lowest ambient temperature.

2.6 Bifacial Module Arrangement and Layout Optimization

Generally, for normal modules' array, there are 2 methods of module connection. The first method

	Document name	PV Module Installation Instructions		
	Document number	HTL-TR-I062 (V2.4)		
Shanghai Aerospace Automobile Electromechanical Co., Ltd.	Document version	V2.4	Page	10 / 28

connects the upper module and the under module in series. The second method separates the upper and the under modules. All upper modules connect in series, and all under modules connect in series separately. There is significant height difference between upper and under modules. The significant height difference lead to light illumination difference between upper and under modules. The light illumination difference lead different working current of the module. If choosing the first method, the under module, which has lower working current, will decrease the working current of the upper module. The decreasing of upper modules' working current will reduce the whole power generation of photovoltaic system. When choosing the second method, the upper modules and the under modules have different working current. It can decrease power loss due to working current mismatch, which improves the advantage of bifacial modules and increases whole power generation of photovoltaic system. The light illumination rises with height increasing at the same outside surrounding. Therefore, the upper modules have higher light illumination than the under modules. In order to declining the current mismatch, we advise the second modules connection method. At the same time, please connect the upper/under modules' array to the different MPPTs of the inverter individually. This is the best method of modules' array connection for photovoltaic system.

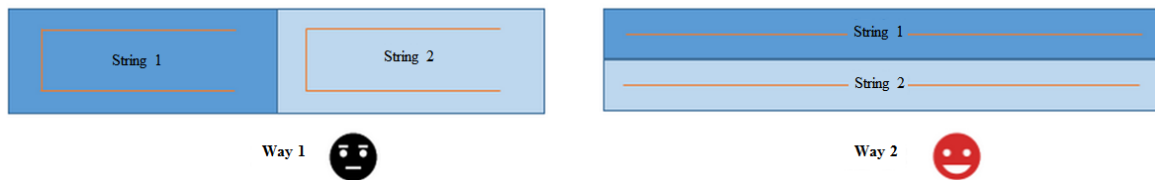

Figure 4 Optimization of modules' array connection

3 Installation

3.1 Installation Safety

3.1.1 Wear protective headgear, insulating gloves and rubber shoes when modules are installed.

3.1.2 During installation, avoid standing on the modules, which will lead to damage of modules, or hazard human safety. Avoid unnecessary touching of modules. The surface and frame of modules may be very hot, which may lead to burn or electric shock.

3.1.3 Don't unpack the outside packing of modules except to install immediately. Avoid installing in rainy, snowy or windy weather.

	Document name	PV Module Installation Instructions		
	Document number	HTL-TR-I062 (V2.4)		
Shanghai Aerospace Automobile Electromechanical Co., Ltd.	Document version	V2.4	Page	11 / 28

3.1.4 In order to reduce hazard of electric shock, if the junction box connectors are wet, stop installing.

3.1.5 During installing, do not throw anything, including modules and installation tools.

3.1.6 Please make sure connecting junction box correctly. Checking wiring status to ensure that all strong connection without broken. Take adequate measure to avoid any scratch which may damage the cables or pressure which may damage the module.

3.1.7 During installation or sunshine, avoid touching the junction boxes or connectors no matter what the modules are connecting with photovoltaic system or not.

3.1.8 Avoid pressing or putting something heavy on the module's surface or distorting the module's frame.

3.1.9 Avoid setting overweight things or hitting on the module's surface glass, which may lead damage or microcrack of the solar cell.

3.1.10 Avoid cleaning the modules with sharp tools, which may lead to scratch on the surface of modules.

3.1.11 Avoid digging holes on the module's frame without permission.

3.1.12 For BIPV or roof application, please installing in plan. Please follow the installation rules of "from top to bottom" or / and "from left to right" as much as possible.

3.2 Modules Unpacking

3.2.1 When the modules arrival to destination, avoid unpacking modules in humid and rainy weather.

3.2.2 After unpacking, the modules should be placed horizontally. Avoid tilt, pressure, leaning on the wall of the modules.

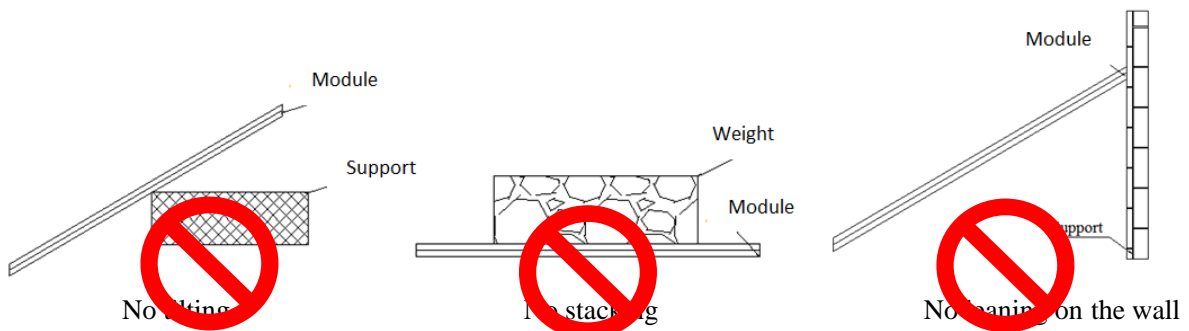



Figure 5 Modules stack illustration

3.2.3 The modules of two batches are separated and stacked neatly. The weight of modules' stack

	Document name	PV Module Installation Instructions		
	Document number	HTL-TR-I062 (V2.4)		
Shanghai Aerospace Automobile Electromechanical Co., Ltd.	Document version	V2.4	Page	12 / 28

should not exceed 20kg. The number of modules per stack is less than 24pcs. If the weight of module exceeds 20kg, the number of modules per stack is less than 20pcs.

3.2.4 Unpacking process should follow the instructions as the figure below. Avoid rude operation or using crowbar to open the boxes. Pay attention to person and modules safety during unpacking.

3.2.5 After unloading, the modules' box should be placed on dry and flat ground, without wet, muddy and uneven ground condition.

3.2.6 After arriving the destination, the upper and lower modules' boxes should be separated and placed separately without stack. If the modules cannot be installed immediately, it should be care to protect the package of modules' boxes. Avoid any packing damage from natural disasters such as rain, snow, hail, typhoon, etc.

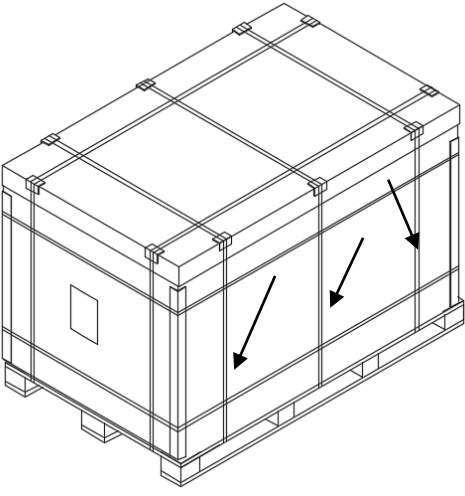
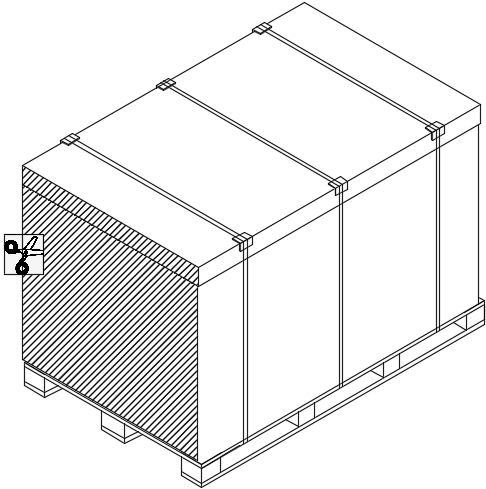
Unpacking process	
	
1. Do not remove the 3 packing belts indicated by the arrow, and remove the other packing belts of the package.	2. Remove one side of the package (shaded part).

	Document name	PV Module Installation Instructions		
	Document number	HTL-TR-I062 (V2.4)		
Shanghai Aerospace Automobile Electromechanical Co., Ltd.	Document version	V2.4	Page	13 / 28
				
3. Cut the two horizontal packing belts in the carton.		4. Disassembly modules from side. According actual surrounding, avoid tipping over or sliding of unpacking modules.		

Figure 6 Unpacking process

3.3 Introduction of Installation Method

The modules can be installed in the following methods: clamp installation and bolt installation.

3.3.1 All installation methods described in this instruction are only for reference. Our company is not responsible for providing relevant installation parts, design and installation of component system.

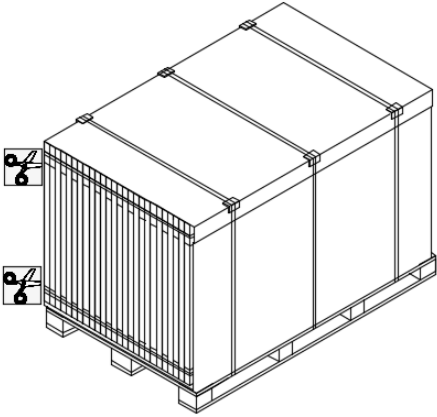
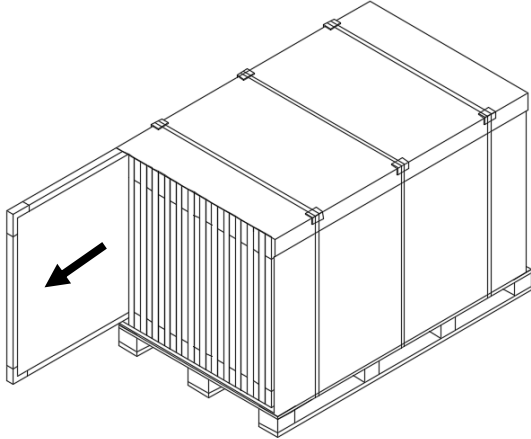
Mechanical loading and safety should be finished by a professional photovoltaic system installer or PV system technicians.

3.3.2 Before installation, the following important items need to be confirmed:

a) Before installation, it is necessary to check than if there is any defects or other foreign matter which is related with appearance and the safety performance of the junction box. If there is any problem, please solve the problem.

b) Please make sure that the serial number of the module is correct.

3.3.3 If the modules are installed in harsh environments, such as snowy or windy, extra measures are needed to protect the modules.

	Document name	PV Module Installation Instructions		
	Document number	HTL-TR-I062 (V2.4)		
Shanghai Aerospace Automobile Electromechanical Co., Ltd.	Document version	V2.4	Page	14 / 28

3.4 Installation of Clamps

It suggests to use M8 bolts for module installation. The clamp or belt used for module installation should overlap the aluminium frame. The width of overlap is between 7 mm (0.28 in) to 10 mm (0.39 in). All the installation methods described here are only for reference. We are not responsible for the design of installation part and photovoltaic system installation. Mechanical load and safety of photovoltaic system must be performed by a professional system installer or someone with special certification.

- Use more than 4 clamps to fix modules on the support.
- Modules' clamps, which used for module installation, can't shadow the front surface glass and distort module's frame.
- Avoid shadow on the surface of modules.
- The module frame is not to be modified under any circumstances.
- The mounting bracket shall not be installed directly below the junction box.

When choosing this type of clamp-mounting method, each module needs 4 clamps at least. Depending on local weather, such as wind and snow condition, additional clamps may be required to ensure that modules have enough support. (In case of severe environment such as storm and heavy snow, it is recommended to use at least 6 clamps for installation. Please contact with our technical support for further information.)

- Applied torque should consider mechanical design standard which accords to the bolt used by customer. e.g:

M8 ---- 16-20 N·m.

The safety factor of mechanical load is 1.5 times.

Component payload = design load * mechanical load safety factor multiple (1.5)

	Document name	PV Module Installation Instructions		
	Document number	HTL-TR-I062 (V2.4)		
Shanghai Aerospace Automobile Electromechanical Co., Ltd.	Document version	V2.4	Page	15 / 28

Method 1:

Installation of long side pressing block, design load ≤ 2400 Pa (front), 1600 Pa (back)

(Use 4 clamps- length of blocks ≥ 50 mm)

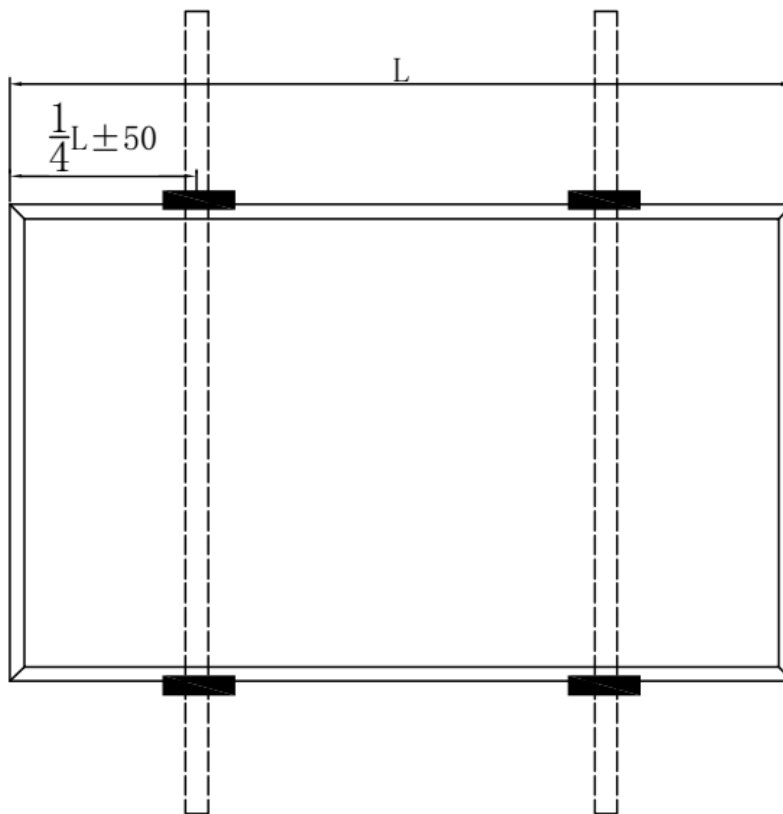

NO.	L*W(mm)
1	1324*992
2	1640*826
3	1640*992
4	1650*992
5	1665*992
6	1665*1002
7	1684*1002
8	1755*1038
9	1775*1052
10	1924*1038
11	1956*992
12	1979*1002
13	1987*992
14	2008*1002
15	2094*1038
16	2115*1052
17	1724*765
18	1722*1134
19	1909*1134
20	2094*1134

Notes:

1.L is the length of PV module. W is the wide of module. The black shadow is the area of installation.

2. The safety factor of mechanical load is 1.5 times.

	Document name	PV Module Installation Instructions		
	Document number	HTL-TR-I062 (V2.4)		
Shanghai Aerospace Automobile Electromechanical Co., Ltd.	Document version	V2.4	Page	16 / 28

Method 2:

Installation of long side pressing block, design load ≤ 3600 Pa (front), 1600 Pa (back)

(Use 6 clamps- length of blocks ≥ 50 mm)

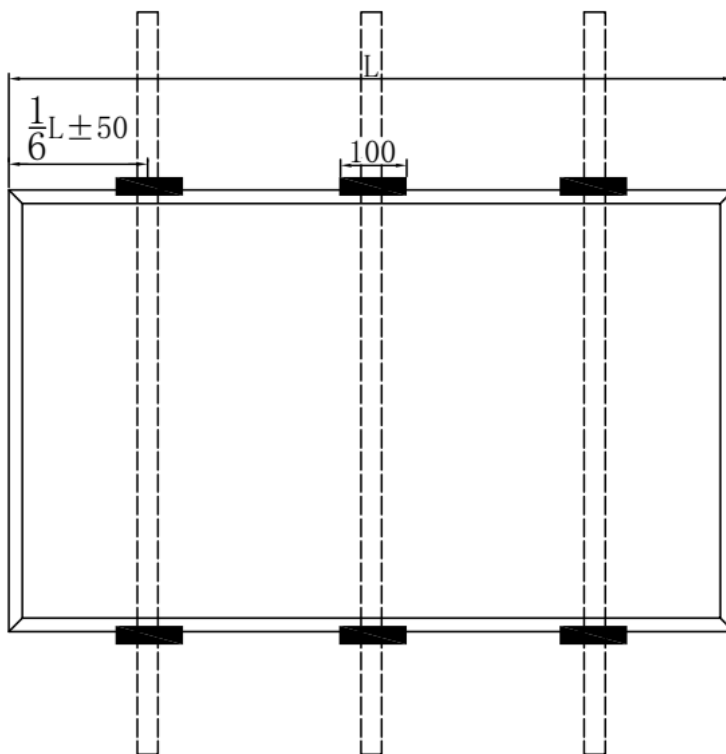

NO.	L*W(mm)
1	1324*992
2	1640*826
3	1640*992
4	1650*992
5	1665*992
6	1665*1002
7	1684*1002
8	1755*1038
9	1775*1052
10	1924*1038
11	1956*992
12	1979*1002
13	1987*992
14	2008*1002
15	2094*1038
16	2115*1052
17	1724*765
18	1722*1134
19	1909*1134
20	2094*1134

Notes:

1. .L is the length of PV module. W is the wide of module. The black shadow is the area of installation.
2. The safety factor of mechanical load is 1.5 times.

	Document name	PV Module Installation Instructions		
	Document number	HTL-TR-I062 (V2.4)		
Shanghai Aerospace Automobile Electromechanical Co., Ltd.	Document version	V2.4	Page	17 / 28

Method 3:

Installation of short side pressing block, design load ≤ 1600 Pa (front), 1600 Pa (back)

(Use 4 clamps- length of blocks ≥ 50 mm)

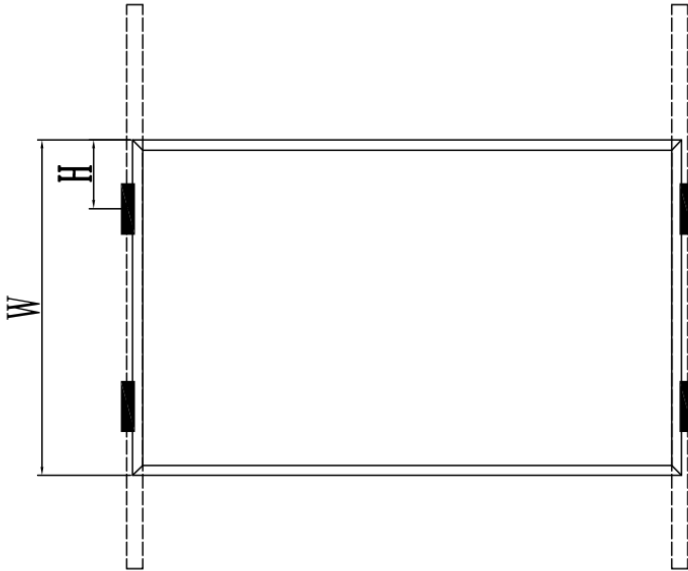
	NO.	L*W(mm)
		1
	2	1640*826
	3	1640*992
	4	1650*992
	5	1665*992
	6	1665*1002
	7	1684*1002
	8	1755*1038
	9	1775*1052
	10	1924*1038
	11	1724*765
	12	1722*1134
	13	1909*1134

Notes:

1. L is the length of PV module. W is the wide of module. The black shadow is the area of installation.
2. The safety factor of mechanical load is 1.5 times.

	Document name	PV Module Installation Instructions		
	Document number	HTL-TR-I062 (V2.4)		
Shanghai Aerospace Automobile Electromechanical Co., Ltd.	Document version	V2.4	Page	18 / 28

Method 4 (18X module, 72 and 78 board type) :

Installation of long side pressure block , design load ≤ 2400 Pa (front), 1600 Pa (back), (Use 4 clamps-length of blocks ≥ 50 mm)

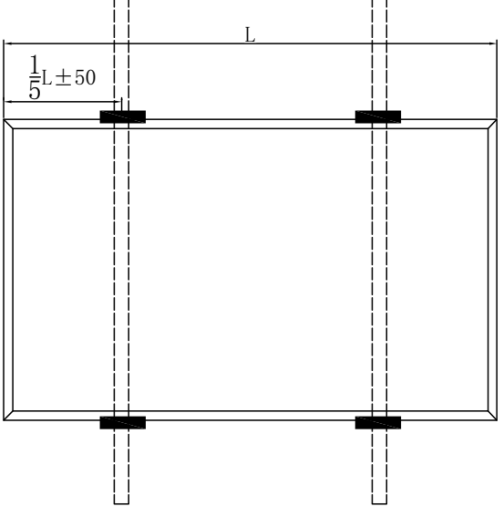
	1	2278*1134
	2	2465*1134

Notes:

1. L is the length of PV module. W is the wide of module. The black shadow is the area of installation.
2. The safety factor of mechanical load is 1.5 times.

Method5 (18X module, 72 and 78 board type) :

Installation of long side pressure block , design load ≤ 3600 Pa (front), 1600 Pa (back),(Use 6 clamps-length of blocks ≥ 50 mm)

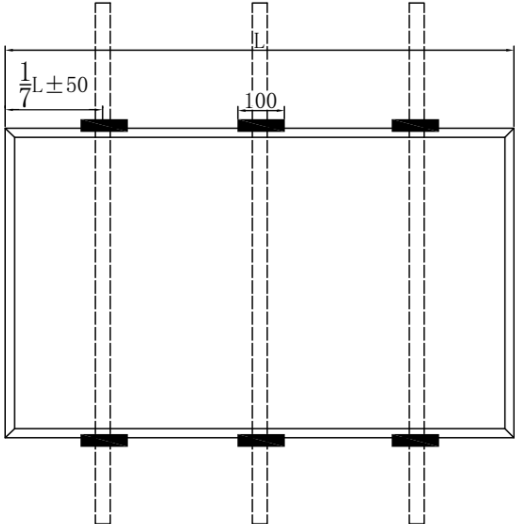
	1	2278*1134
	2	2465*1134

Notes:

- 1.L is the length of PV module. W is the wide of module. The black shadow is the area of installation.

	Document name	PV Module Installation Instructions		
	Document number	HTL-TR-I062 (V2.4)		
Shanghai Aerospace Automobile Electromechanical Co., Ltd.	Document version	V2.4	Page	19 / 28

2. The safety factor of mechanical load is 1.5 times.

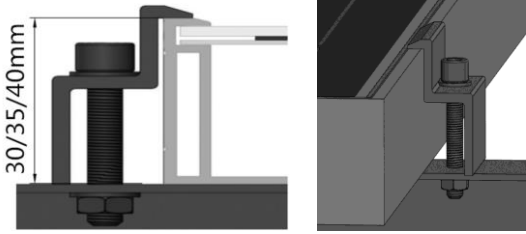
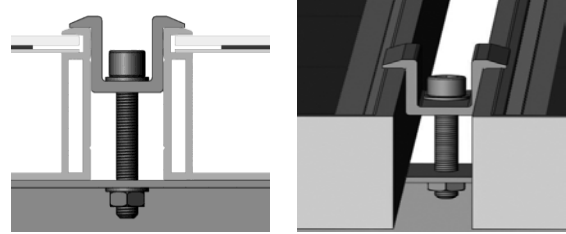
End clamp installation(30/35/40mm optional)	Middle clamp installation
	
PV module installed with clamp fitting method.	

3.5 Installation of Bolts

The frame of each module has several $14 \times 9\text{mm}$ mounting holes. Ideally, the position of holes have ability to optimize the load distribution, to achieve great and strong module support structure.

In order to extend the life of module support, we advise to use anti-corrosion bolts or clamps (stainless steel) strongly.

Use M8 bolt and flat washer, spring washer and nut as shown in Figure 7 in each block. Tighten the bolts until the torque reaching 16-20 N·m.

	Document name	PV Module Installation Instructions		
	Document number	HTL-TR-I062 (V2.4)		
Shanghai Aerospace Automobile Electromechanical Co., Ltd.	Document version	V2.4	Page	20 / 28

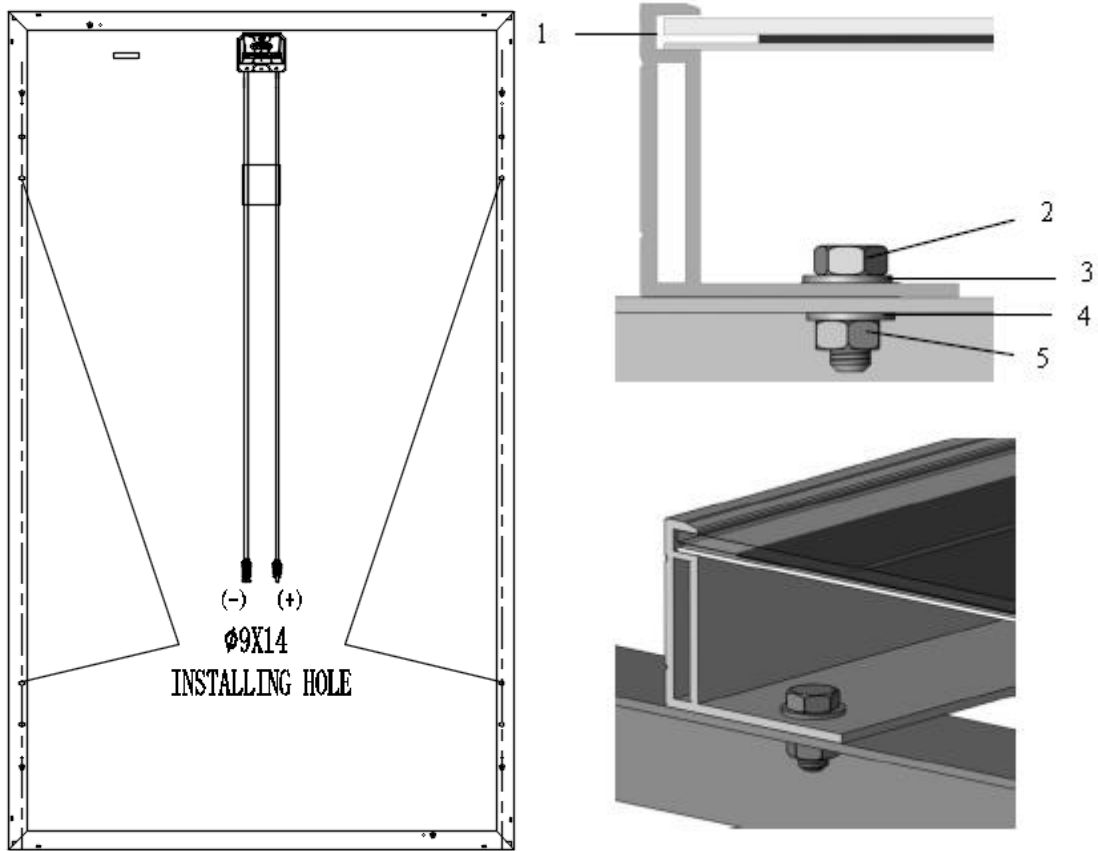

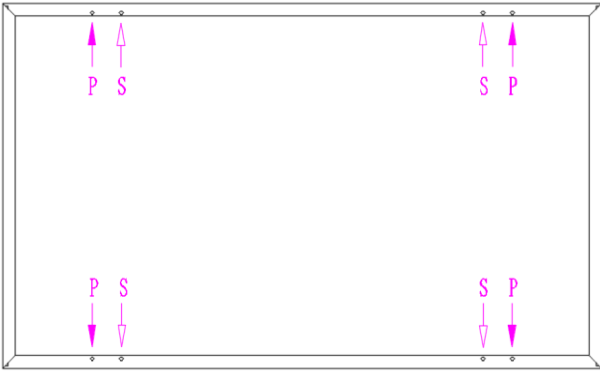

Figure 7. SPV module installed with Bolt fitting method

- | | |
|-------------------------|---------------------------|
| 1 Aluminum Frame | 2 M8 Stainless bolt |
| 3 Flat Stainless Washer | 4 Spring Stainless Washer |
| 5 HEX Stainless Nut | |

	Document name	PV Module Installation Instructions		
	Document number	HTL-TR-I062 (V2.4)		
Shanghai Aerospace Automobile Electromechanical Co., Ltd.	Document version	V2.4	Page	21 / 28

Installation of Bolts				
NO.	L*W(mm)	Design Load \leq 1600Pa (front), 1200 Pa (back)	Design Load \leq 3600Pa (front), 2400 Pa (back)	
		Use 4 installation holes with S or P holes	Use 8 installation holes with S and P holes	
1	1324*992			
2	1640*826			
3	1640*992			
4	1650*992			
5	1665*992			
6	1665*1002			
7	1684*1002			
8	1755*1038			
9	1775*1052			
10	1924*1038			
11	1956*992			
12	1979*1002			
13	1987*992			
14	2008*1002			
15	2094*1038			
16	2115*1052			
17	1724*765			
18	1722*1134			
19	1909*1134			
20	2094*1134			
21	2278*1134			
22	2465*1134			

3.6 Installation of Single-axis Tracking System

In some special type of modules, there are installation holes on the frame, which use for installation of single-axis tracking system. These installation holes, including normal holes and single-axis tracking holes, is good for press distribution and achieve strong support structure. With help of installation holes on the aluminum frame of the module, bolts can be used to connect module and support. The detail of installation is showed in follow figure. Use M6 bolt and a flat washer, spring washer and nut for connection between

	Document name	PV Module Installation Instructions		
	Document number	HTL-TR-I062 (V2.4)		
Shanghai Aerospace Automobile Electromechanical Co., Ltd.	Document version	V2.4	Page	22 / 28

modules and supports. Tighten the bolts until the torque reach 16-20N.m (0.63-0.79 inches). The modules connected with single-axis tracking system needs special stainless steel washers with a minimum thickness of 1.5mm and an external diameter of 16-20mm (0.63-0.79 inches). In these install method, the maximum design load of the front is 1200pa, the design load of the back is 1200pa, and the safety factor is 1.5 times. Component payload = design load * mechanical load safety factor multiple (1.5).

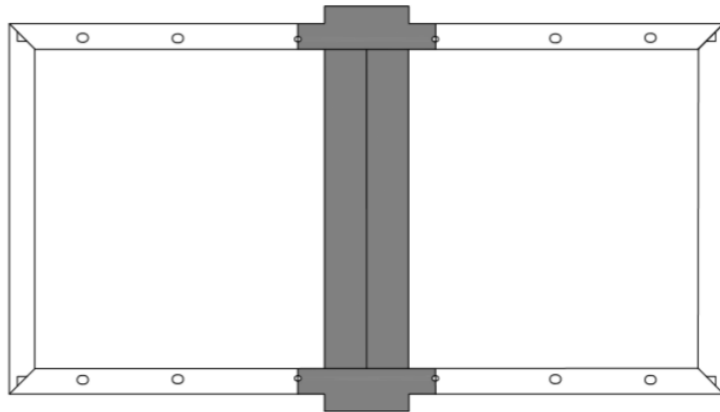

Figure 8 Installation diagram of module with single-axis tracking system

4 Electrical Connection

4.1 Precautions for Electrical Connection

4.1.1 Please read the electrical wiring drawings carefully before wiring. The wiring should accord to local law and program and be operated by certificated electricians. The maximum voltage of the system must be lower than the maximum certified voltage and the maximum input voltage of the inverter and other electrical devices installed in the system.

4.1.2 The connection between module and junction box: the module is connected with junction box by the dc cable. The cross-sectional area of cable and the connector capacity must be satisfied with the system's short circuit current. The cable's cross-sectional area for a single module is recommended to be 4mm². The fuse current and the rated current of the connector should be higher than 20A(18X series module s and double-sided modules should be $\geq 25A$). Otherwise, the cables and connectors will overheat due to high current. Please note that the highest temperature of cable is 90 °C, and the highest temperature of connector is 125 °C.

4.1.3 The aluminum frame and support of the module must be grounded, as shown in Figure 9. Each

	Document name	PV Module Installation Instructions		
	Document number	HTL-TR-I062 (V2.4)		
Shanghai Aerospace Automobile Electromechanical Co., Ltd.	Document version	V2.4	Page	23 / 28

module has a grounding hole and is marked on the frame (it is recommended that the series / parallel connection of each module must be grounded once). The installation method of grounding bolt is shown in FIG. 10. The grounding wire and frame can be reliably grounded by the prepared grounding hole. And the flat washers, spring washers and nuts are matched by installing bolts M5 × 10 ~ 15. The modules and the earth wire shall be perfectly connected by connecting plugs. Negative grounding inverter can be installed to prevent PID phenomenon.

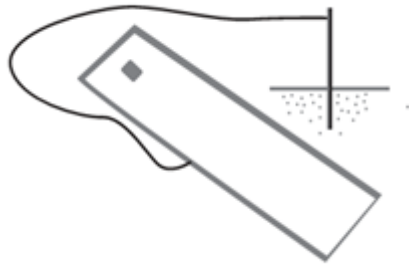

Figure 9 Module grounding circuit

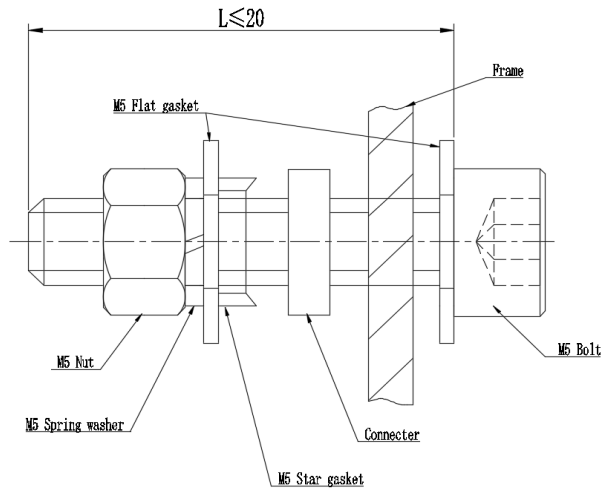

Figure 10 Installation diagram of grounding bolt

4.1.4 Common hardware parts, such as nuts, bolts, star washers, lock washers, flat washers, are used for grounding/connecting. The installation of such hardware parts should comply with instructions of manufacturers.

4.1.5 The common grounding parts, such as nuts, bolts, star washers, lock washers, which have not been evaluated for electrical conductivity, are only to use for mechanical connection. And the grounding parts of the module should keep suitable conductivity. These grounding parts, which supply the evaluation of UL 1703 as the same as modules, can use for module's installation according to installation instruction.

4.1.6 The electrical connection shall conform to local electrical laws and regulations. Avoid "Y" type electrical connection mode in module system electrical connection.

4.1.7 Modules are equipped with bypass diodes (rated voltage 45V, rated current 25A). The improper installation may damage diodes, cables or junction box.

4.1.8 If the modules unpack without installation immediately, please protect module connectors in order to avoid damage due to wind or rain. Avoid lubricant on module's connectors. The connectors shall

	Document name	PV Module Installation Instructions		
	Document number	HTL-TR-I062 (V2.4)		
Shanghai Aerospace Automobile Electromechanical Co., Ltd.	Document version	V2.4	Page	24 / 28

not be exposed to the sun

4.1.9 Avoid removing the waterproof rubber rings out from the junction box or connectors.

4.1.10 Avoid using diesel oil to keep warm in installation site, because the gas generated by diesel oil or other petroleum products may destroy module's connector.

4.1.11 The minimum bending radius cables should be 43mm (1.69in).



4.2 Wiring and Connections

4.2.1 When the long side of module is perpendicular to the ground, if there is only a row of modules, the cables which connect adjacent modules can be short. If there are two row modules, which long sides are perpendicular to ground, it needs a special jump cable to connect up and down modules. Please do not ignore the jump cable during 2 row modules system design. Generally, the standard wire length of 60 plate type integrated junction box is 0.9m. The standard wire length of 72 plate type junction box is 1.1m. If the module has separated junction boxes, the standard wire length of each separated junction box is 0.2m (positive) and 0.3m (negative) respectively. The wire length of other large-size plate and special plate components shall be subject to the corresponding product parameter manual.

When modules are in series connection, the string voltage is sum of every individual module in one string. When modules are in parallel connection, the current is sum of the individual module. Modules with different electric performance models can not be connected in one string.

	Document name	PV Module Installation Instructions		
	Document number	HTL-TR-I062 (V2.4)		
Shanghai Aerospace Automobile Electromechanical Co., Ltd.	Document version	V2.4	Page	25 / 28

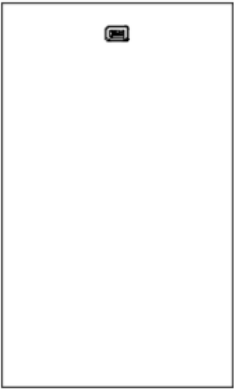
Recommended wiring method:

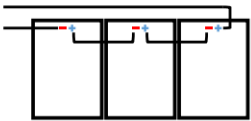
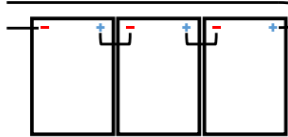
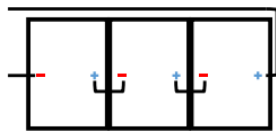
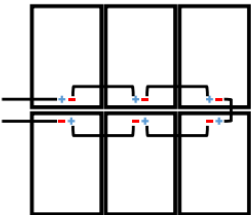
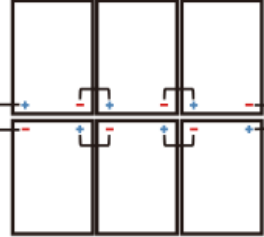
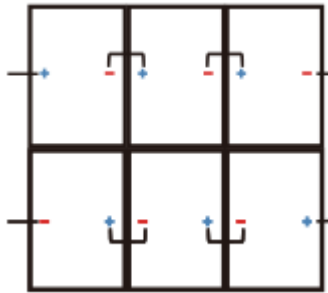
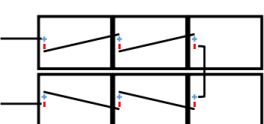
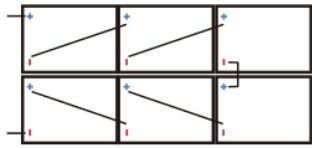
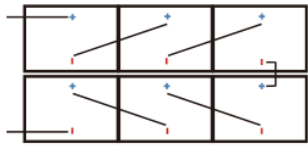
Junction box position style 1	Junction box position style 2	Junction box position style 3
		
Single row installation with long side of modules perpendicular to the ground		
		
Two row module installation		
		
Two row module installation with long side parallel to the ground		
		

If there has reverse current exceeding the maximum fuse current flowing through the module, use overcurrent protection device with the same specifications to protect the module. If quantity of parallel connection is more than 2, there must be an overcurrent protection device on each string of module.

	Document name	PV Module Installation Instructions		
	Document number	HTL-TR-I062 (V2.4)		
Shanghai Aerospace Automobile Electromechanical Co., Ltd.	Document version	V2.4	Page	26 / 28

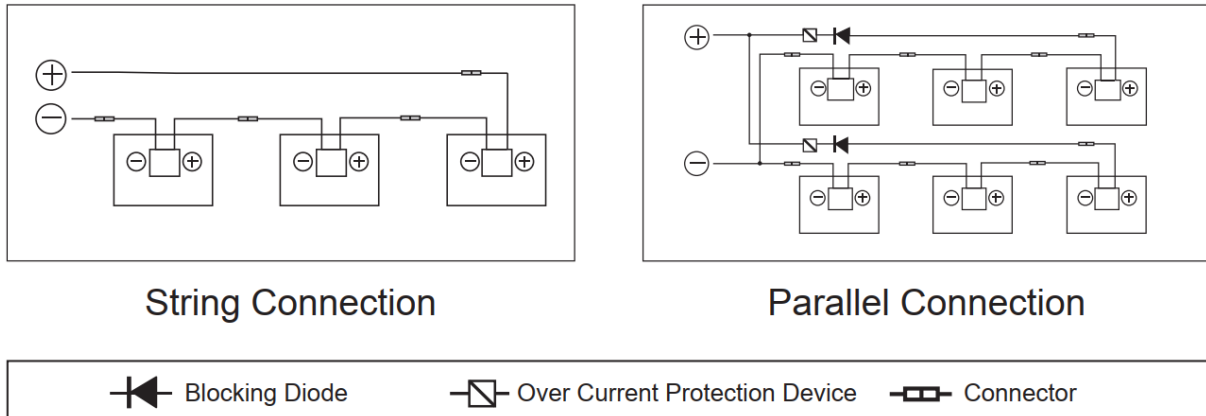

Figure 11 Series connection and parallel connection circuit diagram

4.3 Structure of PV station

The following figure shows the structure of a simple PV station. The mounting design must be certified by a registered professional engineer. The mounting design and procedures must comply with all applicable local codes and requirements from all relevant authorities.

5 Maintenance

The modules need to be inspected and maintained regularly, including visual inspection and all electrical connections to ensure that there is stable connection without any broken.

- Check the open circuit voltage of each module:
- Cover the front surface of modules with an opaque material. There is hazard voltage if modules exposed in light illumination.
- Disconnect the wires from both sides of the module.
- Remove the non-transparent material off the modules; check and measure the open circuit voltage of the modules.
- If the measured voltage is reduced by 1/4, it supposed to be bypass diode damaged. Please test the bypass diode performance.
- It's recommend that adopt the following maintenance to ensure the modules maintain the best performance:

Check whether the modules have any appearance defect: such as surface damage, abnormal or shadow.

	Document name	PV Module Installation Instructions		
	Document number	HTL-TR-I062 (V2.4)		
Shanghai Aerospace Automobile Electromechanical Co., Ltd.	Document version	V2.4	Page	27 / 28

Make sure that the module support system is stable without any loose part. If finding any abnormal situation, please contact professionals to adjust or repair.

- Clean modules at least one time each year, depending on local conditions. If the surface of the module becomes dirty, the power generation of the modules reduces. In this situation, you can use soft sponge or water to clean the surface glass of the module. Mild, non-abrasive chemical cleaners can be used to help washing modules. Avoid using any corrosion chemical cleaners. In order to reduce electric shock or burns, it is recommended to clean modules in the morning or evening.

- Check mechanical and electrical property of modules every six months to ensure the modules' connectors clean and reliable. And ensure good electrical connection and no corrosion.

- If you have any questions, please contact with professionals and arrange further check.

- Please note that all maintenance instructions, such as brackets, charging rectifier, inverters and batteries, should be complied.

- Meaning of crossed –out wheeled dustbin:



Do not dispose of electrical appliances as unsorted municipal waste, use separate collection facilities.

Contact your local government for information regarding the collection systems available.

If electrical appliances are disposed of in landfills or dumps, hazardous substances can leak into the groundwater and get into the food chain, damaging your health and well-being.

When replacing old appliances with new ones, the retailer is legally obligated to take back your old appliance for disposals.

6 Disclaimer

Because the use of the manual and the conditions or methods of installation, operation, use and maintenance of photovoltaic (PV) product are beyond the control of Shanghai Aerospace Automobile Electromechanical Co., Ltd. We do not accept responsibility and expressly disclaims liability for loss, damage, or expense arising out of or in any way connected with such installation, operation, use or

	Document name	PV Module Installation Instructions		
	Document number	HTL-TR-I062 (V2.4)		
Shanghai Aerospace Automobile Electromechanical Co., Ltd.	Document version	V2.4	Page	28 / 28

maintenance.

No responsibility is assumed by Shanghai Aerospace Automobile Electromechanical Co., Ltd.

for any infringement of patents or other rights of third parties, which may result from use of the PV product. NO license is granted by implication or otherwise under any patent or patent rights.

The information in this manual is based on our knowledge and experience and is believed to be reliable, but such information including product specification (without limitations) and suggestions do not constitute a warranty, expresses or implied. We reserve the right to change the manual, the PV produce, the specifications, or product information sheets without prior notice.

Importer information

Company: ASC Energy Pty Ltd.

ABN: 99156499133

Web: ascenergy.com.au

Email: info@ascenergy.com.au

Tel: 1300 309 008

Address: 82/330 Wattle St, Ultimo NSW 2007

Shanghai Aerospace Automobile Electromechanical Co., Ltd.

Address: 222 Caoxi Rd, 8th Floor of Spaceflight Building, Shanghai ,P.R. China

Website: www.ht-saae.com

Email: pvmarketing@ht-saae.com

Tel: +8621- 64828990

Note:

The above terms are written in both Chinese and English if there is any discrepancy between the Chinese version and English version, the company reserves the right of final interpretation if there is any discrepancy.