

User manual

Energy storage integrated inverter

Product Model: HYD 5K~20KTL-3PH



Content

1. Basic safety information.....	- 1 -
1.1. Safety instructions.....	- 1 -
1.2. Symbols and signs.....	- 4 -
2. Product characteristics.....	- 6 -
2.1. Product informations.....	- 6 -
2.2. Size description.....	- 7 -
2.3. Function characteristics.....	- 7 -
2.4. Electrical block diagram.....	- 7 -
3. Application modes.....	- 9 -
3.1. Typical Energy Storage System.....	- 9 -
3.2. System Without PV Connection.....	- 10 -
3.3. System Without Battery.....	- 11 -
3.4. Back-up Mode (Without Grid).....	- 12 -
3.5. System With Multi Inverters.....	- 13 -
3.6. AC Retrofit System.....	- 15 -
3.7. Back-up Unbalanced Output.....	- 17 -
3.8. On-Grid Unbalanced Output.....	- 18 -
4. Installation.....	- 19 -
4.1. Installation Process.....	- 19 -
4.2. Checking Before Installation.....	- 19 -
4.3. Product Overview.....	- 22 -
4.4. Tools.....	- 22 -
4.5. Installation Environment.....	- 23 -
4.6. Determining the Installation Position.....	- 24 -
4.7. Moving the HYD 5-20KTL-3PH.....	- 25 -
4.8. Installing HYD 5-20KTL-3PH.....	- 26 -
5. Electrical Connections.....	- 28 -
5.1. Wire instructions.....	- 30 -
5.2. Connecting PGND Cables.....	- 30 -
5.3. Battery Connection &PV Connection.....	- 32 -
5.4. AC Load connection.....	- 33 -

5.5. AC Grid connection.....	- 34 -
5.6. External communication interface.....	- 35 -
5.7. Communication method.....	- 50 -
6. Buttons and indicator lights.....	- 52 -
6.1. Buttons.....	- 52 -
6.2. Indicator lights and status.....	- 52 -
7. Operation (commission)	- 53 -
7.1. Double Check.....	- 53 -
7.2. First Time Setup (Starting up Or Shutdown).....	- 53 -
7.3. Setting power quality response modes.....	- 58 -
7.4. Menu.....	- 59 -
8. Troubleshooting.....	- 77 -
9. Technical Data.....	- 85 -
10. Quality Assurance.....	- 92 -

Notice

This manual contains important safety instructions that must be followed during installation and maintenance of the equipment.

Save these instructions!

This manual must be considered as an integral part of the equipment. The manual must always accompany the equipment, even when it is transferred to another user or field.

Copyright Declaration

The copyright of this manual belongs to Shenzhen SOFARSOLAR Co., Ltd. Any corporation or individual should not plagiarize, partially copy or fully copy it (including software, ect .),and no reproduction or distribution of it in any form or by any means. All right reserved.

SOFARSOLAR reserves the right of final interpretation. This manual is subject to change according to user's or customer's feedback. Please check our website at <http://www.sofarsolar.com> for latest version.

Document Updates

V1.1 2022-6-17

- Initial versio7

Shenzhen SOFARSOLAR Co., Ltd

Location:11/F., Gaoxinqi Technology Building, No.67 Area, Xingdong Community, Xin'an Sub-district, Bao'an District, Shenzhen City,China

Postcode: 518000

Company Website: www.sofarsolar.com

Email: service@sofarsolar.com

Preface

**Note**

If you have any question or problem when you read the following information, please contact Shenzhen SOFARSOLAR Co., Ltd.

Outline

Please read the product manual carefully before installation, operation or maintenance. This manual contains important safety instructions and installation instructions that must be followed during installation and maintenance of the equipment.

Scope

This product manual describes the installation, electrical connections, commissioning, maintenance and troubleshooting of HYD 5-20KTL-3PH inverters:

HYD 5KTL-3PH	HYD 6KTL-3PH
HYD 8KTL-3PH	HYD 10KTL-3PH
*HYD 10KTL-3PH-A	
HYD 15KTL-3PH	HYD 20KTL-3PH





Keep this manual where it will be accessible at all times.

Target Group

This manual is intended for qualified electrical technical personnel who are responsible for inverter installation and commissioning in the PV power system and PV plant operator.

Symbols Used

This manual provides safety operation information and uses the symbol in order to ensure personal and property security and property security and use inverter efficiently when operating the inverter. You must understand these emphasized information to avoid the personal injury and property loss. Please read the following symbols used in this manual carefully.

 Danger	<p>"Dangerous" means there is a high potential danger that, if not avoided, could result in death or injury.</p>
 Warning	<p>"Warning" indicates a moderate potential danger that, if not avoided, could result in death or injury.</p>
 Caution	<p>"Caution" indicates a mild potential hazard that, if not avoided, could result in moderate or mild injury to persons.</p>
 Attention	<p>"Attention" denotes potential risk, if not avoided, that may result in equipment not operating properly or property damage.</p>
 Note	<p>"Note" are additional information in the manual, highlighting and complements the content, and may also provide tips or tricks for optimizing the use of the product that can help you solve a problem or save you time.</p>

1. Basic safety information

1.1. Safety instructions

Read and understand the instructions of this manual, and be familiar with relevant safety symbols in this chapter, then start to install and troubleshoot the equipment.

According to the national and state requirements, before connecting to the electrical grid, you must get permission from the local electrical grid operation can only be performed by qualified electrical engineer.

Please contact the nearest authorized service center if any maintenance or repair is needed. Contact your distributor for the information of the nearest authorized service center. Do NOT repair it by yourself, it may cause injury or property damage.

Before installing and maintaining the equipment, you should turn the DC switch OFF to cut off the high voltage DC of the PV array. You can also turn the switch in the PV combiner box OFF to cut off the high voltage DC. When the battery needs to be installed, please confirm the positive and negative terminals of the battery and turn OFF the battery. Otherwise, serious injury may be caused.

Qualified persons

The customer must make sure the operator has the necessary skill and training to do his/her job. Staff in charge of using and maintaining the equipment must be skilled, aware and mature for the described tasks and must have the reliability to correctly interpret what is described in the manual. For safety reason only a qualified electrician, who has received training and / or has demonstrated skills and knowledge in construction and in operation of this unit, can install this inverter. Shenzhen SOFARSOLAR Co., Ltd. does not take any responsibility for the property destruction and personal injury because of any incorrect use.

Installation requirements

Please install inverter according to the following section. Fix the inverter on an appropriate objects with enough load bearing capacity (such as walls, PV racks etc.), and ensure that inverter is vertical placed. Choose a place suitable for

installing electrical devices. And assure there is enough fire exit space, convenient for maintenance. Maintain proper ventilation to ensure enough air cycle to cool the inverter.

Transport requirements

If you find packing problems that may cause the damage of the inverter, or find any visible damage, please immediately notice the responsible transportation company. You can ask solar equipment installation contractor or Shenzhen SOFARSOLAR Co., Ltd. for help if necessary.

Transport of the equipment, especially by road, must be carried out with by suitable ways and means for protecting the components (in particular, the electronic components) from violent shocks, humidity, vibration, etc.

Labels on the equipment

The labels must NOT be hidden with objects and extraneous parts(rags, boxes, equipment, etc.);they must be cleaned regularly and kept visible at all times.

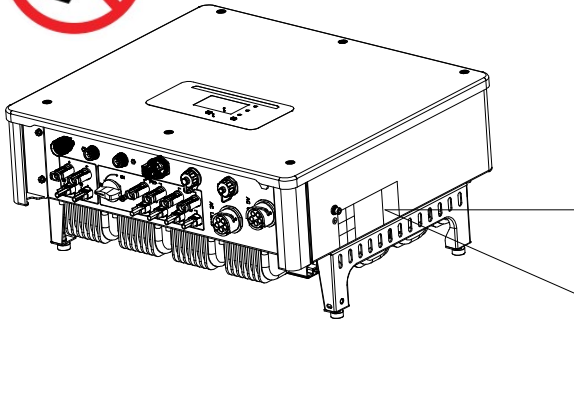

SOFAR SOLAR
Hybrid Inverter

Model No: HYD 20KTL-3PH

Max DC Voltage	1000V
MPPPT Voltage Range	140-980V
Max Input Current	25/25A
Max P/In	10/10A
Battery Type	LiFePO4
Battery Voltage Range	10-90V
Battery Max. Charging Current	25/25A
Battery Max. Discharging Current	25/25A
Rated Grid Back-up Voltage	±10% UNPE 200V/240V
Rated Grid Back-up Frequency	50/60Hz
Rated Current Output To Grid	±30A
Max. Current Output to Grid	±32A
Rated Apparent Power Output to Grid	20000VA
Max. Power Output to Grid	20000W
Max. Current Input Grid	±32A
Max. Power Input from Grid	20000VA
Back-up Max. Output Current	±32A
Back-up Max. Output Power	20000W
Power Factor	1 (adjustable 0.9)
Operating Temperature Range	-20~40°C
Ingress Protection	IP65
Protective Class	Class II
Inverter Topology	Non-Isolated
Overvoltage Category	AC III DC II



Manufacturer : Shenzhen SOFARSOLAR Co., Ltd.
 Address : 11/F, Geoxing Technology Building, No.67
 Area: Xiangtang Community, Xin'an Sub-district,
 Bao'an District, Shenzhen City, China
 SAA VDE126-1 VDE-AR-N4105
 CE, G99, EN60947-1, EN61727, IEC 61727-2-1
 CEI-16/CEI-21, IEC61727, IEC62116

Electric connection



Please comply with all the current electrical regulations about accident prevention in dealing with the solar invert.





Before the electrical connection, make sure to use opaque material to cover the PV modules or to disconnect PV array DC switch. Exposure to the sun, PV array will produce a dangerous voltage!

	<p>All installation accomplished only by professional electrical engineer! Must be trained;</p>
<p>Warning</p>	<p>Completely read the manual operation and understand relevant matter.</p>
	<p>Get permission from the local electrical grid operator, complete all electrical connections by professional electrical engineer, then connect inverter to electrical grid.</p>
	<p>It's forbidden to remove the tamper evident label, or open the inverter. Otherwise SOFARSOLAR will not provide warranty or maintenance!</p>
<p>Note</p>	

Operation

	<p>Touching the electrical grid or the terminal of the equipment may lead to electrocution or fire! Don't touch the terminal or conductor connected to the electrical grid.</p>
<p>Danger</p>	<p>Pay attention to any instructions or safety documents related to grid connection.</p>
	<p>Some internal components will be very hot when inverter is working. Please wear protective gloves!</p>
<p>Attention</p>	<p>Keep it away from kids !</p>

Maintenance and repair

	<p>Before any repair work, turn OFF the AC circuit breaker between the inverter and electrical grid first, then turn OFF the DC switch. After turning OFF the AC circuit breaker and DC switch, wait for 5 minutes at least before carrying out any maintenance or repair work.</p>
<p>Danger</p>	
	<p>Inverter should work again after removing any faults. If you need any repair work, please contact with the local authorized service center.</p>
<p>Attention</p>	<p>Can't open the internal components of inverter without authorized. Shenzhen SOFARSOLAR Co., Ltd. does not take any responsibility for the losses from that.</p>



EMC / noise level of inverter

Electromagnetic compatibility (EMC) refers to that one electrical equipment functions in a given electromagnetic environment without any trouble or error, and impose no unacceptable effect upon the environment. Therefore, EMC represents the quality characters of an electrical equipment. The inherent noise-immune character: immunity to internal electrical noise. External noise immunity: immunity

to electromagnetic noise of external system. Noise emission level: influence of electromagnetic emission upon environment.







	<p>Electromagnetic radiation from inverter may be harmful to health! Please do not continue to stay around the inverter in less than 20 cm when inverter is working.</p>
Danger	





1.2. Symbols and signs

	<p>Caution of burn injuries due to hot enclosure! You can only touch the screen and pressing key of the inverter while it's working.</p>
Caution	
	<p>PV array should be grounded in accordance to the requirements of the local electrical grid operator! We suggest that all PV module frames and inverter are reliably grounded to protect the PV system and personnel security.</p>
Attention	
	<p>Ensure input DC voltage < Max. DC voltage .Over voltage may cause permanent damage to inverter or other losses, which will not be included in warranty!</p>
Warning	

Signs on the inverter

There are some symbols which are related to security on the inverter. Please read and understand the content of the symbols, and then start the installation.

	<p>This symbol indicates a hazardous situation which could result in injuries, if not avoided.</p>
	<p>There is a residual voltage in the inverter! Before opening the equipment, operator should wait for five minutes to ensure the capacitor is discharged completely.</p>
	<p>Caution, risk of electric shock.</p>
	<p>Caution hot surface.</p>
	<p>Comply with the Conformance Europeenne (CE) certification.</p>
	<p>Grounding point.</p>
	<p>Please read this manual before install HYD 5-20KTL-3PH.</p>

	<p>This indicates the degree of protection of the equipment according to IEC standard 70-1 (EN 60529 June 1997).</p>
	<p>Positive pole and negative pole of the input voltage (DC).</p>
	<p>This side up, HYD 5-20KTL-3PH inverter must always be transported, handled and stored in such a way that the arrows always point upwards.</p>
	<p>RCM (Regulatory Compliance Mark) The product complies with the requirements of the applicable Australian standards.</p>

2. Product characteristics

2.1. Product informations

HYD 5-20KTL-3PH inverter is a three-phase photovoltaic energy storage inverter integrating grid-connected photovoltaic inverter and battery energy storage.

The HYD 5-20KTL-3PH inverter has a variety of built-in operating modes to suit the diverse user needs.

The HYD 5-20KTL-3PH inverter can provide a complete solution in the period of rising energy costs such as oil and coal, the energy subsidy of photovoltaic grid-connected system keeps falling. In the period of continuous power supply and emergency power supply demand in mountainous areas or base stations without power grid.

Fig. 2-1 HYD 5-20KTL-3PH inverter system diagram

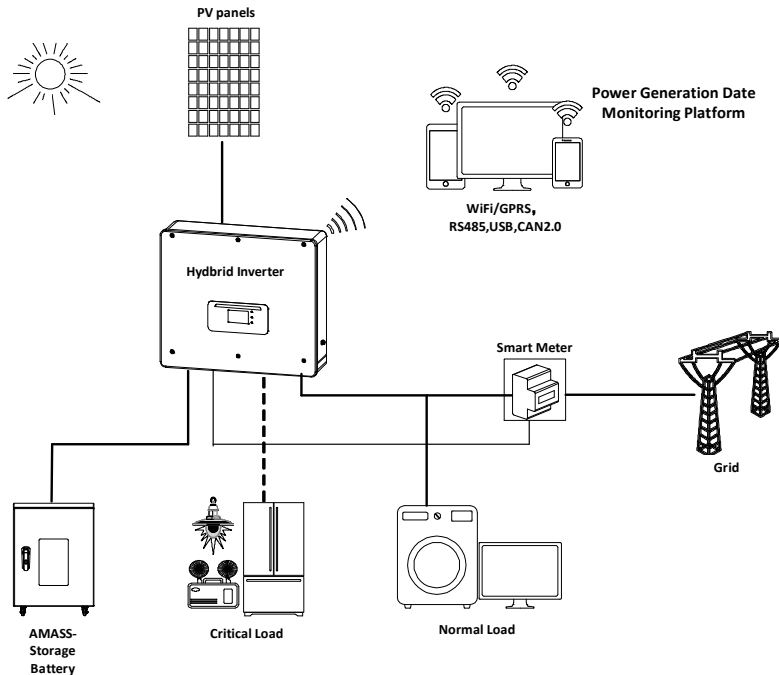

2.2. Size description

Fig. 2-2 Size chart

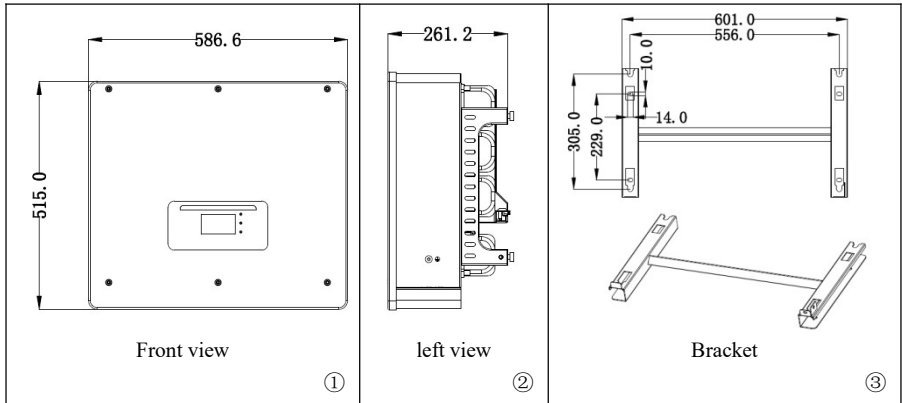

2.3. Function characteristics

The HYD 5-20KTL-3PH energy storage inverters allow up to 10% overloading to maximize power output, and the Uninterruptible Power Supply (UPS) mode can support inductive loads such as air conditioners or refrigerators with an automatic switchover time of less than 10 milliseconds.

- a. Dual MPP trackers with 1.5* DC overload.
- b. Flexible switching between grid-tied mode and energy storage mode.
- c. Max. battery charge and discharge efficiency 97.8%.
- d. 2 strings of battery input with maximum 50A charge and discharge current.
- e. Wide battery voltage range(180-800V).
- f. Off-grid output can be connected to unbalanced load.
- g. AC Multi-parallel function, more flexible system solution.
- h. Smart monitoring, RS485/WiFi/Bluetooth/GPRS(Optional).

2.4. Electrical block diagram

Fig. 2-3 Electrical block diagram

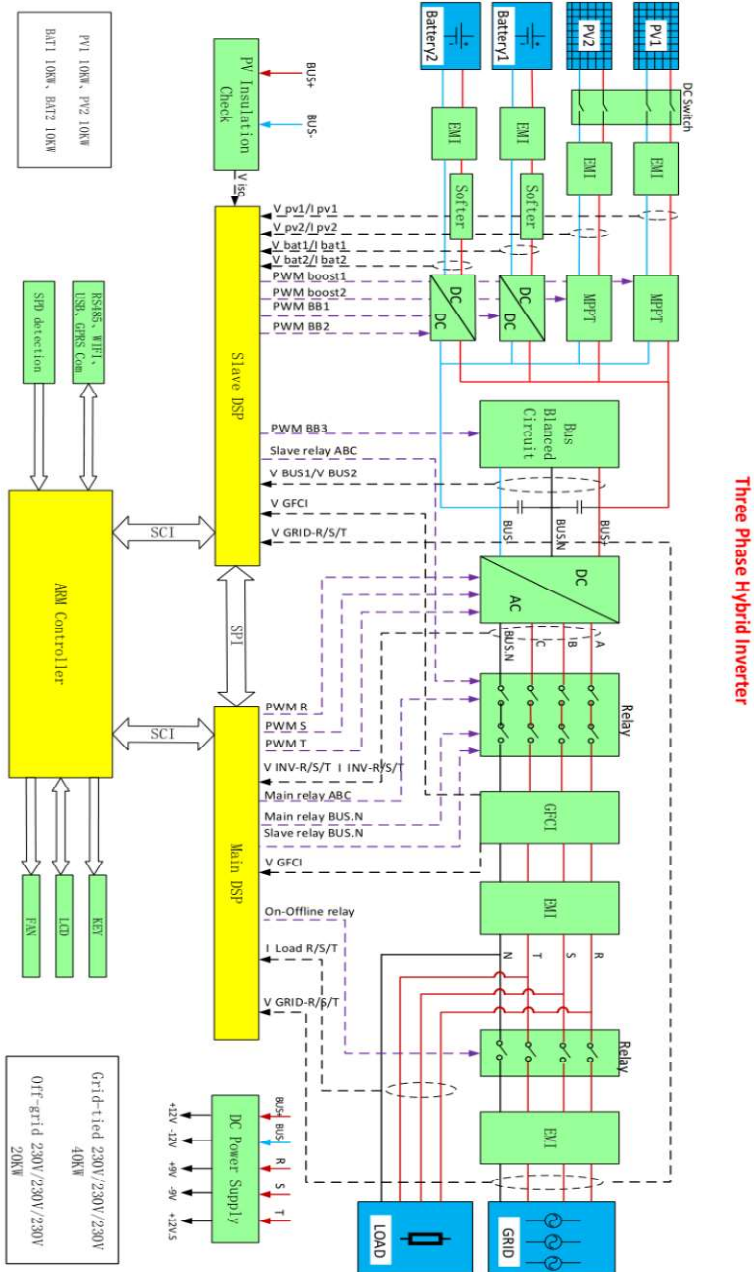

3. Application modes

3.1. Typical Energy Storage System

A typical energy storage system, when you first design the system, you have already included PV, battery and calculated the load capacity that needs to be sustained by the hybrid inverter. This is the whole system design.

Fig. 3-1 Typical Energy Storage System

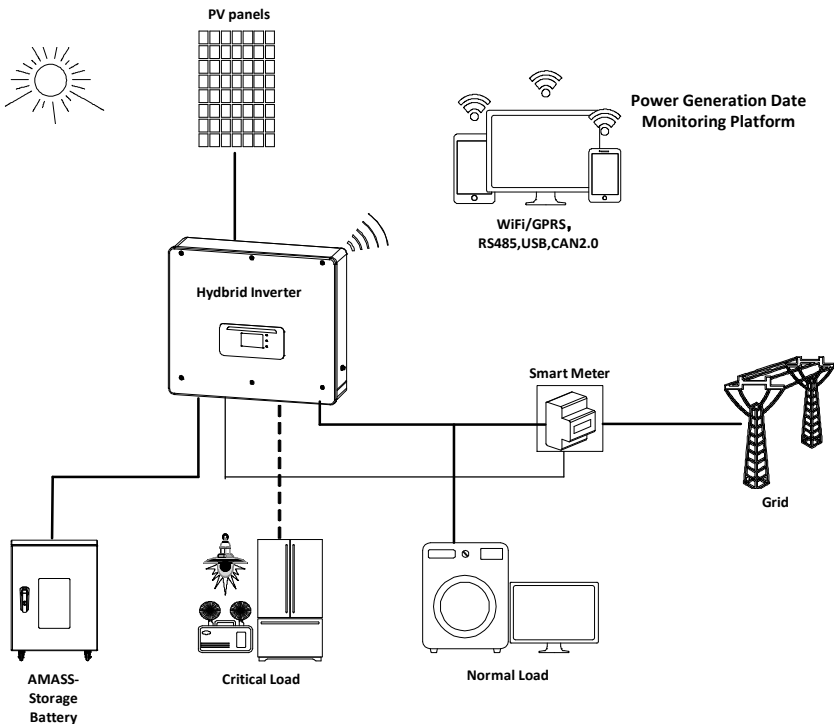

3.2. System Without PV Connection

- 1) There is no space to install the PV panel.
- 2) You don't want to install PV.
- 3) You want to install the PV later time.

This is the system configuration, and battery will be charged by the grid.

Fig. 3-2 System Without PV Connection

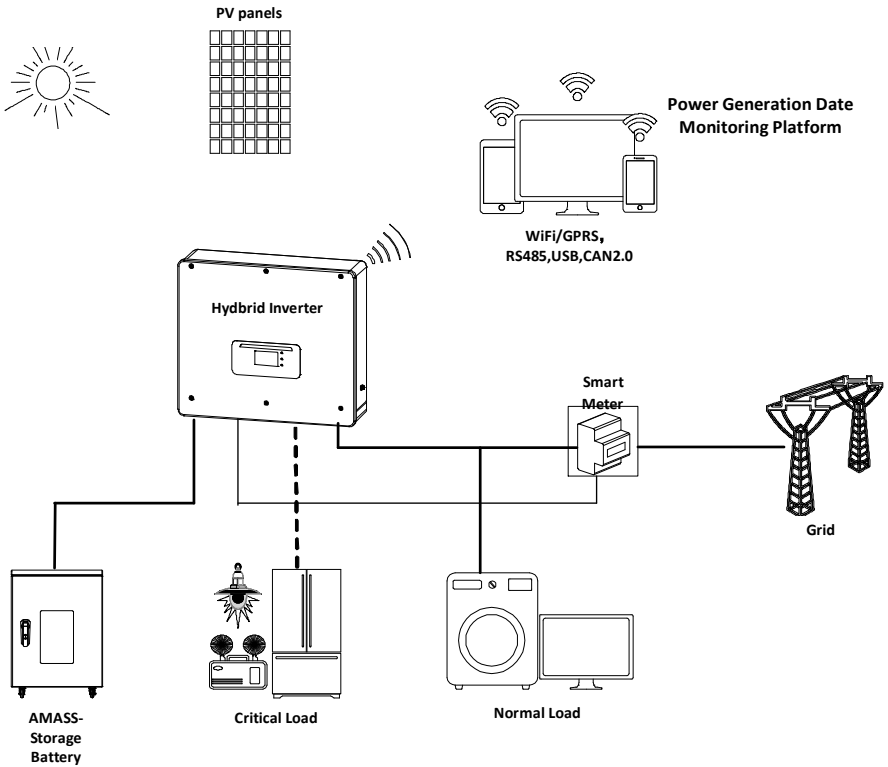

3.3. System Without Battery

- 1) You want just a grid-tied system.
- 2) You may add battery in the future.

This is the system configuration, battery function is always there, once you need, add it.

Fig. 3-3 System Without Battery

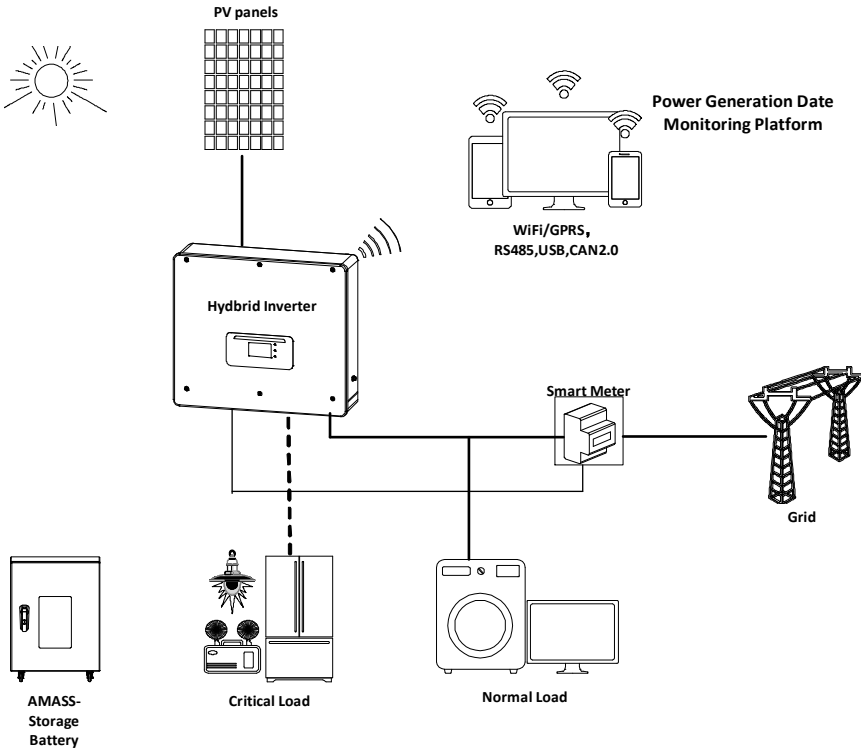

3.4. Back-up Mode (Without Grid)

- 1) The grid is down.
- 2) You don't want to use grid in peak hour.

This is the system configuration. If the PV is available, power will come from PV, or battery will sustain the critical load.

Fig. 3-4 Back-up Mode (Without Grid)

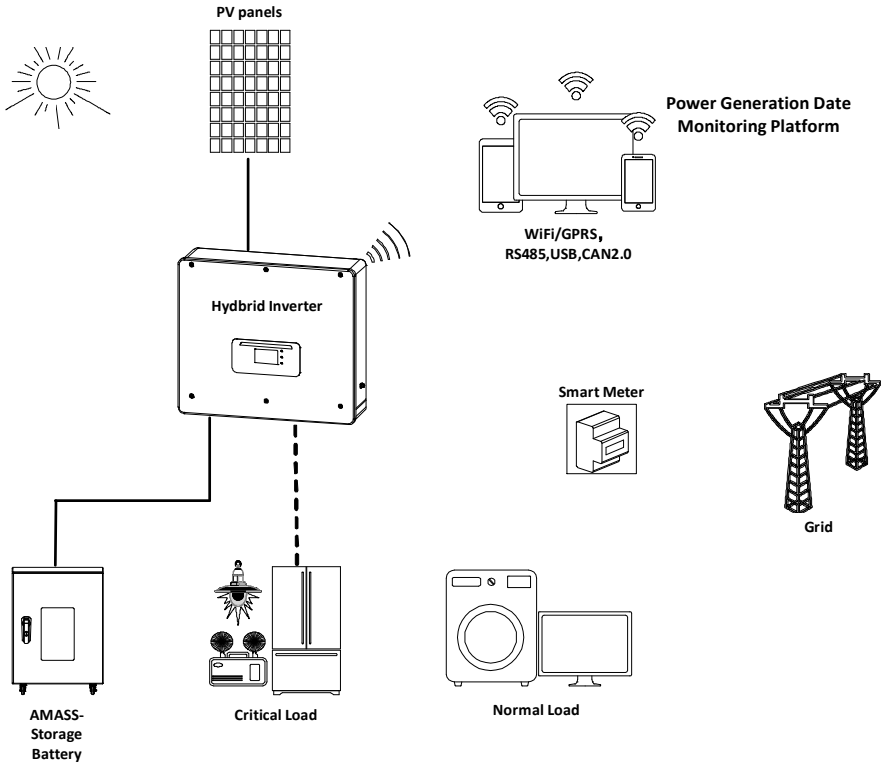

3.5. System With Multi Inverters

- 1) The system capacity is higher than 20kW.
- 2) PV panel is needed and enough space to install it.
- 3) Battery is needed for emergency or peak hour.

A parallel connection system for both AC output and Load output is the choice, maximum supports 10 units. So the system capacity will range from 5-200kW, which makes it possible for a lot application scenarios.

Fig. 3-5 System With Multi Inverters

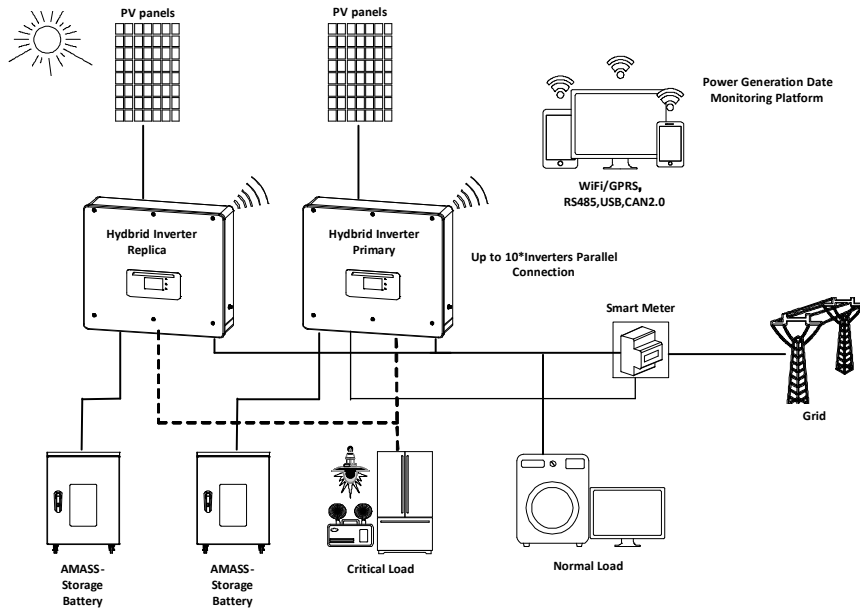

Note(AC LOAD is also parallel for parallel machines):

1. It is recommended that the AC LOAD output wiring of all machines should be combined together and connected to the LOAD by THE AC circuit breaker. It is not recommended that each machine should be connected to the AC circuit breaker separately to avoid the possibility that the power allocated to other machines will exceed the maximum allowable LOAD power of a single AC circuit breaker due to its disconnection.
2. It is recommended that AC GRID output wiring of all machines should be combined together and connected to the power GRID through AC circuit breaker. It is not recommended that each machine should be connected to AC circuit breaker

separately to the power GRID, because when the AC circuit breaker connected to a single machine is disconnected, the AC GRID end of this machine still has AC power, so as to avoid electric shock caused by operator's wrong judgment.

3. The cable length of the AC LOAD terminal connected from the LOAD terminal to each machine shall be consistent with the specification of the cable length, so as to ensure that the loop impedance is consistent and the current of the LOAD current diverted to each machine is nearly equal.

4. When the total power of AC Load is greater than 110% of the rated power of the machine (For example, one 20KW machine AC LOAD has a maximum allowable power of 22kVA and five parallel machines AC LOAD has a maximum allowable power of 110kVA), the Load should not be connected to AC Load and should be connected to AC Grid.

3.6. AC Retrofit System

- 1) Grid-tied solar system has already existed.
- 2) More capacity of power is needed.
- 3) Battery is needed for emergency.
- 4) Extra space for PV panel.

This is the solution can satisfy all the needs.

Fig. 3-6 AC Retrofit System(1)

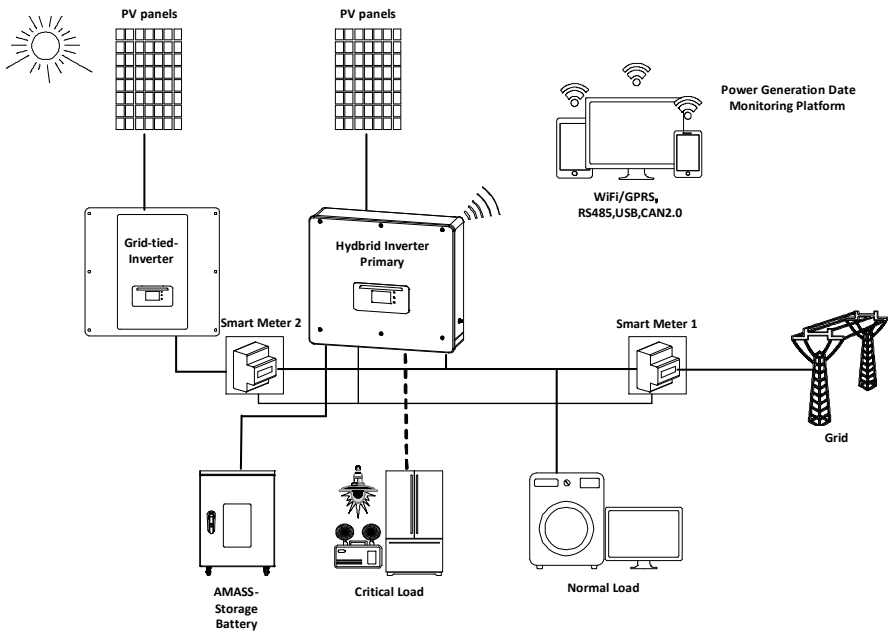

- 1) Grid-tied solar system has already existed.
- 2) More capacity of power is needed.
- 3) Battery is needed for emergency.
- 4) No extra space for PV panel.

This is the solution can satisfy all the needs.

Fig. 3-7 AC Retrofit System(2)

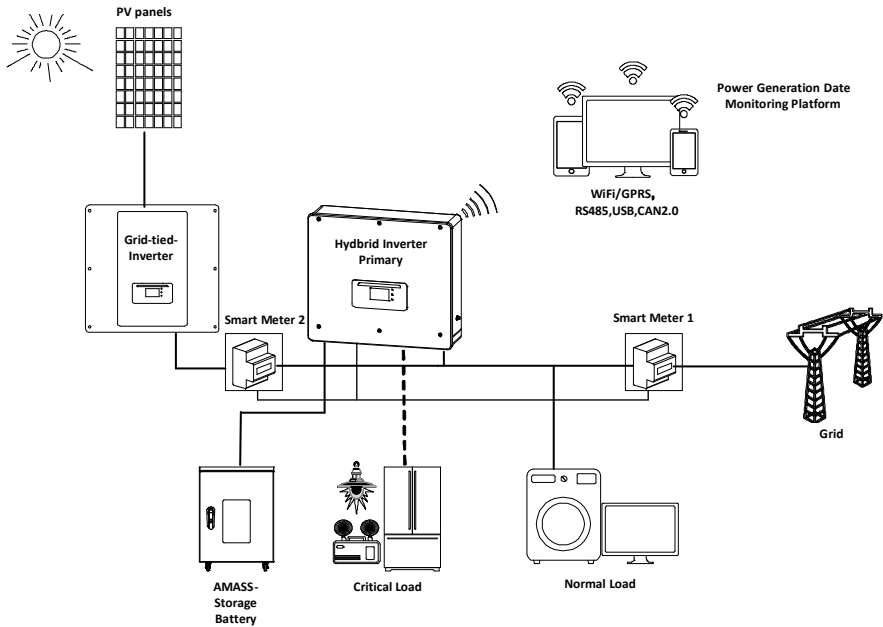

The communication address of Meter 1 should be set to 1. Similarly, the communication address of Meter 2 should be set to 2.

3.7. Back-up Unbalanced Output

- 1) The critical load is single phase.
- 2) The critical load of three phase are the same or unbalanced.

This is the best solution to satisfy your needs.

Fig. 3-8 Back-up Unbalanced Output

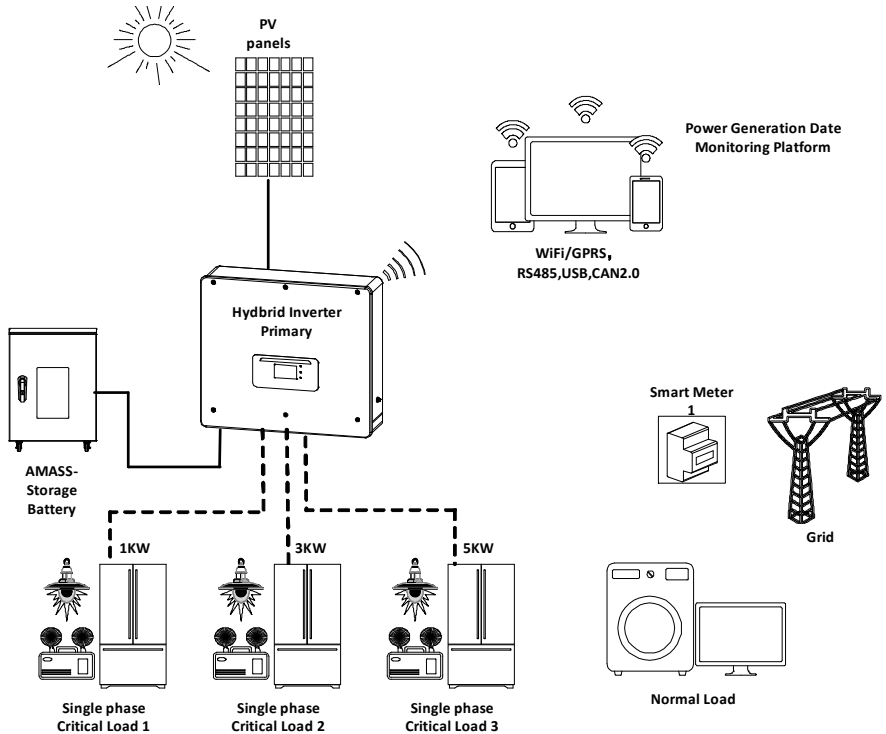

3.8. On-Grid Unbalanced Output

- 1) The normal load is single phase.
- 2) The normal load of three phase are the same or unbalanced.

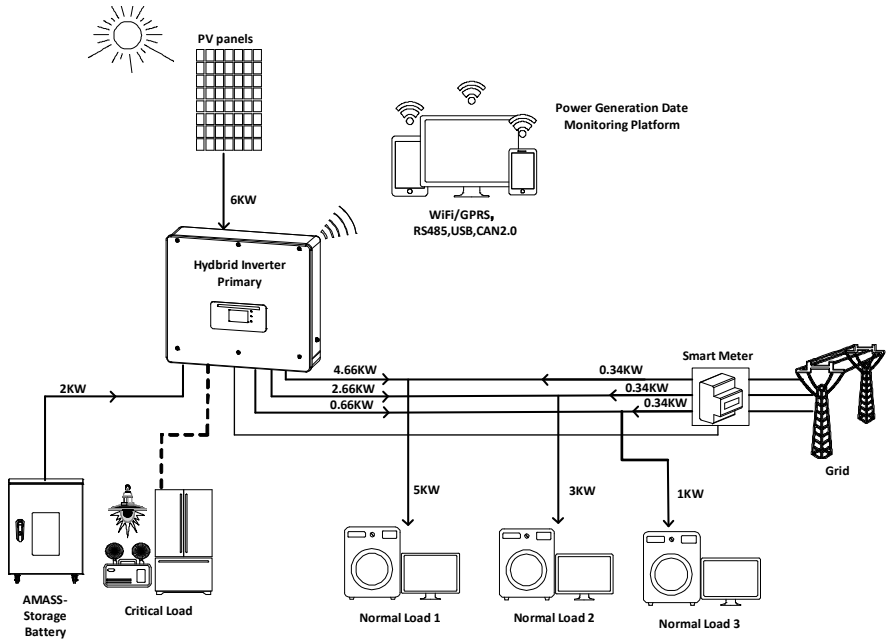

This is the best solution to satisfy your needs.

Fig. 3-9 On-Grid Unbalanced Output



4. Installation

Installation notes

	Do NOT install the HYD 5-20KTL-3PH on flammable material. Do NOT install the HYD 5-20KTL-3PH in an area used to store Flammable or explosive material.
Danger	
	The enclosure and heat sink are very hot while the inverter is working, therefore do NOT install the HYD 5-20KTL-3PH in places where you might touch them inadvertently.
Caution	
	Consider the weight of HYD 5-20KTL-3PH when transporting and moving the inverters. Choose an appropriate mounting position and surface. Assign at least two persons to install the inverter.
Attention	

4.1. Installation Process

Fig.4-1 Installation flowchart

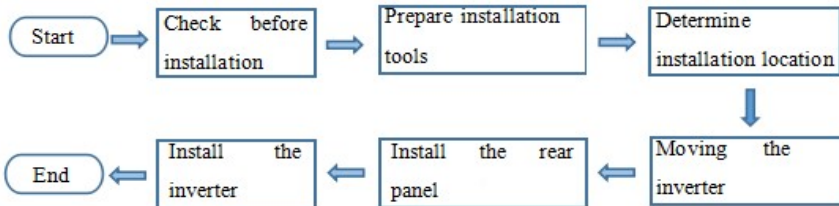

4.2. Checking Before Installation

Checking Outer Packing Materials

Packing materials and components may be damaged during transportation.











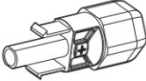
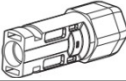

Therefore, check the outer packing materials before installing the inverter. Check the outer packing materials for damage, such as holes and cracks. If any damage is found, do not unpack the HYD 5-20KTL-3PH and contact the dealer as soon as possible. You are advised to remove the packing materials within 24 hours before installing the HYD 5-20KTL-3PH inverter.







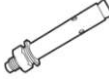

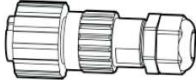

Checking Deliverables

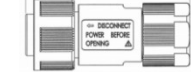
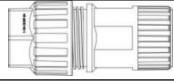
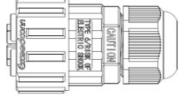
After unpacking the inverter, check whether deliverables are intact and complete. If

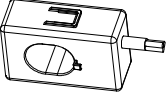
any damage is found or any component is missing, contact the dealer.

Table4-1 Components and mechanical parts that should be delivered

NO.	Picture	Description	Quantity
1		Inverter	1pcs
2		Rear panel	1pcs
3		PV+ input terminal	4pcs
4		PV- input terminal	4pcs
5		Metal terminals secured to PV+ input power cables	4pcs
6		Metal terminals secured to PV- input power cables	4pcs
7		BAT- input terminal	2pcs
8		BAT+ input terminal	2pcs
9		Metal terminals secured to BAT- input power cables	2pcs
10		Metal terminals secured to BAT+ input power cables	2pcs
11		M6 Hexagon screw	2pcs
12		M8*80 Expansion bolts used to secure the wall-mount bracket to the wall	4pcs
13		AC Grid connector	1pcs

14		AC Load connector	1pcs
15		Link port connector	1pcs
16		8 pin terminal Matching terminal resistance (parallel system)	1pcs
17		DRMs connector	1pcs
18		CT 6pin connector	1pcs
19		Three phase electronic energy meter	1pcs
20		Split Core Current Transformer AKH-0.66/K-Φ24 200A/5A (CT to be connected to the DTSU666 Meter only)	3pcs
21		COM 16pin connector	1pcs
22		Manual	1pcs
23		The warranty card	1pcs
24		Quality Certificate	1pcs
25		Outgoing inspection report	1pcs
26		M4X14 Cross round head triple set screw (Only for DC switch lock)	1pcs

27		NTC (5M)When using Inner BMS battery, must be connected to NTC	1pcs
----	--	--	------

4.3. Product Overview

HYD 5-20KTL-3PH inverter is 100% strictly inspected before package and delivery. It is forbidden to put the HYD 5-20KTL-3PH inverter upside down during delivery.

	Please check the product package and fittings carefully before installation.
Caution	

Fig.4-2 HYD 5-20KTL-3PH inverter overview

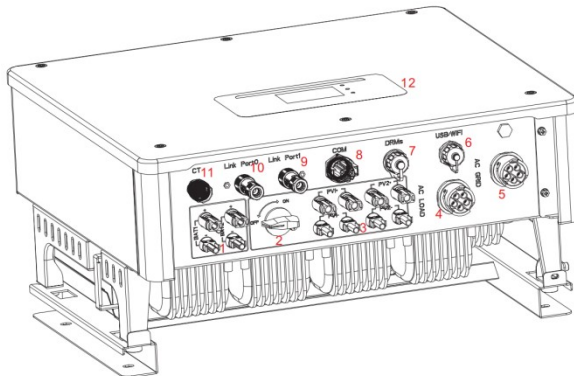

Table 4-2 HYD 5-20KTL-3PH inverter overview









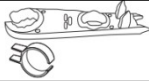
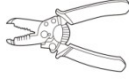

1	Battery input terminals	7	DRMs
2	DC switch	8	COM
3	PV input terminals	9	Link Port 1
4	Load connection port	10	Link Port 0
5	Grid connection port	11	CT
6	USB/WiFi	12	LCD

4.4. Tools

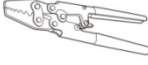
Prepare tools required for installation and electrical connections.

Table 4-3 Tools required for installation and electrical connections.

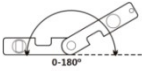
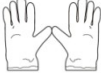
NO.	Tool	Model	Function
1		Hammer drill Recommend drill dia. 8mm	Used to drill holes on the wall.

2		Screwdriver	Wiring
3		Cross screwdriver	Remove and install AC terminal screws
4		Removal tool	Remove PV terminal
5		Wire stripper	Strip wire
6		6mm Allen Wrench	Turn the screw to connect rear panel with inverter.
7		Crimping tool	Used to crimp power cables
8		Multi-meter	Used to check grounding
9		Marker	Used to mark signs
10		Measuring tape	Used to measure distances
11		Level	Used to ensure that the rear panel is properly installed
12		ESD gloves	Operators wear
13		Safety goggles	Operators wear
14		Anti-dust respirator	Operators wear

4.5. Installation Environment

- a. Choose a dry, clean, and tidy place, convenient for installation.
- b. Ambient temperature range: $-25^{\circ}\text{C} \sim 60^{\circ}\text{C}$.
- c. Relative humidity: $0 \sim 100\%$ (non-condensed).
- d. HYD 5-20KTL-3PH inverter shall be installed in a well-ventilated place.
- e. No flammable or explosive materials close to HYD 5-20KTL-3PH inverter.
- f. Maximum altitude: 2000m.

g. Pollution degree: Four.

4.6. Determining the Installation Position

Determine an appropriate position for installing the HYD 5-20KTL-3PH inverter.

Comply with the following requirements when determining the installation position.

Fig. 4-3 Installation Position of HYD 5-20KTL-3PH inverter

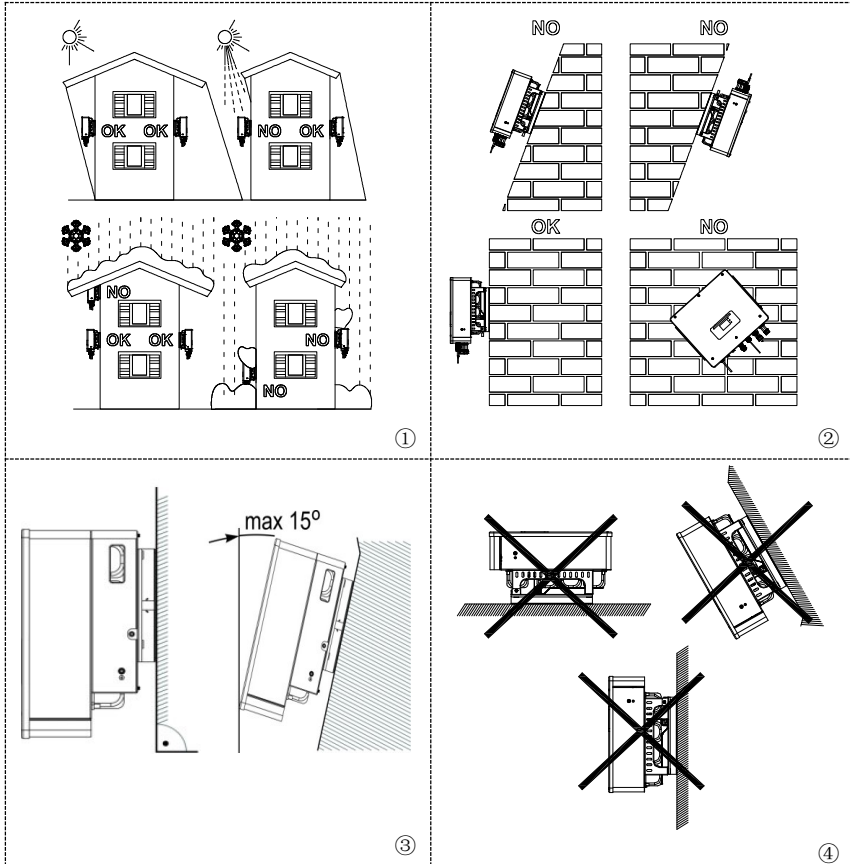

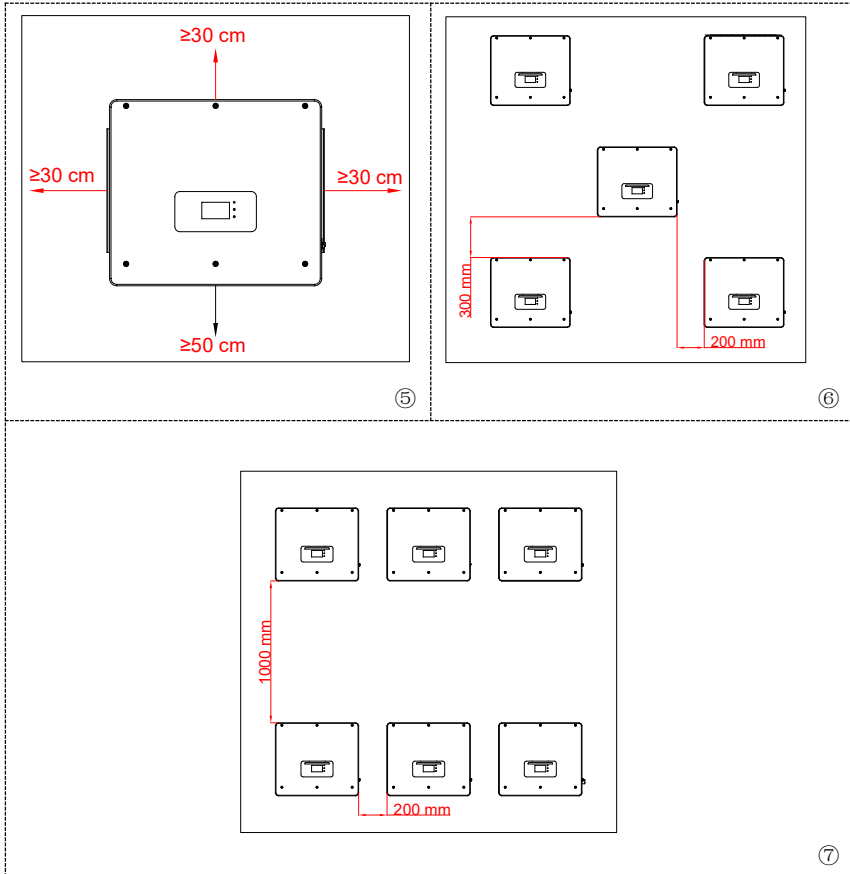



4.7. Moving the HYD 5-20KTL-3PH

Step 1 Open the packaging, insert hands into the slots on both sides of the inverter and hold the handles, as shown in Fig.4-4.

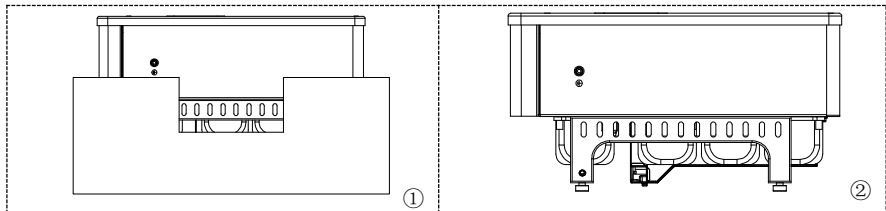
Fig. 4-4 Moving the inverter



Step 2 Lift the inverter from the packing case and move it to the installation position.

	<p>To prevent device damage and personal injury, keep balance when moving the inverter because the inverter is heavy. Do not put the inverter with its wiring terminals contacting the floor because the power ports and signal ports are not designed to support the weight of the inverter. Place the inverter horizontally.</p>
<p>Attention</p>	<p>When placing the inverter on the floor, put foam or paper under the inverter to protect its shell.</p>

4.8. Installing HYD 5-20KTL-3PH

Step 1 Determine the positions for drilling holes, ensure the hole positions are level, then mark the hole positions using a marker pen, use the hammer drill to drill holes on the wall. Keep the hammer drill perpendicular to the wall, do not shake when drilling, so as not to damage the wall. If the error of the hole positions is too big, you need to reposition.

Step 2 Insert the M8*80 expansion bolt vertically into the hole, pay attention to the insertion depth of the expanding bolt (should be deep enough).

Step 3 Align the rear panel with hole positions, fix the rear panel on the wall by tightening the expansion bolt with the nuts.

Step 4 Hook the inverter to the rear panel. Using an M6 hexagon screw to secure the inverter to the rear panel to ensure safety.

Step 5 You can secure the inverter to the rear panel and protect from stealing by installing an anti-theft lock (this action is optional).

Fig. 4-5 Installing HYD 5-20KTL-3PH

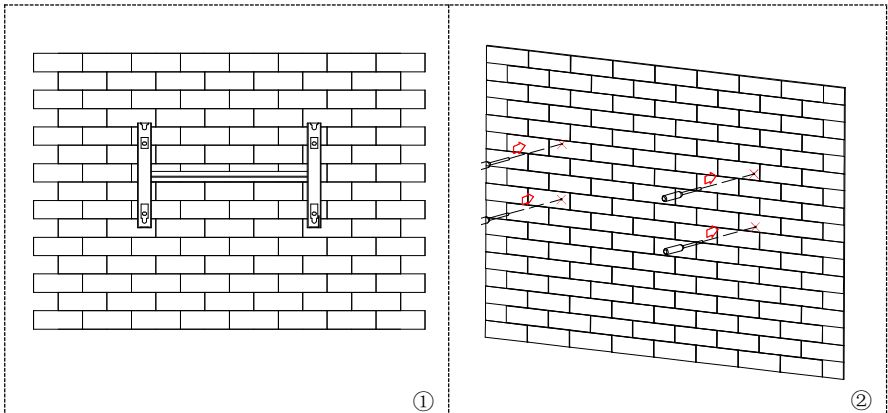

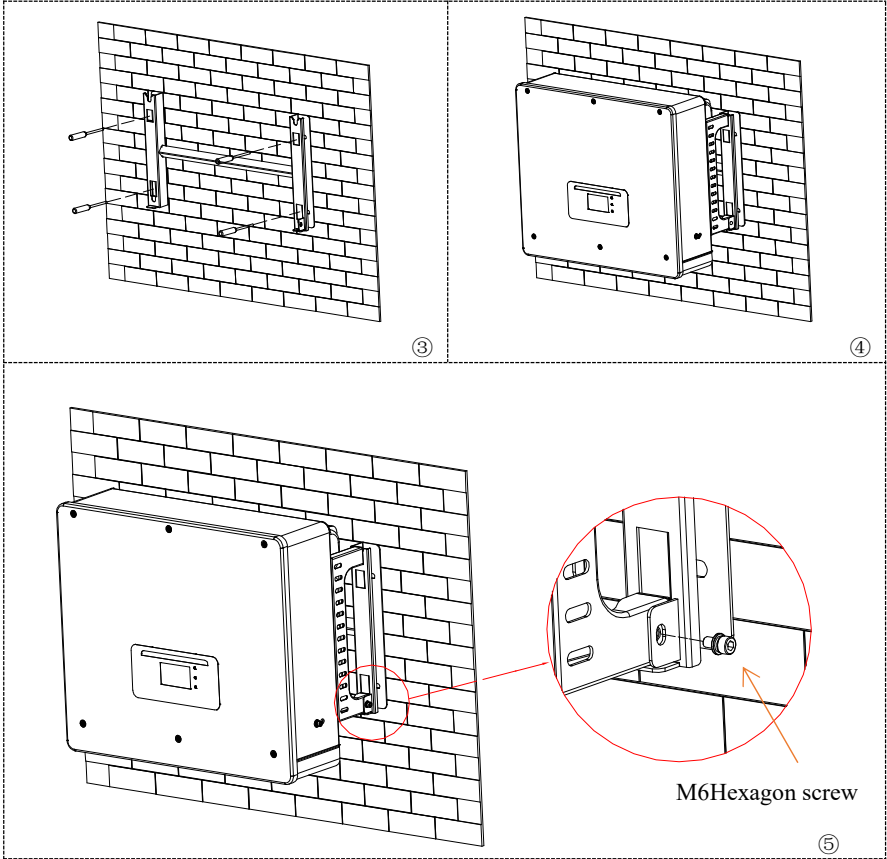



5. Electrical Connections

Before performing electrical connections, ensure that the DC switch is OFF. Since the stored electrical charge remains in a capacitor after the DC switch is turned OFF. So it's necessary to wait for at least 5 minutes for the capacitor to be electrically discharged.

HYD 5-20KTL-3PH inverter is intended to be used in PV system with battery storage. If not used as intended, the protection provided by the equipment may be impaired.

	Installation and maintenance of inverter, must be operated by professional electrical engineer. Wear rubber gloves and protective clothing (protective glasses and boots) when working on high voltage/high current systems such as inverter and battery systems.
Attention	
	PV modules generate electric energy when exposed to sunlight and can create an electrical shock hazard. Therefore, before connecting DC input power cable, cover PV modules using opaque cloth.
Danger	
	For HYD 5-20KTL-3PH, open-circuit voltage (Voc) of module arrays connected in series must be $\leq 1000V$.
Note	

The connected PV modules must have class A rating of IEC61730.

Table 5-1 Relevant current parameters of each model

Model	Isc PV(absolute maximum)	Maximum output over current protection
HYD 5KTL-3PH	15A/15A	8A*3
HYD 6KTL-3PH		10A*3
HYD 8KTL-3PH		13A*3
HYD 10KTL-3PH	30A/30A	16A*3
*HYD 10KTL-3PH-A		16A*3
HYD 15KTL-3PH		24A*3
HYD 20KTL-3PH		32A*3

Table 5-2 DC switch parameters

Rated-Insulation Voltage	1500V
Rated Impulse Withstand Voltage	8KV
Suitability For Isolation	Yes
Rated Operational Current (Ie)	1100V/40A,800V/55A
PV Utilization Category	DC-PV2
Rated Short Time Withstand Current (Icw)	0.76kA .1S
Rated Short-Circuit Making Capacity (Icm)	1.4kA
Rated Making Capacity/Rated Breaking Capacity	1.4kA

Table 5-3 PV terminal parameters

Rated-Insulation Voltage	1000V
Rated Operational Current	39A
Protection Class	IP68
Maximum Temperature Limit	105°C

Table 5-4 The decisive voltage class(DVC)

Interface	DVC
PV input port	DVCC
Grid connection port	DVCC
Battery input port	DVCC
Load connection port	DVCC
USB/WiFi interface	DVCA
COM interface	DVCA
CT interface	DVCA
DRMs	DVCA
Link Port 0 &Link Port 1	DVCA

NOTE: The DVC is the voltage of a circuit which occurs continuously between any two live part in the worst-case rated operating condition when used as intended.

5.1. Wire instructions

Table 5-5 Cable description

Component	Description	Recommended cable type	Recommended cable specifications	
	+: Connect the positive electrode of lithium battery	Outdoor multi-core copper cable	Conductor cross-sectional area: 4mm ² ~6mm ²	
	-: Connect the negative electrode of lithium battery			
	+: Connect the positive electrode of photovoltaic cell	Industry common outdoor photovoltaic cable	Conductor cross-sectional area: 4mm ² ~6mm ²	
	-: Connect the negative electrode of photovoltaic cell			
	+: Connect the positive electrode of photovoltaic cell	Industry common outdoor photovoltaic cable	Conductor cross-sectional area: 4mm ² ~6mm ²	
	-: Connect the negative electrode of photovoltaic cell			
	Load	L1	Outdoor multi-core copper cable	Conductor cross-sectional area: 6mm ² ~10mm ²
		L2		
		L3		
		N		
		PE		
	AC	L1	Outdoor multi-core copper cable	Conductor cross-sectional area: 10mm ² ~16mm ²
		L2		
		L3		
		N		
		PE		

Here L1, L2 and L3 correspond to R, S and T in the manual.

5.2. Connecting PGND Cables

Connect the inverter to the grounding electrode using protection ground (PGND) cables for grounding purpose.



Attention

The inverter is transformer-less, requires the positive pole and negative pole of the PV array are NOT grounded. Otherwise it will cause inverter failure. In the PV power system, all non current carrying metal parts (such as: PV module frame, PV rack, combiner box enclosure, inverter enclosure) should be connected to earth.

The PGND cables are prepared ($\geq 4\text{mm}^2$ outdoor power cables are recommended)

for grounding purposes),the color of cable should be yellow-green.

Procedure:

Step 1 Remove the insulation layer with an appropriate length using a wire stripper, as shown in Fig.5-1.

Step 2 Insert the exposed core wires into the OT terminal and crimp them by using a crimping tool, as shown in Fig.5-1.

Step 3 Install the crimped OT terminal, flat washer using M6 hexagon screw, and tighten the screw to a torque of 3N.m using an Allen wrench.

Note 1: L3 is the length between the insulation layer of the ground cable and the crimped part.L4 is the distance between the crimped part and core wires protruding from the crimped part.

Note 2: The cavity formed after crimping the conductor crimp strip shall wrap the core wires completely. The core wires shall contact the terminal closely.

Fig.5-1 Connecting PGND cable

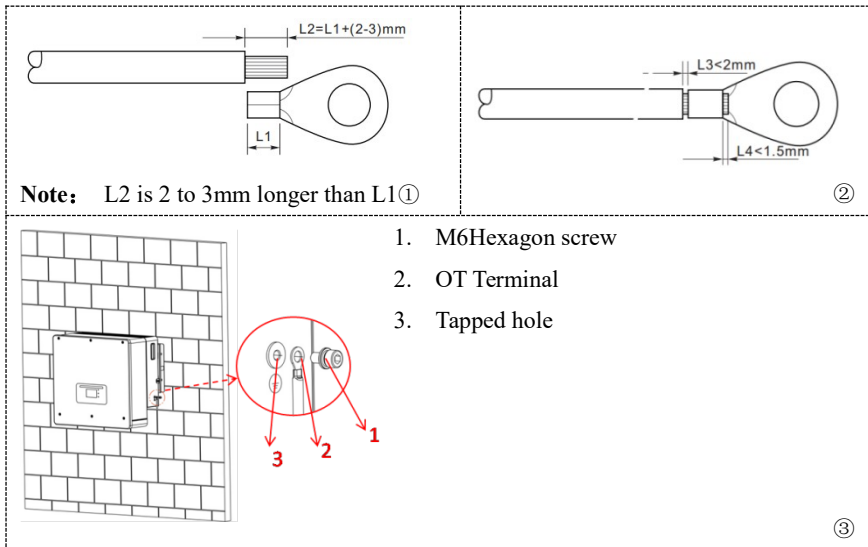

5.3. Battery Connection & PV Connection

The connection mode of Battery connection and PV connection is the same, only the terminal specifications are different. The color of Battery terminal is blue, and the color of PV terminal is black. Please correctly correspond when inserting the terminal into the machine end.

Procedure:

Step 1 Select the appropriate cable type and specifications according to the table5-3.Remove cable glands from the positive and negative connectors.(It is recommended that the positive and negative be distinguished by different colors).

Step 2 Remove the insulation layer with an appropriate length from the positive and negative power cables by using a wire stripper as show in Fig.5-2①.

Step 3 Insert the stripped positive and negative power cables into the positive and negative metal terminals respectively and crimp them using a clamping tool.

Ensure that the cables are crimped until they cannot be pulled out by force less than 400 N, as shown in Fig.5-2②③.

Step 4 Insert crimped power cables into corresponding housings until you hear a "click" sound. The power cables snap into place.

Step 5 Reinstall cable glands on positive and negative connectors and rotate them against the insulation covers.

Step 6 Insert the positive and negative connectors into corresponding Battery &PV terminals of the inverter until you hear a "click" sound, as shown in Fig.5-2④.

To remove the positive and negative connectors from the inverter, insert a removal wrench into the bayonet and press the wrench with an appropriate strength, as shown in Fig.5-2⑦.



Before removing the positive and negative connectors, ensure that the DC SWITCH is OFF.

Fig.5-2 Connect Battery& PV

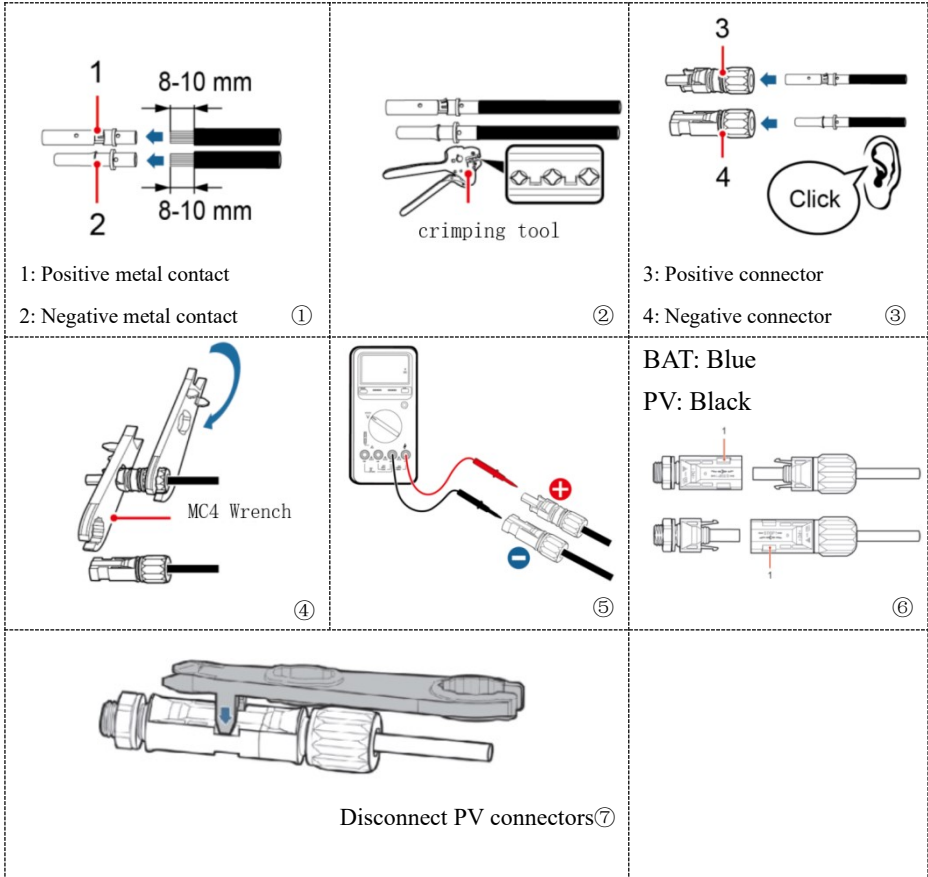

5.4. AC Load connection

Please find the correct AC Load terminal according to the terminal accessory label.

Procedure:

Step1 Select the appropriate cable type and specifications according to the table5-3.Refer to Fig.5-3① for processing wire.

Step 2 Pass the wire through the terminal, as shown in Fig.5-3②.

Step 3 Connect the wire to the terminal according to the identification on the terminal, as shown in Fig.5-3③④.

Step 4 Connect the terminal to the machine port and rotate the clamp clockwise.

Fig.5-3 AC Load connection

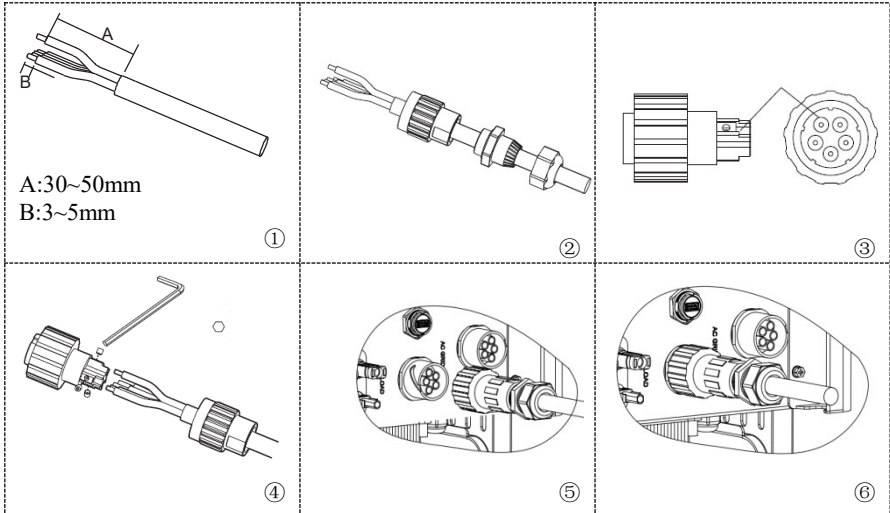

5.5. AC Grid connection

Please find the correct AC Grid terminal according to the terminal accessory label.

Procedure:

Step1 Select the appropriate cable type and specifications according to the table5-3.Refer to Fig.5-4① for processing wire.

Step 2 Pass the wire through the terminal, as shown in Fig.5-4②.

Step 3 Connect the wire to the terminal according to the identification on the terminal, as shown in Fig.5-4③④.

Step 4 Connect the terminal to the machine port and rotate the clamp clockwise.

Fig.5-4 AC Grid connection

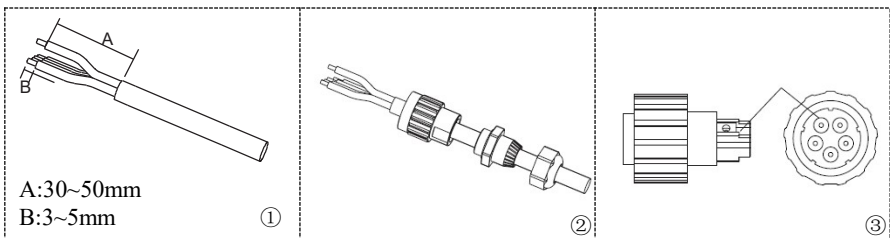

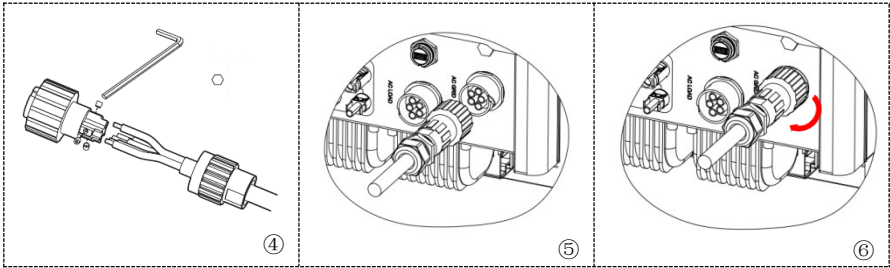

5.6. External communication interface

5.6.1 USB/WIFI communication interface

Fig.5-5 USB/WIFI communication interface

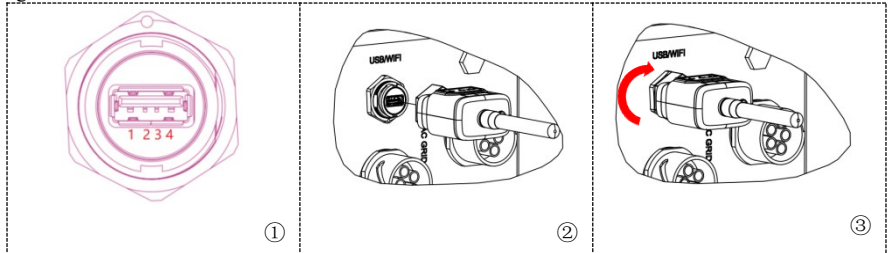
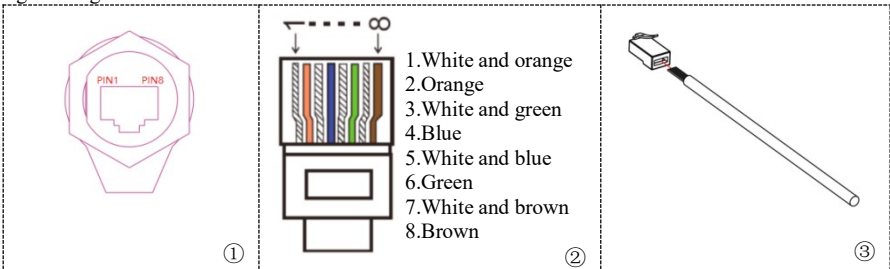

Table5-6 Interface description

USB communication interface	USB: USB flash disk access	Used for inverter firmware upgrade and data recording
	WIFI: WIFI data collector access	Used to connect WiFi data collector

5.6.2 DRMs interface- Logic interface

Fig.5-6 Logic interface



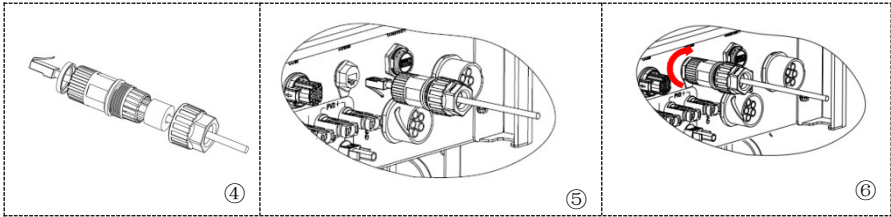

Procedure:

Step 1 Press the wire terminals in color sequence.

Step 2 Route Cable terminal through the cable gland, Insert the communication cable into the RJ45 connector.

The logic interface pin definitions and circuit connections are as follows:

Logic interface pin are defined according to different standard requirements

(a) Logic interface for AS/NZS 4777.2:2020, also known as inverter demand response modes (DRMs).

The inverter will detect and initiate a response to all supported demand response commands within 2 s. The inverter will continue to respond while the mode remains asserted.

Table 5-7 Function description of the DRMs terminal

Pin NO.	Color	Function
1	White and orange	DRM1/5
2	Orange	DRM2/6
3	White and green	DRM3/7
4	Blue	DRM4/8
5	White and blue	DRM0
6	Green	RefGen
7	White and brown	Pin7&Pin8 short internal
8	Brown	

Table 5-8 Demand response modes (DRMs)

Demand response mode	Real current limit (referenced to inverter rated per phase current)	Reactive current limit (referenced to inverter rated per phase current)	Switching time limit
DRM 0	0	0	2 s
DRM 1	Import = 0	0	2 s
DRM 2	Import < 50%	As per Clauses 5.5, 6.2 and DRM 3 and DRM 7	2 s
DRM 3	Import < 75%	Within 5% of set-point per Clause 6.2	2 s
DRM 4	Not limited	As per Clauses 5.5, 6.2 and DRM 3 and DRM 7	2 s
DRM 5	Generate = 0	0	2 s
DRM 6	Generate < 50%	As per Clauses 5.5, 6.2 and DRM 3 and DRM 7	2 s
DRM 7	Generate < 75%	Within 5% of set-point per Clause 6.2	2 s
DRM 8	Not limited	As per Clauses 5.5, 6.2 and DRM 3 and DRM 7	2 s

NOTE: For DRM 0, DRM 1 and DRM 5, current draw due to sensing and DRED circuits is allowable (see Clause 7.2).

(b) Logic interface for VDE-AR-N 4105:2018-11, is in order to control and/or limit the inverter's output power.

The inverter can be connected to a RRCR (Radio Ripple Control Receiver) in order to dynamically limit the output power of all the inverters in the installation.

Fig.5-7 Inverter – RRCR Connection

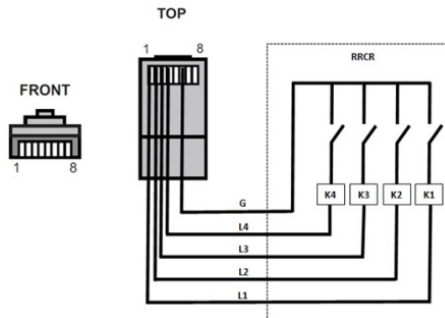

Table 5-9 Function description of the terminal

Pin NO.	Pin name	Description	Connected to (RRCR)
1	L1	Relay contact 1 input	K1 - Relay 1 output
2	L2	Relay contact 2 input	K2 - Relay 2 output
3	L3	Relay contact 3 input	K3 - Relay 3 output
4	L4	Relay contact 4 input	K4 - Relay 4 output
5	NC	Not Connected	Not Connected
6	G	GND	Relays common node

7	NC	Not Connected	Not Connected
8	NC	Not Connected	Not Connected

Table 5-10 The inverter is preconfigured to the following RRCR power levels,close is 1, open is 0

L1	L2	L3	L4	Active Power	Cos(φ)
1	0	0	0	0%	1
0	1	0	0	30%	1
0	0	1	0	60%	1
0	0	0	1	100%	1

(c) Logic interface for EN50549-1:2019, is in order to cease active power output within five seconds following an instruction being received at the input interface.

Fig.5-8 Inverter – RRCR Connection

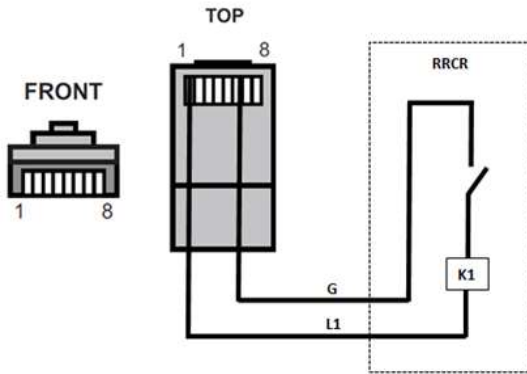

Table 5-11 Function description of the terminal

Pin NO.	Pin name	Description	Connected to (RRCR)
1	L1	Relay contact 1 input	K1 - Relay 1 output
2	NC	Not Connected	Not Connected
3	NC	Not Connected	Not Connected
4	NC	Not Connected	Not Connected
5	NC	Not Connected	Not Connected
6	G	GND	K1 - Relay 1 output
7	NC	Not Connected	Not Connected
8	NC	Not Connected	Not Connected

Table 5-12 The inverter is preconfigured to the following RRCR power levels,close is 1, open is 0

L1	Active Power	Power drop rate	Cos(φ)
1	0%	<5 seconds	1
0	100%	/	1

5.6.3 COM-Multifunction communication interface

Fig.5-8 COM interface

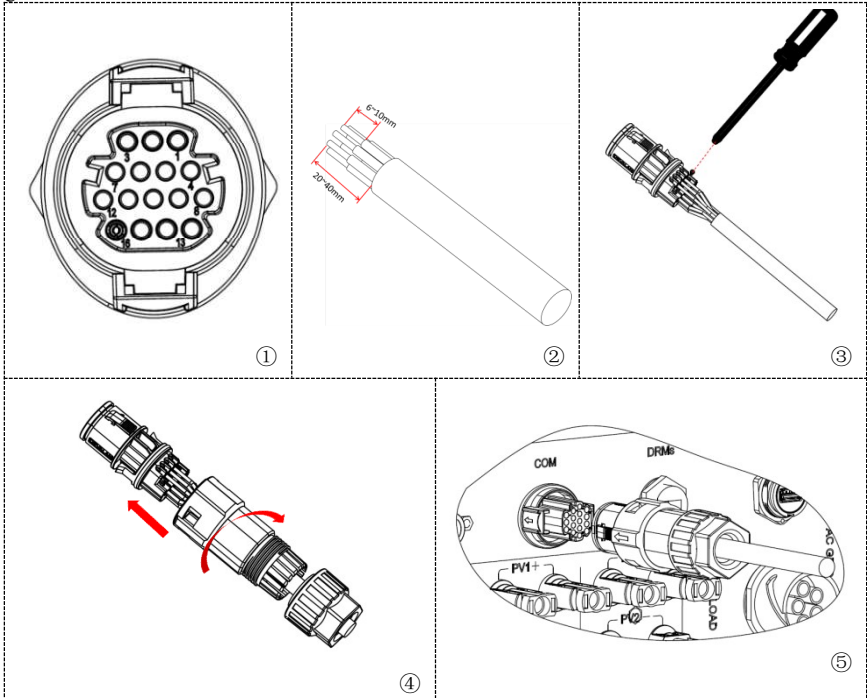

Please refer to the following figure for RS485 connection When you need to use RS485 as a cascade of monitoring between inverters.

Fig.5-9 RS485 connection(cascade of monitoring between inverters)

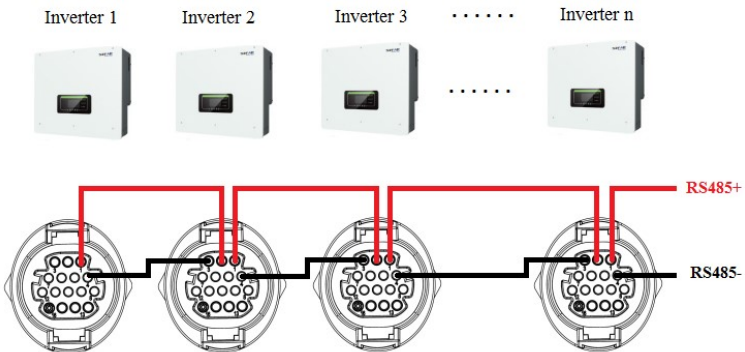

Table 5-13 Interface description

PIN	Definition	Function	Note
1	RS485A1-1	RS485differential signal+	Wired monitoring or inverter cascade monitoring
2	RS485A1-2	RS485differential signal+	
3	RS485B1-1	RS485differential signal-	
4	RS485B1-2	RS485differential signal-	
5	RS485A2	RS485differential signal+	Communicate with electricity meters
6	RS485B2	RS485differential signal-	
7	CAN0_H	CAN high data	Used for communication with lithium battery BMS, the inverter can automatically identify the battery BMS communication as CAN or RS485 communication
8	CAN0_L	CAN low data	
9	GND.S	BMS communication GND	
10	485TX0+	RS485differential signal+	
11	485TX0-	RS485differential signal-	Inner BMS battery temperature sampling
12	GND.S	Signal GND	
13	BAT_Temp	Battery temperature sampling	Providing electrical switching function
14	DCT1	Dry Contact1	
15	DCT2	Dry Contact2	12V power supply
16	VCC	Communication VCC	

PIN5 and PIN6 are used for meter communication, the electricity meter is shown in the Fig.5-10①, PIN5 and PIN6 correspond to 24,25 respectively on the electricity meter, as shown in Fig.5-10③.

The connection mode is shown in Fig.5-10②. The 2,5,8 and 10 on the electricity meter are connected to voltage signals A,B,C and N respectively.

And the current needs to be connected through the current transformer, On the meter, 1 and 3 are connected to the positive (red) lead and negative (black) lead of the A-phase current transformer. Similarly, 4 and 6 are connected to the B-phase current transformer, and 7 and 9 are connected to the c-phase current transformer.

NOTE: The direction of the current transformer is shown in Fig.5-10④.

Fig.5-10 Meter

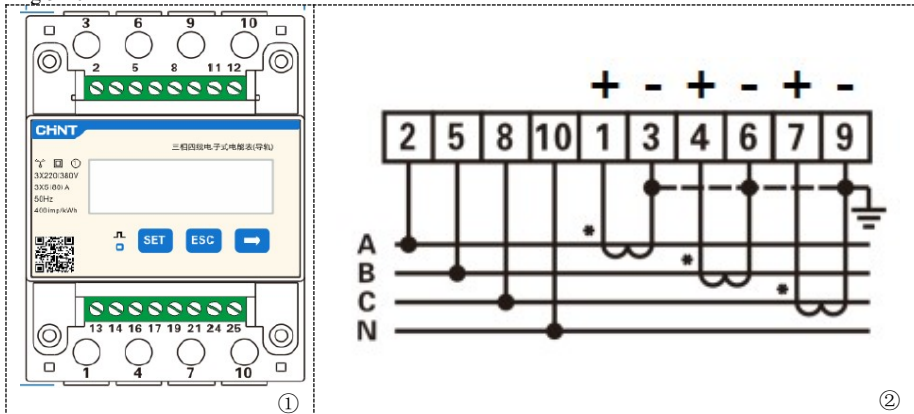

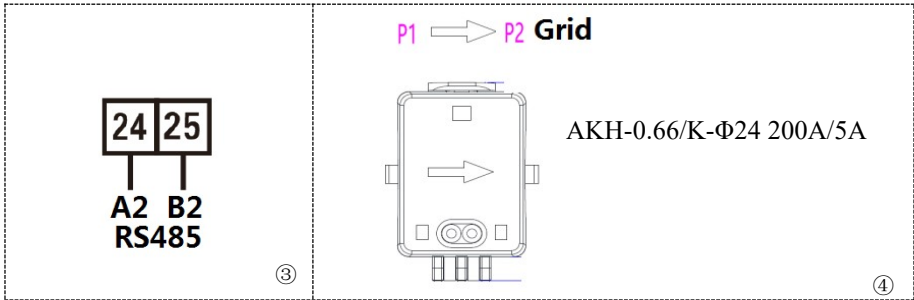

PIN7~PIN11 are used for communication with lithium battery BMS, the inverter can automatically identify the battery BMS communication as CAN or RS485 communication.

Fig.5-11 For lithium battery BMS using CAN communication

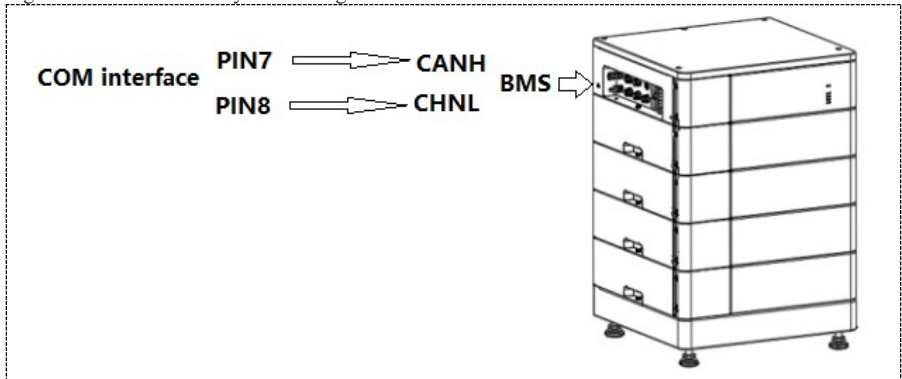
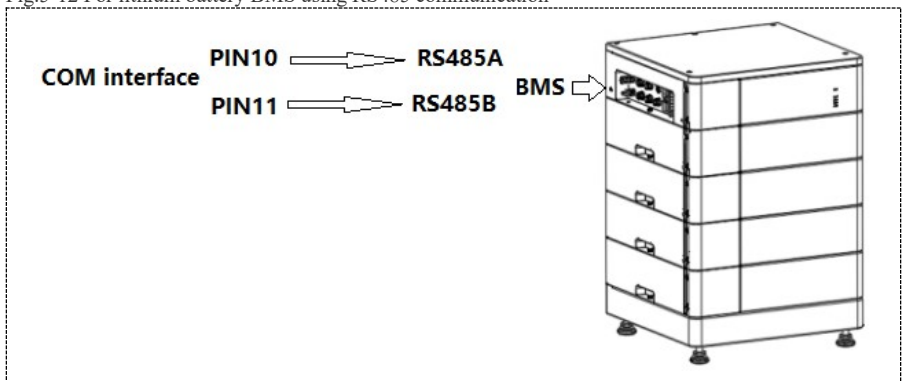

Fig.5-12 For lithium battery BMS using RS485 communication



When the battery is a Inner BMS battery, the battery NTC temperature sensor must be connected to the COM interface of the inverter. The two leads of the battery NTC temperature sensor have no polarity and do not need to be distinguished. Connect them to PIN12 and PIN13 of the COM interface respectively.

The other end of the battery NTC temperature sensor is locked to the periphery of the battery pack.

Fig.5-13 battery NTC temperature sensor

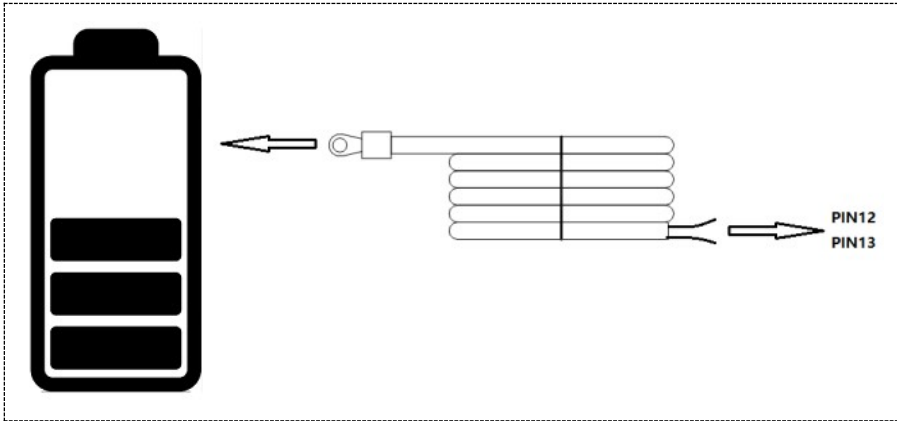

5.6.4 Link Port 0&1-Cascade communication interface

Fig.5-14 Link Port

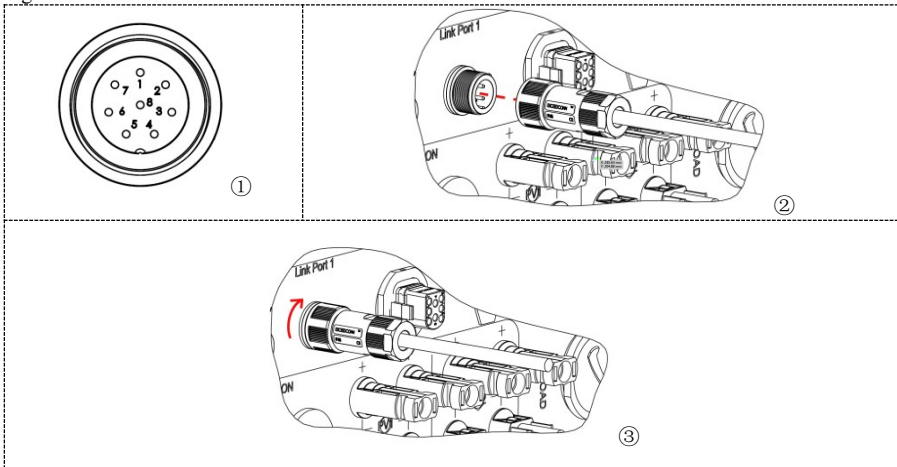

When using the parallel system, the inverter settings and notes please refer to this

manual<7.3.2 Advanced setting→7.Parallel setting>.

NOTE:

- 1.The first and last inverters need to be connected to the 8Pin terminal.
- 2.The working state of all machines in the parallel machine system must be consistent.
- 3.The main AC switch must be turned off during machine maintenance.

Fig.5-15 parallel system

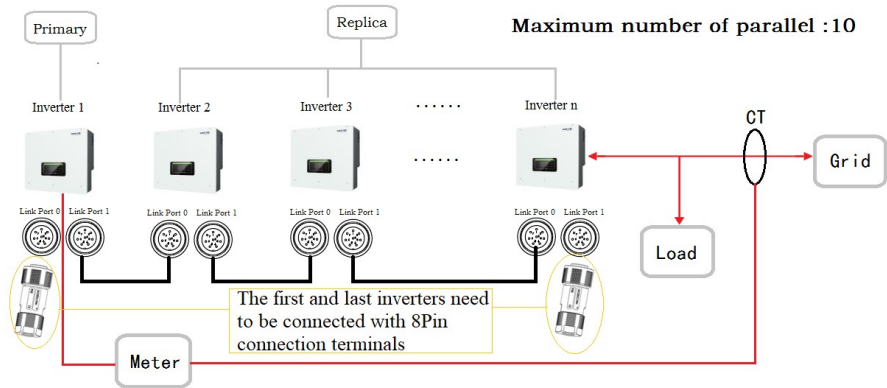

Table 5-14 Interface description

PIN	Definition	Function	Note
1	IN SYN0	Synchronizing signal0	The high level of the synchronous signal is 12V
2	CANL	CAN low data	
3	SYN_GND0	Synchronizing signal GND0	
4	CANH	CAN high data	
5	IN SYN1	Synchronizing signal1	
6	SYN_GND1	Synchronizing signal GND1	
7	SYN_GND2	Synchronizing signal GND2	
8	IN SYN2	Synchronizing signal2	

5.6.5 CT-External current sensor interface

Table 5-15 Interface description

PIN	Definition	Function	Note
1	Ict_R-	The current sensor outputs a negative electrode	Used to connect R phase current sensor of power grid
2	Ict_R+	The current sensor outputs a positive electrode	
3	Ict_S-	The current sensor outputs a negative electrode	Used to connect S phase current sensor of power grid

4	Ict_S+	The current sensor outputs a positive electrode	Used to connect T phase current sensor of power grid
5	Ict_T-	The current sensor outputs a negative electrode	
6	Ict_T+	The current sensor outputs a positive electrode	

Fig.5-16 CT interface

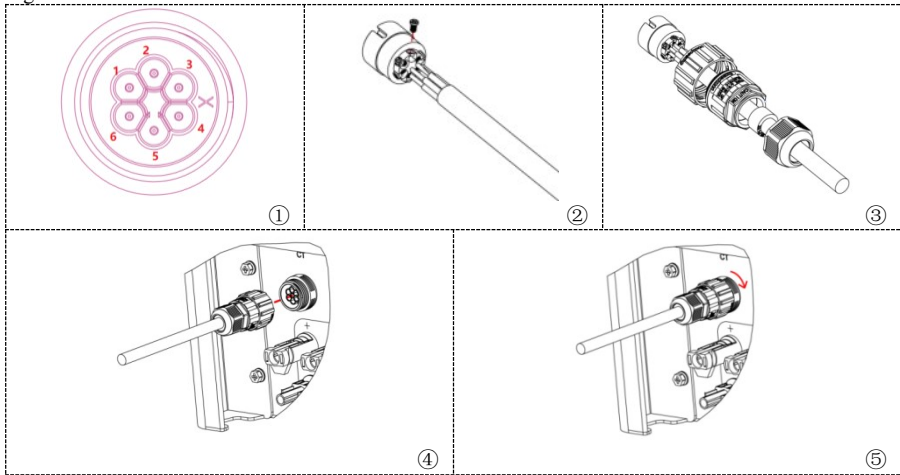

Generation and Export Limit Control functions for the inverter are available but require the use of an external measurement device to obtain grid information.

There are 2 ways to obtain grid information:

- Plan A: CT (optional)
- Plan B: Meter + CT (default)

Systems with less than 300A per phase can use either Plan A or Plan B. When the current per phase exceeds 300A and above, only Plan B can be used.

The default CT in the inverter packing case is used with an electricity meter. If plan A is needed, please purchase it by yourself or contact the SOFARSOLAR technical support personnel.

The model parameters of the meter and CT used in Plan B are as follows.

Customers can choose CT of different specifications according to the actual situation, and it can be matched by modifying the current transformation ratio on the meter, but the secondary rated current of the CT must be 5A.

Meter: DTSU666

Voltage	AC 3×230/400V
Current	1.5(6)A
Frequency	(50/60)Hz
Pulse	6400imp/kwh
Power accuracy	Active Class 0.5S,Reactive Class 2

CT: AKH-0.66/K- Φ24 200A/5A

Rated primary current	200A
Rated secondary current	5A
voltage classes	0.66kV
Rated working frequency	50/60Hz
Precision	1.0%
Primary punch size	Φ 24mm

To obtain grid information via Plan A:

Connect the wires according to the wiring method as shown in “Figure 5-17 Plan A”, and enable Anti-Reflux Power function and set the Reflux Power limit on the menu interface of the machine. Refer to <7.4.2 Advanced setting→3. Anti Reflux> in this manual for specific operation methods.

There are two situations when CT is installed. One is to connect in the correct CT direction. The direction should refer to the figure below, from the inverter to the power grid. One is the random CT direction, and then the use of CT calibration function for calibration. CT calibration procedures refer to this manual 7.4.2>>9.CT calibration.

To obtain grid information via Plan B:

Wiring according to the wiring method as shown in "Figure 5-18 Plan B", and

enable Anti-Reflux Power function and set the Reflux Power limit on the menu interface of the machine. Refer to <7.4.2 Advanced setting→3. Anti Reflux> in this manual for specific operation methods.

Only installers and distributors have the permission to use the Bluetooth APP for setting, enabling/disabling settings, and setting up the Reflux Power limit. Refer to <7.4.2 Advanced setting→3. Anti Reflux> in this manual for specific operation methods.

Please Note:

Generation and Export Limit Control functions are set as follows:

User can set and check through LCD menu. Refer to <7.4.2 Advanced setting→3. Anti Reflux> and <7.4.4 System information→1. Inverter Info> .

Settings Main interface---Advanced Setting---Input 0001---Anti Reflux---Anti Reflux Mode---Control Mode---Control Type---Power limit .

Main interface	Back	1.System Setting	
		2.Advanced Setting	
		3.Energy Statistic	
		4.System Information	
		5.Event List	
		6.Software Update	
2.Advanced setting	OK	Input 0001	
		1.Battery Parameter	
		2.Battery Active	
		3.Anti Reflux	
		...	
3.Anti Reflux	OK	1.Anti Reflux Mode	OK
			Disable
			Anti Reflux
			Three phase limit
		2.Control Mode	OK
			Generation limit
			Export limit
		3.Control Type	OK
			Soft limit
			Hard limit
			Both
		4.Power limit	***KW(VA)

Checking Main interface---System Information---Inverter Info---Anti Reflux.

Main interface	Back	1.System Setting
		2.Advanced Setting
		3.Energy Statistic
		4.System Information
		5.Event List
		6.Software Update
4.System information	OK	1.Inverter Info
		2.Battery Info
		3.Safety Param.
1.Inverter Info	OK	Inverter Info (1)
	Down↓
	Down↓	Inverter Info (6)
		Anti Reflux (enable or disable)

Anti-Reflux Power function =Generation or Export Limit Control function
 Generation (or Export) limit =Generation (or Export) limit control
 Reflux Power limit = (active or apparent) Power limit

When Anti-Reflux Power function is enabled, the reflux power of point of common coupling (PCC) will be limited to the set Reflux Power limit. Both Hard limit control and Soft limit control can be used together. However, when Hard limit control is enabled, Anti-Reflux power cannot exceed the Reflux power limit. If the Reflux power exceeds the Reflux power limit, the inverter disconnects from the grid and triggers overload protection.

When communication signal with the electricity meter is lost, the output power of the inverter is limited to the value of Soft limit control and does not trigger fault protection. When Hard limit control is enabled, a loss of communication with the meter will trigger the inverter into a fault protection state.

To ensure neutral continuity, the neutral of AC GRID must be connected together with the neutral of AC LOAD and must not be interrupted by switch.

If the Main Switch is used residual current protection device, it is recommended to choose type A protector for RCD with leakage current of 100mA or above (it is better to adjust according to the size of the system).

Fig. 5-17 Electrical connections (Plan A: CT/optional)

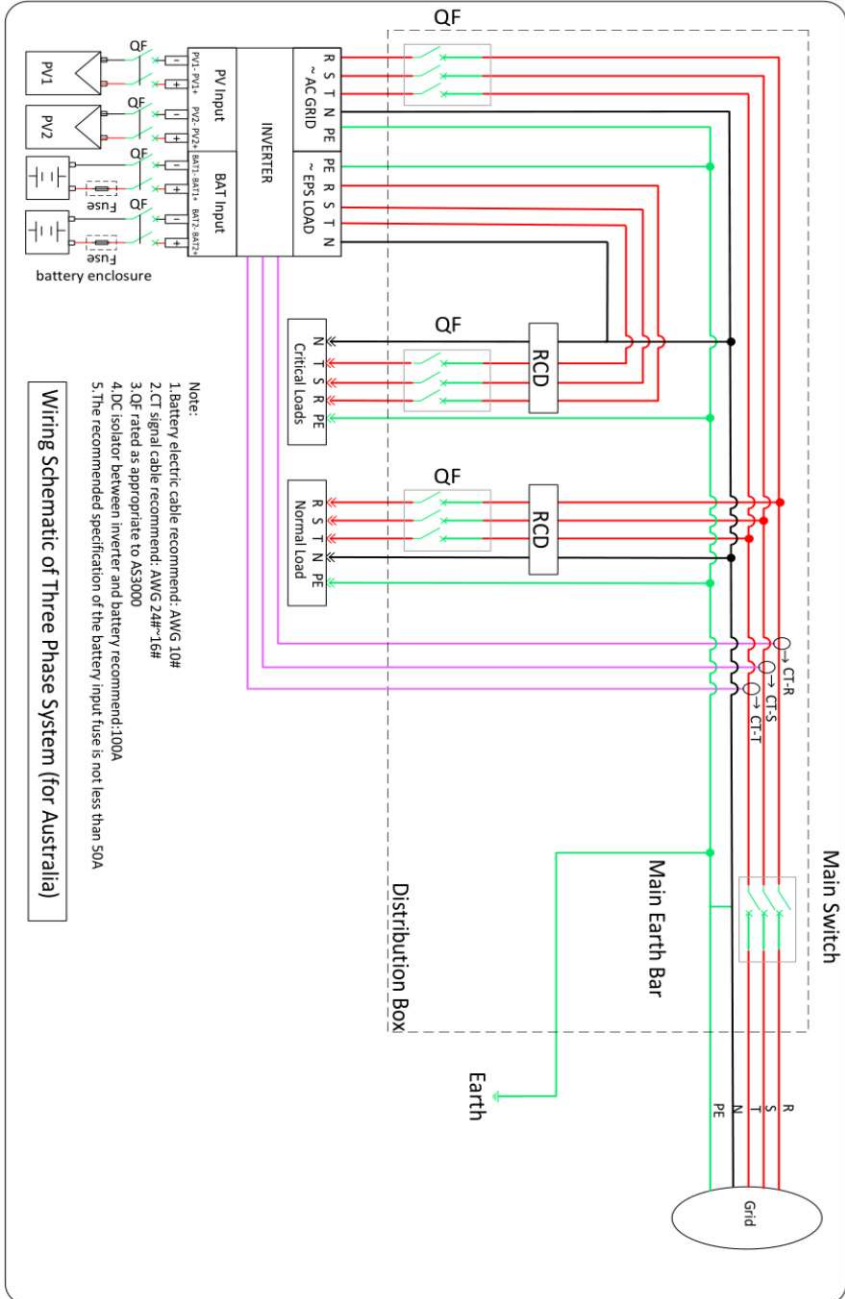
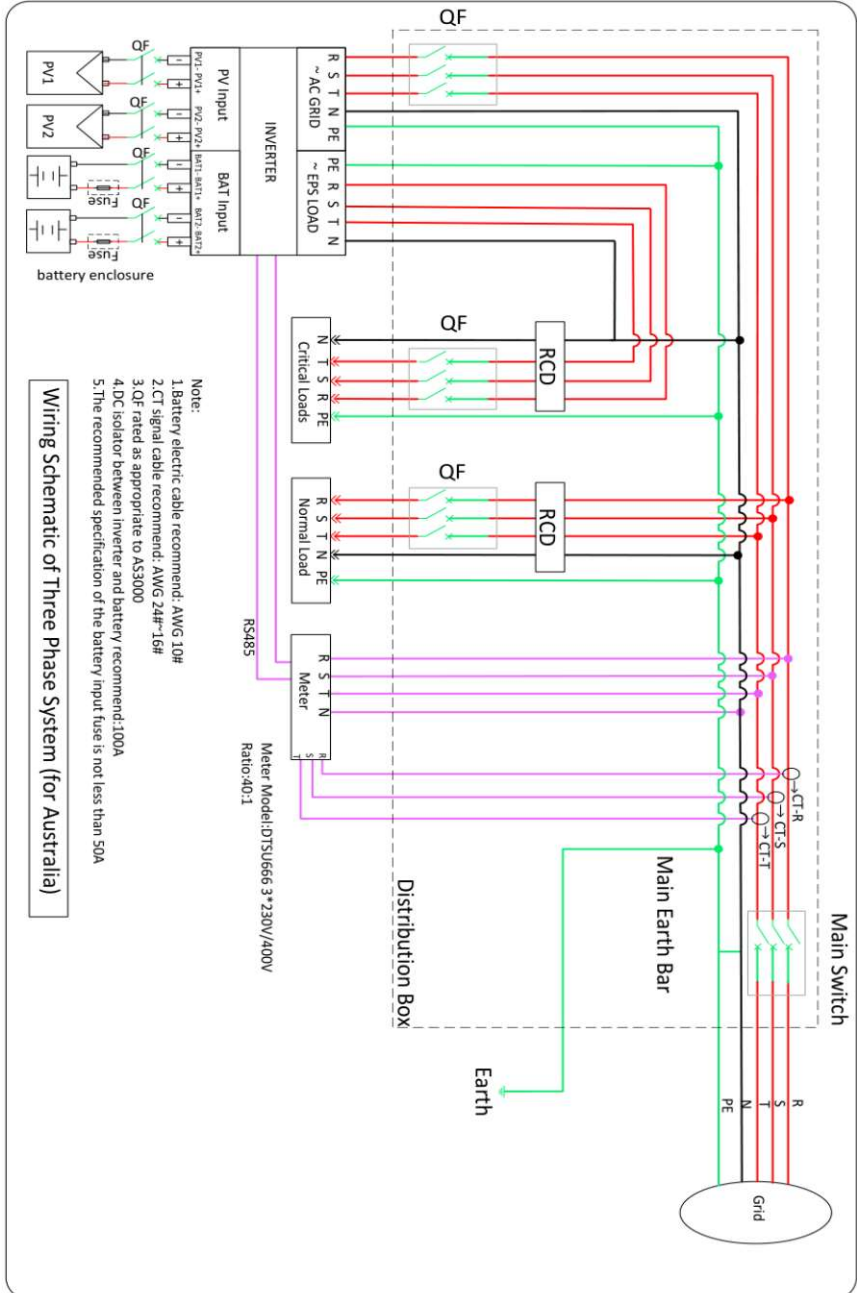

Fig. 5-18 Electrical connections (Plan B: Meter +CT/default)



5.7. Communication method

HYD 5-20KTL-3PH offer RS485 (standard) and WiFi/GPRS (optional) communication modes:

A. Single inverter communication :

1. RS485

Refer to the figure shown below, connect the RS485+ and RS485- of the inverter to the TX+ and TX- of the RS485 → USB adapter, and connect the USB port of the adapter to the computer. (NOTE: The length of the RS485 communication cable should be less than 1000 m)

Fig 5-19



2. WiFi/GPRS

Refer to the figure shown below.

Fig 5-20

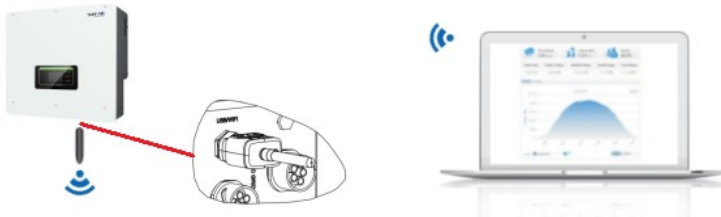

The operation information (generated energy, alert, operation status) of the inverter can be transferred to PC or uploaded to the server via WiFi/GPRS Users can choose to use web or APP for monitoring and viewing according to their needs. They need to register an account and bind the device with the WiFi/GPRS SN number. The SN number of the WiFi/GPRS shall be affixed to the package box and the WiFi/GPRS.

Web: <https://home.solarmanpv.com> (Recommended browser: Chrome58、Firefox49、IE9 and above version).

APP: Android: Go to Android Market and search “SolarMAN”.

IOS: Go to App Store and search “SolarMAN”.

SolarMAN-3.0-Web User Manual, Please visit the <https://doc.solarmanpv.com/web/#/7>.

SolarMAN-App User Manual, Please visit the <https://doc.solarmanpv.com/web/#/14>.

B. Communication between multiple inverters :

1. RS485

RS485 wires are connected in parallel between inverters, Connect the RS485+ and RS485- of the inverter to the TX+ and TX- of the RS485 → USB adapter; connect the USB port of the adapter to the computer.

(NOTE: When multiple inverters are connected via RS485 wires, set communication address to differentiate the inverters, please refer to this manual <7.4.1 System setting→8. Communication Addr.>)

Note: An isolated adapter must be used or the signal will be interfered.

Fig 5-21

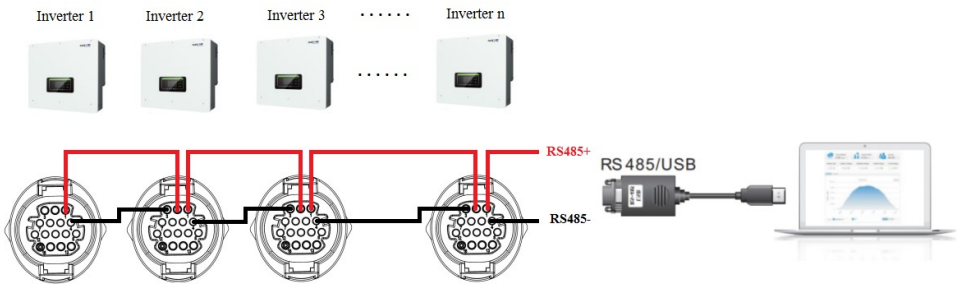

2. WI-FI/GPRS

Refer to the figure shown below, the monitoring mode is the same as that of a single unit.

Fig 5-22



6. Buttons and indicator lights

Fig.6-1 Buttons and indicator lights

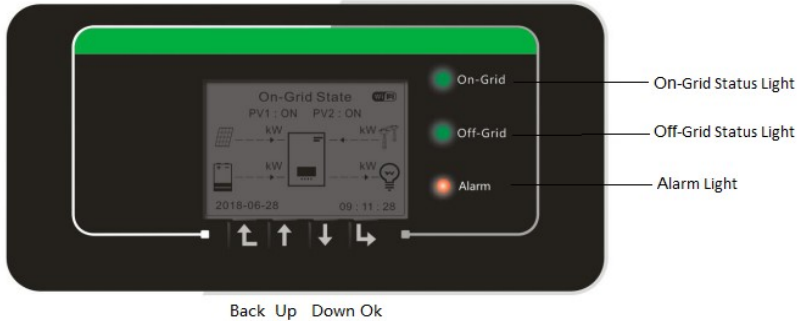

6.1. Buttons

- ✧ Press “Back” to the previous screen or enter the main interface.
- ✧ Press “Up” to the upper menu option or value plus 1.
- ✧ Press “Down” to the lower menu option or value minus 1.
- ✧ Press “OK” to select the current menu option or switch to the next digit.

6.2. Indicator lights and status

Status	On Grid Green light	Off-Grid Green light	Alarm Red light
On-grid	ON		
Standby (On-Grid)	Flashing		
Off-Grid		ON	
Standby (Off-Grid)		Flashing	
Alarm			ON

7. Operation (commission)

7.1. Double Check

Please double check the following before operation.

1. Inverter is firmly fastened to the mounting bracket on the wall.
2. PV+/PV- wires are firmly connected, polarity and voltage are correct.
3. BAT+/BAT- wires are firmly connected, polarity and voltage are correct.
4. DC isolator is correctly connected between battery & inverter, DC isolator: OFF.
5. GRID / LOAD cables are firmly / correctly connected.
6. AC circuit breaker is correctly connected between inverter GRID port & GRID, circuit breaker: OFF.
7. AC circuit breaker is correctly connected between inverter LOAD port & critical load, circuit breaker: OFF.
8. For lithium battery, please ensure that the communication cable has been correctly connected.
9. For the Inner BMS battery, please ensure that the NTC wire has been correctly connected.

7.2. First Time Setup (Starting up Or Shutdown)

IMPORTANT: Please follow the following procedure to switch ON inverter.

1. Make sure there's no power generation in inverter's phase.
2. Turn ON DC switch.
3. Switch ON the battery. Turn ON DC isolator between battery & inverter.
4. Turn ON AC circuit breaker between the inverter GRID port & GRID.
5. Turn ON AC circuit breaker between the inverter LOAD port & critical LOAD.
6. Inverter should start to operate now.

IMPORTANT: If the inverter needs to be shut down for electrical inspection, please follow the following steps

1. Press the "Back" on the main interface- select Advanced Settings on the main menu page- Press the "OK" on the main interface- Input Password 0001- Press the "OK"- select Switch On Off- Press the "OK"- set Switch Off- Press the "OK"-Set successfully, Inverter shutdown.

Note: After using the menu setting to shut down the inverter, the inverter should be checked and reenergizing, it still needs to be on the main menu page to start up. Press the "Back"- select Advanced Settings- Press the "OK"- Input Password 0001- Press the "OK"- select Switch On Off- Press the "OK"- set Switch On- Press the "OK"-Set successfully, Inverter start up.

2. Disconnect the AC circuit breaker connecting the inverter power GRID port to the power GRID.
3. Disconnect the AC breaker connecting the inverter LOAD port to the critical LOAD.
4. Disconnect the PV side DC switch.
5. Turn off the battery and disconnect the DC isolator between the battery and the inverter.
6. Make sure the LCD display is off, and wait for 5 minutes before checking the inverter.

You need to set the following parameters before inverter starts to operate.

Table 7- 1 Set the parameters

Parameter	Note
1.OSD Language Option	The default English.
2.System time setting and confirmation	If you are connected to the host computer such as collector or mobile phone APP, the time should have been calibrated to the local time.
*3.Safety parameter import	USB Disk to import locally/MobileAPP to import online.
4.Set the input channel	Default order: BAT1, BAT2, PV1, PV2
*5.Set battery parameters	Default values can be displayed according to the input channel configuration.
6. Setup is complete	

*3.Safety parameter import

USB Disk to import locally: The SOFARSOLAR provide safety code files to

professional operators. Put the files into USB Disk and insert the USB Disk into the USB interface of the inverter. In the step of safety code import, select the corresponding safety code files and confirm the import.

Mobile APP to import online: After the professional operator connects the machine to Bluetooth through the mobile APP, select the corresponding name of safety regulation in the APP guide function to import the file. This operation is only authorized by the installer and the equipment manufacturer, and cannot be operated by the end customer.

Once the country is set, it is read-only and can only be viewed and not modified by the end user.

Please contact and discuss with SOFARSOLAR technical support if you require a non standard parameter set.

Users can check the inverter safety firmware version, safety country and safety grid parameters through the system information in the inverter LCD menu.

Table 7-2 Safety chart of different countries

Code		Country	Code		Country
000	000*	Germany VDE4105	024	000	Cyprus
	001	Germany BDEW	025	000	India
	002*	Germany VDE0126	026	000	Philippines
001	000	Italia CEI-021 Internal	027	000	New Zealand
	001*	Italia CEI-016 Italia	028	000	Brazil
	002*	Italia CEI-021 External		001	Brazil LV
	003	Italia CEI0-21 In Areti		002	Brazil 230
002	000	Australia-A	029	003	Brazil 254
	008	Australia-B		000*	Slovakia VSD
	009	Australia-C		001*	Slovakia SSE
003	000	Spain RD1699		002*	Slovakia ZSD
004	000*	Turkey	033	000*	Ukraine
005	000	Denmark	034	000	Norway
	001	Denmark TR322		001	Norway-LV
006	000*	Greece Continent	035	000	Mexico LV
	001*	Greece island	038	000	Wide-Range-60Hz
007	000*	Netherland	039	000*	Ireland EN50438
008	000*	Belgium	040	000	Thailand PEA
009	000	UK G59/G99		001	Thailand MEA
		001	UK G83/G98	042	000
010	000	China	044	000	South Africa
	001	China Taiwan	046	000*	Dubai DEWG

011	000*	France		001	Dubai DEWG MV
	001	France FAR Arrete23	107	000*	Croatia
012	000	Poland	108	000*	Lithuania
013	000	Austria Tor Erzeuger			
014	000	Japan			
018	000	EU EN50438			
	001*	EU EN50549			
019	000	IEC EN61727			
020	000	Korea			
021	000	Sweden			
022	000	Europe General			

*Note: The national safety regulation enables the function of low pressure through by default, so the off-grid conversion time is greater than 20ms.

For The Australian Market:

For compliance with AS/NZS 4777.2:2020 please select from

- 002-000 Australia A (Australia Region A)
- 002-008 Australia B (Australia Region B)
- 002-009 Australia C (Australia Region C)

Please contact your local grid operator for which option to select

Note: By selecting 002-000 Australia A, 002-008 Australia B or 002-009 Australia C the power quality response mode and grid protection settings will be reset to their default values for Australia Region A, B, C respectively.

Default grid settings for different regions are shown in the following table:

Protective function	Protective function limit	Trip delay time	Maximum disconnection time
Undervoltage 2(V<<)	70V	1s	2s
Undervoltage 1(V<)	180V	10s	11s
Overtoltage 1(V>)	265V	1s	2s
Overtoltage 2(V>>)	275V	-	0.2s

	Region	Australia A	Australia B	Australia C	New Zealand
Under-frequency 1 (F<)	Protective function limit value	47Hz	47Hz	45Hz	45Hz
	Trip delay time	1s	1s	5s	1s
	Maximum disconnection time	2s	2s	6s	2s

Over-frequency 1 (F>)	Protective function limit value	52Hz	52Hz	55Hz	55Hz
	Trip delay time	-	-	-	-
	Maximum disconnection time	0.2s	0.2s	0.2s	0.2s

Default volt-watt settings for different regions are shown in the following table:

Region	Default value	V_{L2}	V_{L1}	V_{W1}	V_{W2}
Australia A	Voltage	207	215	253	260
	Inverter output (P) % of S_{rated}	20%	100%	100%	20%
Australia B	Voltage	195	215	250	260
	Inverter output (P) % of S_{rated}	0%	100%	100%	20%
Australia C	Voltage	207	215	253	260
	Inverter output (P) % of S_{rated}	20%	100%	100%	20%

Default volt-var settings for different regions are shown in the following table:

Region	Default value	V_{V1}	V_{V2}	V_{V3}	V_{V4}
Australia A	Voltage	207	220	240	258
	Inverter reactive output (Q) % of S_{rated}	44% supplying	0%	0%	60% sinking
Australia B	Voltage	205	220	235	255
	Inverter reactive output (Q) % of S_{rated}	30% supplying	0%	0%	40% sinking
Australia C	Voltage	215	230	240	255
	Inverter reactive output (Q) % of S_{rated}	44% supplying	0%	0%	60% sinking



Caution

It's very important to make sure that you have selected the correct country code according to requirements of local authority. Please consult qualified electrical engineer or personnel from electrical safety authorities about this.

Shenzhen SOFARSOLAR Co., Ltd. is not responsible for any consequences arising out of incorrect country code selection.

*5.Set battery parameters (Take the default input channel configuration as an example).Start with battery 1 and work your way up to battery n.

Battery Type	Type of band communication protocol	no protocol type
	1.Battery Address	1.Battery Capacity
	2.Battery Charge Current Limit	2.Battery Nominal Voltage
	3.Battery Discharge Current Limit	3.Battery Cell Type
	4.Battery DOD	4.Battery Charge Current Limit
		5.Battery Discharge Current Limit
		6.Battery DOD

Table 7-2 Default values for other Settings

Item	The default state
Energy Storage Mode	Self-use mode
EPS Mode	Disable
Anti Reflux	Disable
IV Curve Scan	Disable
Logic interface	Disable

7.3. Setting power quality response modes

The setting and viewing method of power quality response mode and power grid protection.

Once the power quality and grid settings have been selected at commissioning, these settings will be locked, end customers cannot modify by themselves. These setting require professional and technical personnel to conduct them by issuing and transmitting instructions on the remote monitoring platform, on the premise that the data acquisition rod is installed (WiFi/GPRS/Ethernet) . And the account must be authorized by SOFARSOLAR.

- Power quality settings can be set/view/changed by logging onto solarmanpv.com.
- Access to solarmanpv.com is restricted to authorised personnel only (refer to Section 5.7 for instructions on accessing solarmanpv.com).
- An account must be created to use solarmanpv.com.

- Technical personnel can send control instructions on the monitoring page to modify the mode and parameters of the machine, and the corresponding instructions need to be provided by internal professionals.

7.4. Menu

Fig 7-1. Main interface

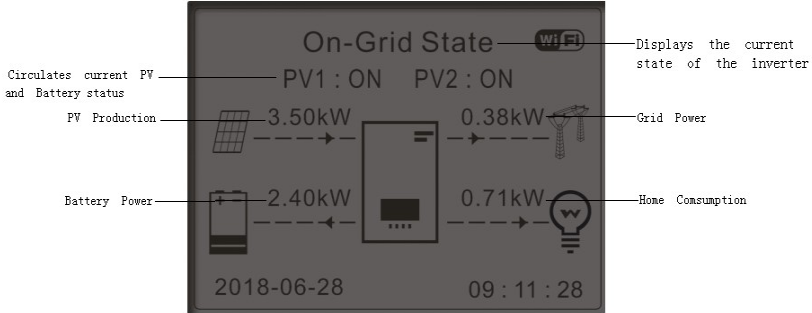

In the main interface, press “Down” button to enter grid/battery parameters page.

Main interface	Down↓	Grid Output Information
		Grid(V) R.....***.*V
		Grid(V) S.....***.*V
		Grid(V) T.....***.*V
		AC Current R.....**.*A
		AC Current S.....**.*A
		AC Current T.....**.*A
		Frequency.....**.*Hz
	Down↓	Battery Information (1)
		Batt1 (V).....****.*V
		Batt1 Curr.....**.*A
		Batt1 Power.....**.*KW
		Batt1 Temp.....*°C
		Batt1 SOC.....**0%
		Batt1 SOH.....**0%
		Batt1 Cycles.....*T
	Down↓	Battery Information (2)
		Batt2 (V).....****.*V
		Batt2 Curr.....**.*A
		Batt2 Power.....**.*KW
		Batt2 Temp.....*°C
		Batt2 SOC.....**0%
		Batt2 SOH.....**0%
		Batt2 Cycles.....*T

In the main interface, press “Up” button to enter PV parameters page.

Main interface	Up↑	<table border="1"> <tr><td>PV Information</td></tr> <tr><td>PV1 Voltage.....****.*V</td></tr> <tr><td>PV1 Current.....**.*A</td></tr> <tr><td>PV1 Power.....**.*KW</td></tr> <tr><td>PV2 Voltage.....****.*V</td></tr> <tr><td>PV2 Current.....**.*A</td></tr> <tr><td>PV2 Power.....**.*KW</td></tr> <tr><td>Inverter Temp.....*°C</td></tr> </table>	PV Information	PV1 Voltage.....****.*V	PV1 Current.....**.*A	PV1 Power.....**.*KW	PV2 Voltage.....****.*V	PV2 Current.....**.*A	PV2 Power.....**.*KW	Inverter Temp.....*°C
PV Information										
PV1 Voltage.....****.*V										
PV1 Current.....**.*A										
PV1 Power.....**.*KW										
PV2 Voltage.....****.*V										
PV2 Current.....**.*A										
PV2 Power.....**.*KW										
Inverter Temp.....*°C										

In the main interface, press “back” button to enter main menu. The main menu has the following six options.

Main interface	Back	<table border="1"> <tr><td>1.System Setting</td></tr> <tr><td>2.Advanced Setting</td></tr> <tr><td>3.Energy Statistic</td></tr> <tr><td>4.System Information</td></tr> <tr><td>5.Event List</td></tr> <tr><td>6.Software Update</td></tr> </table>	1.System Setting	2.Advanced Setting	3.Energy Statistic	4.System Information	5.Event List	6.Software Update
1.System Setting								
2.Advanced Setting								
3.Energy Statistic								
4.System Information								
5.Event List								
6.Software Update								

7.4.1 System setting

1.System Setting	OK	<table border="1"> <tr><td>1.Language Settings</td></tr> <tr><td>2.Time</td></tr> <tr><td>3.Safety Param.</td></tr> <tr><td>4.Energy Storage Mode</td></tr> <tr><td>5.Auto Test (Only for Italy)</td></tr> <tr><td>6.Input Channel Config</td></tr> <tr><td>7.EPS Mode</td></tr> <tr><td>8.Communication Addr.</td></tr> </table>	1.Language Settings	2.Time	3.Safety Param.	4.Energy Storage Mode	5.Auto Test (Only for Italy)	6.Input Channel Config	7.EPS Mode	8.Communication Addr.
1.Language Settings										
2.Time										
3.Safety Param.										
4.Energy Storage Mode										
5.Auto Test (Only for Italy)										
6.Input Channel Config										
7.EPS Mode										
8.Communication Addr.										

1. Language Settings

Used to set the menu display language.

1.Language Settings	OK	<table border="1"> <tr><td>1. 中文</td></tr> <tr><td>2. English</td></tr> <tr><td>3. Italiano</td></tr> <tr><td>4.</td></tr> </table>	1. 中文	2. English	3. Italiano	4.	OK
1. 中文							
2. English							
3. Italiano							
4.							

2. Time

Set the system time for the inverter.

2.Time	OK	Time
--------	----	------

2020-05-13 17:07:00

3. Safety Parameter

User can modify the Safety parameter of the machine through the USB flash disk, and the user needs to copy the parameter information that needs to be modified into the USB flash disk card in advance.

Note: To enable this feature, please contact the SOFARSOLAR technical support .

4. Energy Storage Mode

4.Energy Storage Mode	OK	1.Self-use Mode	OK
		2.Time-of-use Mode	
		3.Timing Mode	
		4.Passive Mode	OK

Self-use Mode

In Self-use mode, inverter will automatically charge & discharge the battery.

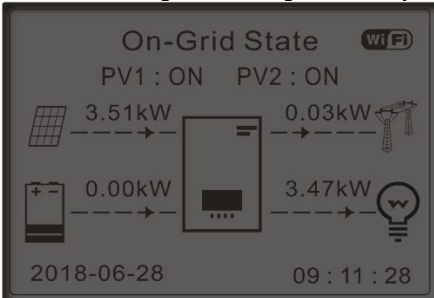
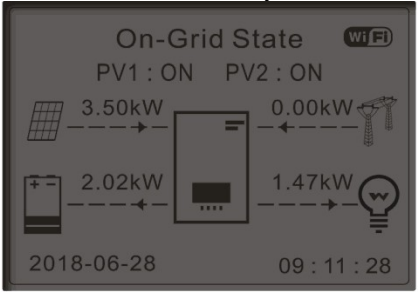
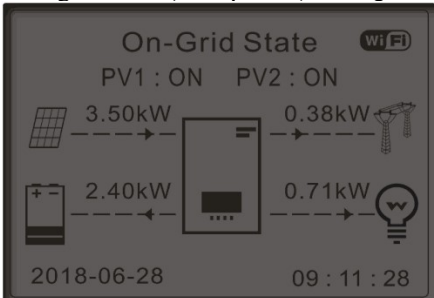
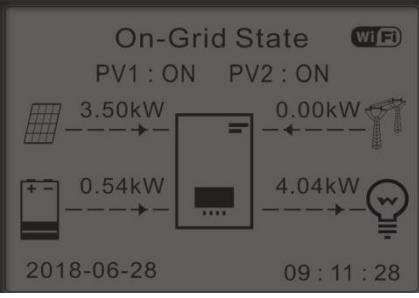
<p>1) If PV generation = LOAD consumption ($\Delta P < 100W$) inverter won't charge or discharge the battery.</p> 	<p>2) If PV generation > LOAD consumption, the surplus power will be stored in the battery.</p> 
<p>3) If the battery is full(or already at Max Charge Power), excess power will be generated (or exported) to the grid.</p> 	<p>4) If PV generation < LOAD consumption, it will discharge the battery to supply power to load.</p> 
<p>5) If PV generation + Battery < LOAD consumption, inverter will import</p>	

power from the grid.

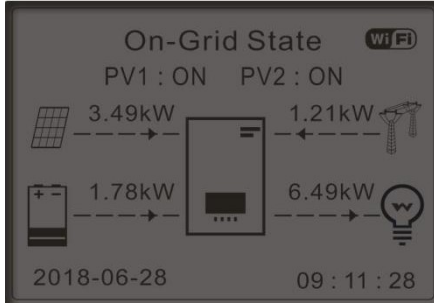

Note: If power generate (or export) to the grid is not allowed, a Anti Reflux Meter/CT needs to be installed, and “Anti Reflux Control” function needs to be enabled.

For details, please refer to Fig 5-15 and Fig 5-16 of this manual and setting method in Section 7.4.2.

Time-of-use Mode

If electricity is more expensive in high demand time (peak rate) & electricity is much cheaper in low demand time (off-peak rate).

You can select an off-peak period to charge your battery. Outside the off-peak charge period, inverter is working in Self-use Mode.

If your family normally go to work/school on weekdays & stay at home on weekends, which means the home electricity consumption is much higher on weekends. Thus, you need to store some cheap electricity on weekends only. This is possible using our Time-of-use mode.

In summer, if your PV system can produce more electricity than your home electricity consumption. Then you don't need to set an off-peak charge period to charge your battery in summer at all. When the system time is in the "off-peak charge period", If the battery SOC is lower than the set SOC value, Charge the battery with the set "Charge" power. Otherwise, excess PV power is stored only when the PV power is greater than the load power. You can select an effective date (normally winter) for Time-of-use mode in this case. Outside the effective date, inverter is working in Self-use Mode.

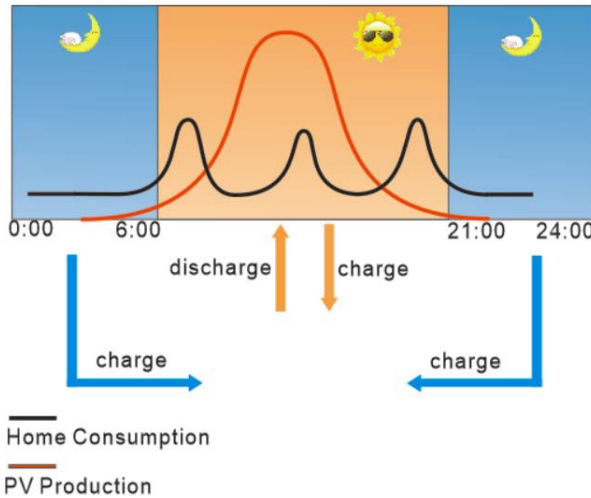

You can set multiple Time-of-use rules to meet your more complex requirement. Right now we support 4 rules maximum (rule 0/1/2/3).

*The Effective dates of multiple rules can be overlapped. When the dates overlap, the rule with the smaller sequence number takes the off-peak charge first. For example, Rule0 sets the off-peak charge period from 2:00 to 5:00 on January 1 If you want to set the off-peak charge period from 1:00-1:59 to 5:01-6:00 on January 1, then you want to set the off-peak charge period from 1:00-1:59 to 5:01-6:00 on

January 1. If you want to set the off-peak charge period from 1:00-1:59 to 5:01-6:00 on January 1, then you want to set the off-peak charge period from 1:00-1:59 to 5:01-6:00 on January 1, then you want to set the off-peak charge period from 1:00-1:59 to 5:01-6:00 on January 1 Off-peak charge action, the rest of the time is in self-use mode.

2. Time-of-use Mode

OK

Set Time-of-use Mode			
Rules. 0:	Enabled/Disabled		
From	To	SOC	Charge
02h00m	-04h00m	070%	01000W
Effective	date		
Dec.22	-	Mar.21	
Weekday	select		
Mon. Tue. Wed. Thu.			
Fri. Sat. Sun.			

Set Timing Mode

Changing the value of a rule can set multiple timing rules.

*Rule 0/1/2/3. The charging and discharging periods can be switched on separately. Multiple rules can take effect at the same time. The rule with the smaller sequence number is executed first. For example, Rule0 sets the charging period from 2:00 to 5:00, and the discharging period from 6:00 to 10:00. Rule1 sets the charging period from 3:00 to 8:00 and the discharging period from 9:00 to 11:00. Then the period from 2:00 to 8:00 is the charging period, and the period from 8:00 to 11:00 is the discharging period.

Enabled/Disabled Indicates that the charge and discharge functions are Enabled or Disabled. Enabled charge/Enabled discharge indicates that the charge and discharge functions are Enabled separately.

3. Timing Mode

OK

Timing Mode	
Rules. 0:	Enabled/Disabled
/Enabled charge/Enabled discharge	
Charge Start	22 h 00 m
Charge End	05 h 00 m
Charge Power	02000 W
DisCharge Start	14 h 00m
DisCharge End	16 h 00m
DisCharge Power	02500 W

Passive Mode

For more detailed information, please ask representative of SOFAR to get a copy of passive mode communication protocol.



5. Auto Test (ONLY for Italian Market)

5.Auto Test	OK	1.Autotest Fast
		2.Autotest STD

Auto test Fast

1.Autotest Fast OK

Start Auto test	Press "Ok" to start
Testing 59.S1...	
↓	Wait
Test 59.S1 OK!	
↓	Wait
Testing 59.S2...	
↓	Wait
Test 59.S2 OK!	
↓	Wait
Testing 27.S1...	
↓	Wait
Test 27.S1 OK!	
↓	Wait
Testing 27.S2...	
↓	Wait
Test 27.S2 OK!	
↓	Wait
Testing 81>S1...	
↓	Wait
Test 81>S1 OK!	
↓	Wait
Testing 81>S2...	
↓	Wait
Test 81>S2 OK!	
↓	Wait
Testing 81<S1...	
↓	Wait
Test 81<S1 OK!	
↓	Wait
Testing 81<S2...	
↓	Wait
Test 81<S2 OK!	

↓	Press “Ok”
Auto Test OK!	
↓	Press “Down”
59.S1 threshold 253V 900ms	
↓	Press “Down”
59.S1: 228V 902ms	
↓	Press “Down”
59.S2 threshold 264.5V 200ms	
↓	Press “Down”
59.S2: 229V 204ms	
↓	Press “Down”
27.S1 threshold 195.5V 1500ms	
↓	Press “Down”
27.S1: 228V 1508ms	
↓	Press “Down”
27.S2 threshold 34.5V 200ms	
↓	Press “Down”
27.S2: 227V 205ms	
↓	Press “Down”
81>.S1 threshold 50.5Hz 100ms	
↓	Press “Down”
81>.S1 49.9Hz 103ms	
↓	Press “Down”
81>.S2 threshold 51.5Hz 100ms	
↓	Press “Down”
81>.S2 49.9Hz 107ms	
↓	Press “Down”
81<.S1 threshold 49.5Hz 100ms	
↓	Press “Down”
81<.S1 50.0Hz 105ms	
↓	Press “Down”
81<.S2 threshold 47.5Hz 100ms	
↓	Press “Down”
81<.S2 50.1Hz 107ms	

Auto test STD

2.Autotest STD

 Press OK to start

The test procedure is same as Auto test Fast, but it’s much more time consuming.

6. Input Channel Config

If only one battery group is used, you need to disable channel 2.

6.Input Channel Config

OK

Input Channel Config	
Input Channel1	Battery input1
	Disable
Input Channel2	Battery input1
	Battery input2
	Disable
Input Channel3	PV input 1
	Disable
Input Channel4	PV input 1
	PV input 2
	Disable

Down OK

Down

Down

Down

7. EPS Mode

*The EPS mode is unavailable when the battery is not connected.

7.EPS Mode

OK

1.EPS Mode Control

OK

1.Enable EPS Mode

OK

2.Disable EPS Mode

1) If PV generation > LOAD consumption ($\Delta P > 100W$), inverter will charge battery.

2) If PV generation = LOAD consumption, inverter wont' charge or discharge battery.

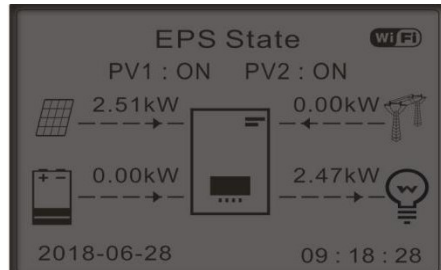
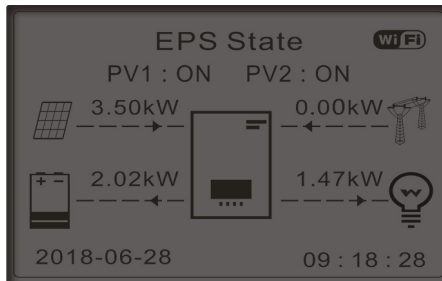

3) If PV generation < LOAD consumption ($\Delta P > 100W$), inverter will discharge battery.

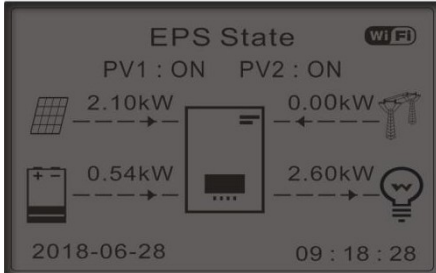

4) If PV generation is normal, but LOAD consumption=0, the surplus power will be stored in the battery.

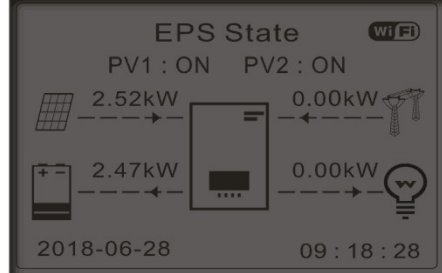

8. Communication Addr

8.Communication Addr	OK	1.Communication Addr	OK
		2.Baud Rate	OK

7.4.2 Advanced setting

2.Advanced setting OK

Input 0001

1.Battery Parameter
2.Battery Active
3.Anti Reflux
4.IV Curve Scan
5.Logic interface Control
6.Factory Reset
7.Parallel setting
8.Bluetooth Reset
9.CT Calibration
10.Switch On Off
11.Unbalanced Support

1. Battery Parameter

1.Battery Parameter	OK	Battery Parameter1	OK
		Battery Parameter2	OK

A. Inner BMS

1.Battery Parameter	OK	1.Battery Type	5.Max Charge (A)
		2.Battery Capacity	6.Max Discharge (A)
		3.Nominal Bat Voltage	7.*Discharg Depth
		4.Battery CellType	8.Save

OK

B.PYLON/SOFAR

1.Battery Parameter	OK	1.Battery Type	5.Discharg Depth	OK
		2.Battery Address	6.Set Force Charge Time	
		3.Max Charge (A)	7.Save	
		4.Max Discharge (A)		

2.Battery Address	BatteryAddress 1	00
	BatteryAddress2	Not Use
	BatteryAddress 3	Not Use
	BatteryAddress4	Not Use

Depth of Discharge

For example: if Discharge Depth = 50% & EPS Discharge Depth = 80%.

While grid is connected: Inverter won't discharge the battery when its SOC is less than 50%.

In case of blackout: Inverter will work in EPS mode (if EPS mode is enabled) & keep discharging the battery till battery SOC is less than 20%.

7.Depth of Discharge	OK	Discharge Depth	50%
		EPS Discharge Depth	80%
		EPS Restore Depth	20%

2. Battery Active

2.Battery Active	OK	Automatic activation	Enable	OK
			Disable	
		Mandatory activation		

This function provides different ways to activate the battery after battery dormancy. When the automatic activation switch-disable, when the input and output meet the conditions for battery activation, the inverter will not automatically activate the battery, it is necessary to set the mandatory activation LCD to enable the inverter to activate the battery. When the automatic activation switch-enabling, the inverter can automatically activate the battery when the input and output meet the conditions for battery activation. When manual click settings force activation, the inverter forces the activation of dormant batteries.

3. Anti Reflux

The user can enable ‘Anti Reflux’ to limit the active or apparent power level output from the inverter to the grid.

Refer to 5.6.5 for connection of the system when using Anti Reflux Control function.

3.Anti Reflux	OK	1.Anti Reflux Mode	OK	Disable
		2.Control Mode	OK	Anti Reflux
		3.Control Type	OK	Three phase limit
		4.Power limit		Generation limit
				Export limit
				Soft limit
				Hard limit
				Both
				***KW(VA)

Anti Reflux Mode: Anti Reflux and Three phase limit

Anti Reflux Mode provides control of the three-phase active or apparent power output from the inverter to the grid and the active or apparent power of each phase does not exceed the **Power limit**.

Three phase limit Mode provides control of the active or apparent power output from the inverter to the grid, allowing one of the three-phase active or apparent power to exceed the **Power limit**, and controls the sum of the three-phase active or apparent power output to the grid to not exceed the **Power limit**.

Control Mode: Generation limit and Export limit

Generation limit mode provide control to limit the apparent power level output from the inverter to the grid.

Export limit mode provide control to limit the active power level output from the inverter to the grid.

Control Type: Soft limit and Hard limit

Soft limit shall be utilized to control the active or apparent power output level such that the **Hard limit** is not exceeded. Where **Power limit** is exceeded, **Soft limit** control function shall operate to reduce the the active or apparent power output of the inverter to less than **Power limit**.

Hard limit shall be utilized to provide protection when **Power limit** is exceeded because the **Soft limit** is out of control or not being used. **Hard limit** control

function shall operate to disconnect the inverter from the grid and trigger overload protection.

4. IV Curve Scan

The user can enable “IV Curve Scan” (MPPT scan) to make inverter to find the global max power point periodically to deliver max power from a partially shaded PV array.

The user can input scan period or make inverter to perform a scan right away.

4.IV Curve Scan	OK	1.Scan Control	OK	Enable
		2.Scan Period	OK	Disable
		3.Force Scan	OK	***min

5. Logic interface Control

Enable or disable logical interfaces. Please refer to this manual 5.6.2, inverter logic interface connection for details.

5.Logic interface Control	OK	Enable	OK
		Disable	OK

6. Factory Reset

6.Factory Reset	OK	1.Clear Energy Data	OK
		2.Clear Events	OK

Clean the inverter of the total power generation.

1.Clear Energy Data	OK	Clear	OK
		Cancel	

Clean up the historical events recorded in the inverter.

2..Clear Events	OK	Clear Events?	OK
-----------------	----	---------------	----

7. Parallel setting

Please refer to <5.6.4 Link Port 0&1-Cascade communication interface> for the connection method of the parallel system.

7.Parallel setting	OK	1.Parallel Control
		2.Parallel Primary-Replica
		3.Parallel Address
		4.Save

1. Parallel Control: Enable or disable parallel functions. Both the master and the slave must enable this function.
2. Parallel Primary-Replica: Set up the Primary and Replica. Select one inverter as

the Primary and set the others to Replica.

3. Parallel Address: Set the parallel address. Each inverter needs to set a parallel address, and the parallel address in a parallel system cannot be repeated.

(NOTE: The parallel address is different from the communication address used for monitoring.)

4. Save: Save after the setup is complete.

8. Bluetooth Reset

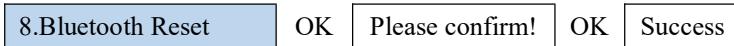

9. CT Calibration

To calibrate the direction and phase of the CT, the battery should be charged or discharged when using this function.

A. The input must be connected to the battery, and the output must be connected to the grid for normal calibration, otherwise the calibration will fail.

B. When carrying unbalanced load, the calibration will fail. It is recommended to turn off the load when carrying out CT calibration.



Check if the battery is charging or discharging when calibration fails.

10. Switch On Off

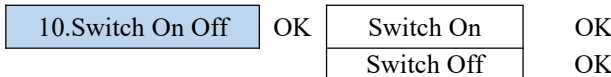

Function: the inverter can be controlled by the inverter switch machine through this menu, so that the inverter can be shut down, the inverter can stop working and turn into standby state, and the inverter can be to normal output working state. This function can effectively and safely control the inverter switch machine and facilitate installation and maintenance.

11. Unbalanced Support

The default is prohibited.

Application scenarios: When the system is connected with three-phase unbalanced load or single-phase load, the inverter outputs power to the load, and the remaining two-phase or three-phase unbalanced output is incorporated into the power grid. This reduces the quality of the grid, and photovoltaic power generation is not used

most efficiently.

The customer can set the enable to turn on the three-phase unbalance support, and the inverter can detect and identify the three-phase current unbalance at the common connection points of the grid in the system through the meter or CT. The three-phase unbalanced current is output pertinently to compensate the current imbalance at the public connection point, so that the current at the public connection point of the power grid is always kept in dynamic balance. It can effectively improve the quality of power grid and enhance user benefit.

7.4.3 Energy Statistic

3.Energy Statistic	OK	Today
		PV***KWH
		Load.....***KWH
		Export.....***KWH
		Import.....***KWH
		Charge.....***KWH
		Discharge.....***KWH
	Down↓	Month
		PV***KWH
		Load.....***KWH
		Export.....***KWH
		Import.....***KWH
		Charge.....***KWH
		Discharge.....***KWH
	Down↓	Year
		PV***KWH
		Load.....***KWH
		Export.....***KWH
		Import.....***KWH
		Charge.....***KWH
		Discharge.....***KWH
	Down↓	Lifetime
		PV***KWH
		Load.....***KWH
		Export.....***KWH
		Import.....***KWH
		Charge.....***KWH
		Discharge.....***KWH

7.4.4 System information

4.System information	OK	1.Inverter Info
		2.Battery Info
		3.Safety Param.

1.Inverter Info	OK	Inverter Info (1)
		Product SN
		Software Version
		Main DSP Software Version
		Slave DSP Software Version
	Down↓	Inverter Info (2)
		Hardware Version
		Power Level
		Country
	Down↓	Inverter Info (3)
	Input Channel1	
	Input Channel2	
	Input Channel3	
	Input Channel4	
Down↓	Inverter Info (4)	
	Energy Storage Mode	
	RS485 Address	
	EPS Mode	
	IV Curve Scan	
Down↓	Inverter Info (5)	
	Logic Interface Control	
	PF Time Setting	
	QV Time Setting	
	Power Factor	
Down↓	Inverter Info (6)	
	Anti Reflux	
	Insulation resistance	

2.Battery Info	OK	Battery1/2 info(1)
		Battery Type
		Battery Capacity
		Over (V) Protection
		Discharge Depth
	Down↓	Inverter1/2 Info (2)
		Max Charge (A)
		Max Charge (V)

		Max Discharge (A)
		Min Discharge (V)
	Down↓	Inverter1/2 Info (3)
		Low(V)Protection
		Nominal Bat Voltage
3.Safety Param.	OK	Safety Param.(1)
		OVP 1
		OVP 2
		UVP 1
		UVP 2
	Down↓	Safety Param. (2)
		OFPI
		OFPI 2
		UFP 1
		UFP 2
	Down↓	Safety Param. (3)
		OVP 10mins

7.4.5 Event List

Event List is used to display the real-time event records, including the total number of events and each specific ID No. and happening time. User can enter Event List interface through main interface to check details of real-time event records, Event will be listed by the happening time, and recent events will be listed in the front.

5.Event List	OK	1.Current Event List	OK	ID042 Iso Fault
		2.History Event List		

2.History Event List	OK	1.ID001 2020-4-3 14:11:45	OK	1.ID001 GridOVP
		2.ID005 2020-4-3 11:26:38		2.ID005 GFCI

7.4.6 Software Update

HYD 5-20KTL-3PH inverters offer software upgrade via USB flash drive to maximize inverter performance and avoid inverter operation error caused by software bugs.

Step 1 Insert the USB flash drive into the compute.

Step 2 SOFARSOLAR will send the Software code to the user who needs to update.

After user receive the file, please decompressing file and cover the original file in USB flash drive.

Step 4 Insert the USB flash drive into the USB/Wifi interface.

Step 5 Then turn on DC switch.

Step 6

6.Software Update	OK	Input password	OK	Input 0715
				Start Update
				Updating DSP1
				Updating DSP2
				Updating ARM

Step 7 If the following errors occur, please upgrade again. If this continues many times, contact technical support for help.

USB Fault	MDSP File Error	SDSP File Error
ARM File Error	Update DSP1 Fail	Update DSP2 Fail
Update ARM Fail		

Step 8 After the update is completed, turn off the DC breaker, wait for the LCD screen extinguish, then restore the WiFi connection and then turn on the DC breaker and AC breaker again, the inverter will enters the running state. User can check the current software version in System Info.>>>Soft Version.

8. Troubleshooting

This section contains information and procedures for solving possible problems with the inverter.

➤ This section help users to identify the inverter fault. Please read the following procedures carefully:

✧ Check the warning, fault messages or fault codes shown on the inverter screen, record all the fault information.

✧ If there is no fault information shown on the screen, check whether the following requirements are met:

- Is the inverter mounted in a clean, dry place with good ventilation?

- Is the DC switch turned ON?

- Are the cables adequately sized and short enough?

- Are the input and output connections and wiring in good condition?

- Are the configuration settings correct for the particular installation?

- Are the display panel and the communication cables properly connected and undamaged?

➤ Follow the steps below to view recorded problems: Press “Back” to enter the main menu in the normal interface. In the interface screen select "Event List", then press “OK” to enter events.

➤ Earth Fault Alarm

This inverter complies with AS/NZS 5033 for earth fault alarm monitoring.

If an Earth Fault Alarm occurs, the fault will be displayed on the LCD screen, the red light will be on, and the fault can be found in the history of the fault. For the machine installed with Wi-Fi/GPRS, the alarm information can be seen on the corresponding monitoring website, and can also be received by the APP on the mobile phone.

When the inverter is connected to the battery system, when the battery system has ground fault/leak alarm in accordance with AS/NZS 5139, the inverter will also alarm. The alarm method is the same AS above.

	The inverter must be installed in a high traffic area where the fault would be seen.
Attention	

➤ Event List information

Table 8-1 Event list

Code	Name	Description	Solution
ID001	Grid OVP	The grid voltage is too high	If the alarm occurs occasionally, the possible cause is that the electric grid is abnormal occasionally. Inverter will automatically return to normal operating status when the electric grid's back to normal.
ID002	Grid UVP	The grid voltage is too low	
ID003	Grid OFP	The grid frequency is too high	
ID004	Grid UFP	The grid frequency is too low	If the alarm occurs frequently, check whether the grid voltage/frequency is within the acceptable range. If yes, please check the AC circuit breaker and AC wiring of the inverter. If the grid voltage/frequency is NOT within the acceptable range and AC wiring is correct, but the alarm occurs repeatedly, contact technical support to change the grid over-voltage, under-voltage, over-frequency, under-frequency protection points after obtaining approval from the local electrical grid operator.
ID005	GFCI	Charge Leakage Fault	Internal faults of inverter, switch OFF inverter, wait for 5 minutes, then switch ON inverter. Check whether the problem is solved. If no, please contact technical support.
ID006	OVRT fault	OVRT function is faulty	
ID007	LVRT fault	LVRT function is faulty	
ID008	Island Fault	Island protection error	
ID009	GridOVPIstant1	Transient overvoltage of grid voltage 1	
ID010	GridOVPIstant2	Transient overvoltage of grid voltage 2	
ID011	VGrid Line Fault	Power grid line voltage error	
ID012	Inv OVP	Inverter voltage overvoltage	
ID017	HwADFaultIGrid	Power grid current sampling error	
ID018	HwADFaultDCI	Wrong sampling of dc component of grid current	
ID019	HwADFaultVGri	Power grid voltage	

	d(DC)	sampling error (DC)	
ID020	HwADFaultVGri d(AC)	Power grid voltage sampling error (AC)	
ID021	GFCIDeviceFault (DC)	Leakage current sampling error(DC)	
ID022	GFCIDeviceFault (AC)	Leakage current sampling error(AC)	
ID023	HwADFaultDCV	Error in dc component sampling of load voltage	
ID024	HwADFaultIdc	Dc input current sampling error	
ID029	ConsistentFault_ GFCI	Leakage current consistency error	
ID030	ConsistentFault_ Vgrid	Grid voltage consistency error	
ID033	SpiCommFault(D C)	SPI communication error (DC)	
ID034	SpiCommFault(A C)	SPI communication error (AC)	
ID035	SChip_Fault	Chip error (DC)	
ID036	MChip_Fault	Chip error (AC)	
ID037	HwAuxPowerFau lt	Auxiliary power error	
ID041	Relay Fail	Relay detection failure	
ID042	Iso Fault	Low insulation impedance	Check the insulation resistance between the photovoltaic array and ground (ground), if there is a short circuit, the fault should be repaired in time.
ID043	PEConnectFault	Ground fault	Check ac output PE wire for grounding.
ID044	ConfigError	Error setting input mode	Check the input mode (parallel/independent mode) Settings for the inverter. If not, change the input mode.
ID045	CTDisconnect	CT error	Check whether the CT wiring is correct.
ID049	TempFault_Bat	Battery temperature protection	
ID050	TempFault_Heat Sink1	Radiator 1 temperature protection	For Inner BMS battery, make sure that the battery NTC cable is properly connected. Make sure the inverter is installed where there is no direct sunlight. Please ensure that the inverter is installed in a cool/well ventilated place. Ensure the inverter is installed vertically and the ambient temperature is below the inverter temperature limit.
ID051	TempFault_Heat Sink2	Radiator 2 temperature protection	
ID052	TempFault_Heat Sin3	Radiator 3 temperature protection	
ID053	TempFault_Heat Sink4	Radiator 4 temperature protection	
ID054	TempFault_Heat Sin5	Radiator 5 temperature protection	
ID055	TempFault_Heat Sin6	Radiator 6 temperature protection	

ID057	TempFault_Env1	Ambient temperature 1 protection	
ID058	TempFault_Env2	Ambient temperature 2 protection	
ID059	TempFault_Inv1	Module 1 temperature protection	
ID060	TempFault_Inv2	Module 2 temperature protection	
ID061	TempFault_Inv3	Module 3 temperature protection	
ID065	VbusRmsUnbalance	Unbalanced bus voltage RMS	
ID066	VbusInstantUnbalance	The transient value of bus voltage is unbalanced	Internal faults of inverter, switch OFF inverter, wait for 5 minutes, then switch ON inverter. Check whether the problem is solved. If no, please contact technical support.
ID067	BusUVP	Busbar undervoltage during grid-connection	
ID068	BusZVP	Bus voltage low	
ID069	PVOVP	PV over-voltage	Check whether the PV series voltage (Voc) is higher than the maximum input voltage of the inverter. If so, adjust the number of PV modules in series and reduce the PV series voltage to fit the input voltage range of the inverter. After correction, the inverter will automatically return to its normal state.
ID070	BatOVP	Battery over-voltage	Check whether the battery overvoltage setting is inconsistent with the battery specification.
ID071	LLCBusOVP	LLC BUS overvoltage protection	Internal faults of inverter, switch OFF inverter, wait for 5 minutes, then switch ON inverter. Check whether the problem is solved. If no, please contact technical support.
ID072	SwBusRmsOVP	Inverter bus voltage RMS software overvoltage	
ID073	SwBusInstantOVP	Inverter bus voltage instantaneous value software overvoltage	
ID081	SwBatOCP	Battery overcurrent software protection	
ID082	DciOCP	Dci overcurrent protection	
ID083	SwOCPInstant	Output instantaneous current protection	
ID084	SwBuckBoostOCP	BuckBoost software flow	
ID085	SwAcRmsOCP	Output effective value current protection	
ID086	SwPvOCPInstant	PV overcurrent software protection	

ID087	IpvUnbalance	PV flows in uneven parallel	
ID088	IacUnbalance	Unbalanced output current	
ID097	HwLLCBusOVP	LLC bus hardware overvoltage	
ID098	HwBusOVP	Inverter bus hardware overvoltage	
ID099	HwBuckBoostOCP	BuckBoosthardware overflows	
ID100	HwBatOCP	Battery hardware overflows	
ID102	HwPVOCP	PV hardware overflows	
ID103	HwACOCP	Ac output hardware overflows	
ID110	Overload1	Overload protection 1	
ID111	Overload2	Overload protection 2	
ID112	Overload3	Overload protection 3	Please check whether the inverter is operating under overload.
ID113	OverTempDerating	Internal temperature is too high.	Make sure the inverter is installed where there is no direct sunlight. Please ensure that the inverter is installed in a cool/well ventilated place. Ensure the inverter is installed vertically and the ambient temperature is below the inverter temperature limit.
ID114	FreqDerating	AC frequency is too high	Please make sure the grid frequency and voltage is within the acceptable range.
ID115	FreqLoading	AC frequency is too low	
ID116	VoltDerating	AC voltage is too high	
ID117	VoltLoading	AC voltage is too low	
ID124	BatLowVoltageAlarm	Battery low voltage protection	Please check whether the battery voltage of the inverter is too low.
ID125	BatLowVoltageShut	Battery low voltage shutdown	
ID129	unrecoverHwAcOCP	Output hardware overcurrent permanent failure	Internal faults of inverter, switch OFF inverter, wait for 5 minutes, then switch ON inverter. Check whether the problem is solved. If no, please contact technical support.
ID130	unrecoverBusOVP	Permanent Bus overvoltage failure	
ID131	unrecoverHwBusOVP	Permanent Bus hardware overvoltage failure	
ID132	unrecoverIpvUnbalance	PV uneven flow permanent failure	
ID133	unrecoverEPSBatOCP	Permanent battery overcurrent failure in	

		EPS mode	
ID134	unrecoverAcOCP Instant	Output transient overcurrent permanent failure	
ID135	unrecoverIacUnbalance	Permanent failure of unbalanced output current	
ID137	unrecoverPvConfigError	Input mode setting error permanent failure	Check the PV input mode (parallel/independent mode) Settings for the inverter. If not, change the PV input mode.
ID138	unrecoverPVOCP Instant	Input overcurrent permanent fault	
ID139	unrecoverHwPV OCP	Input hardware overcurrent permanent failure	Internal faults of inverter, switch OFF inverter, wait for 5 minutes, then switch ON inverter. Check whether the problem is solved. If no, please contact technical support.
ID140	unrecoverRelayFail	Permanent relay failure	
ID141	unrecoverVbusUnbalance	Bus voltage unbalanced permanent failure	
ID145	USB Fault	USB fault	
ID146	Wifi Fault	Wifi fault	Check the Wifi port of the inverter
ID147	Bluetooth Fault	Bluetooth fault	Check the bluetooth connection of the inverter
ID148	RTCFault	RTC clock failure	
ID149	CommEEPROM Fault	Communication board EEPROM error	Internal faults of inverter, switch OFF inverter, wait for 5 minutes, then switch ON inverter. Check whether the problem is solved. If no, please contact technical support.
ID150	Flash Fault	Communication board FLASH error	
ID153	SciCommLose(DC)	SCI communication error (DC)	
ID154	SciCommLose(AC)	SCI communication error (AC)	
ID155	SciCommLose(Fuse)	SCI communication error (Fuse)	
ID156	SoftVerError	Inconsistent software versions	Contact for technical support and software upgrades.
ID157	BMSCommunicationFault	Communication failure of lithium battery	Make sure your battery is compatible with the inverter. CAN communication is recommended. Check the communication line or port of the battery and inverter for faults.
ID161	ForceShutdown	Force shutdown	The inverter is performed a forced shutdown
ID162	RemoteShutdown	Remote shutdown	The inverter is performed a remote shutdown.
ID163	Drms0Shutdown	Drms0 shutdown	The inverter is performed with a Drms0 shutdown.
ID165	RemoteDerating	Remote derating	The inverter is performed for remote load reduction.

ID166	LogicInterfaceDerating	Logic interface derating	The inverter is loaded by the execution logic interface.
ID167	AlarmAntiRefluxing	Anti refluxderating	The inverter is implemented to prevent countercurrent load drop.
ID169	FanFault1	Fan 1 fault	Please check whether the fan 1 of inverter is running normally.
ID170	FanFault2	Fan 2 fault	Please check whether the fan 2 of inverter is running normally.
ID171	FanFault3	Fan 3 fault	Please check whether the fan 3 of inverter is running normally.
ID172	FanFault4	Fan 4 fault	Please check whether the fan 4 of inverter is running normally.
ID173	FanFault5	Fan 5 fault	Please check whether the fan 5 of inverter is running normally.
ID174	FanFault6	Fan 6 fault	Please check whether the fan 6 of inverter is running normally.
ID177	BMS OVP	BMS over-voltage alarm	Internal failure of lithium battery, close inverter and lithium battery, and wait 5 minutes to open inverter and lithium battery. Check that the problem is resolved. If not, please contact technical support.
ID178	BMS UVP	BMS under-voltage alarm	
ID179	BMS OTP	BMS high temperature warning	
ID180	BMS UTP	BMS low temperature alarm	
ID181	BMS OCP	Warning of overload in charge and discharge of BMS	
ID182	BMS Short	BMS short circuit alarm	

Maintenance

Inverters generally do not need any daily or routine maintenance. Heat sink should not be blocked by dust, dirt or any other items. Before the cleaning, make sure that the DC SWITCH is turned OFF and the circuit breaker between inverter and electrical grid is turned OFF. Wait at least for 5 minutes before the Cleaning.

❖ Inverter cleaning

Please clean the inverter with an air blower, a dry & soft cloth or a soft bristle brush. Do NOT clean the inverter with water, corrosive chemicals, detergent, etc.

❖ Heat sink cleaning

For the long-term proper operation of inverters, ensure there is enough space around the heat sink for ventilation, check the heat sink for blockage (dust, snow, etc.) and clean them if they exist. Please clean the heat sink with an air blower, a dry & soft cloth or a soft bristle brush. Do NOT clean the heat sink with water,

corrosive chemicals, detergent, etc.

9. Technical Data

Battery Parameters.

Datasheet	HYD 5KTL - 3PH	HYD 6KTL- 3PH	HYD 8KTL- 3PH	HYD 10KTL -3PH	*HYD 10KTL -3PH- A	HYD 15KTL -3PH	HYD 20KTL -3PH
Battery type	Li-Ion						
No. of battery input	1			2			
Battery voltage range	180V-800V						
Nominal battery voltage	450Vdc						
Battery voltage range for full load(V)	200-800	240-800	320-800	200-800	200-800	300-800	400-800
Nominal. charging/discharging power(W)	5000	6000	8000	10000	10000	15000	20000
Max. charging/discharging current	25A			50A(25A/25A)			
Peak charging/discharging current, Duration	40A, 60s			70A(35A/35A), 60s			
Charging strategy	Follow BMS						
Battery capacity	25Ah~100Ah						
Communicati on interfaces	CAN(RS485)						

PV String Input Data

Datasheet	HYD 5KTL-3PH	HYD 6KTL-3PH	HYD 8KTL-3PH	HYD 10KTL-3PH	*HYD 10KTL-3PH-A	HYD 15KTL-3PH	HYD 20KTL-3PH
Recommended Max.PV power	7500(6000/6000)	9000(6600/6600)	12000(6600/6600)	15000(7500/7500)	15000(7500/7500)	22500(11250/1250)	30000(15000/15000)
Max DC voltage	1000V						
Start-up voltage	200V						
MPPT voltage range	180-960V						
Rated DC voltage	600V						
No. of MPP trackers	2						
Max inverter backfeed current to array	0A						
No. of strings per MPP tracker	1			2			
Full power MPPT voltage range(V)	250-850	320-850	360-850	220-850	220-850	350-850	450-850
Max. Input current	12.5A/12.5A			25A/25A			
Max short-circuit current	15A/15A			30A/30A			

AC Output Data (ON-Grid)

Datasheet	HYD 5KTL-3PH	HYD 6KTL-3PH	HYD 8KTL-3PH	HYD 10KTL-3PH	*HYD 10KTL-3PH-A	HYD 15KTL-3PH	HYD 20KTL-3PH
Nominal AC power(W)	5000	6000	8000	10000	10000	15000	20000
Rated apparent power(VA)	5000	6000	8000	10000	10000	15000	20000
Max. AC power output to utility grid(VA)	5500	6600	8800	11000	10000	16500	22000
Max. AC power from utility grid(VA)	10000	12000	16000	20000	20000	30000	40000
Max. AC current output to utility grid	8A	10A	13A	16A	16A	24A	32A
Max. AC Current from utility grid	15A	17A	24A	29A	29A	44A	58A
Output Inrush current	100A/1 μ s						
Output fault current	80A/5 μ s						
Output overcurrent protection (RMS)	10A	12A	15A	18A	18A	26A	34A
Output overcurrent protection (MAX)	20.4A	22.5A	33.1A	40.7A	40.7A	61.1A	81.5A
Nominal grid voltage	3/N/PE, 220/380Vac, 230/400Vac						
Grid voltage range	184Vac~276Vac						
Nominal grid frequency	50Hz/60Hz						
Grid frequency range	45Hz~55Hz/55Hz~65Hz						
Output power factor	1 (0.8 leading to 0.8 lagging)						
Output THDi (@Nominal output)	<3%						

AC Output Data (Off-Grid)

Datasheet	HYD 5KTL- 3PH	HYD 6KTL- 3PH	HYD 8KTL- 3PH	HYD 10KTL -3PH	*HYD 10KTL -3PH- A	HYD 15KTL -3PH	HYD 20KTL -3PH
Nominal output power(W)	5000	6000	8000	10000	10000	15000	20000
Max. output power(VA)	5500	6600	8800	11000	10000	16500	22000
Peak output power, Duration	10000V A,60s	12000V A,60s	16000V A,60s	20000V A,60s	20000V A,60s	22000V A,60s	22000V A,60s
Max. output current	8A	10A	13A	16A	16A	24A	32A
Peak output current, Duration	15A,60s	18A,60s	24A,60s	30A,60s	30A,60s	32A,60s	32A,60s
Nominal output voltage	3/N/PE, 220/380Vac, 230/400Vac						
Nominal output frequency	50/60Hz						
Output THDv (@Liner load)	<3%						
Switch time	<10ms						

Efficiency And Protection

Datasheet	HYD 5KTL-3PH	HYD 6KTL-3PH	HYD 8KTL-3PH	HYD 10KTL-3PH	*HYD 10KT L-3PH -A	HYD 15KTL-3PH	HYD 20KTL-3PH
MPPT efficiency	99.9%						
Euro efficiency	97.5%	97.5%	97.5%	97.7%	97.7%	97.7%	97.7%
Max. efficiency	98.0%	98.0%	98.0%	98.2%	98.2%	98.2%	98.2%
Max. battery charge/discharge efficiency	97.6%	97.6%	97.6%	97.8%	97.8%	97.8%	97.8%
DC switch	Yes						
PV reverse polarity protection	Yes						
Output over current protection	Yes						
Output over voltage protection	Yes						
Anti-islanding protection	Yes						
Residual current detection	Yes						
Insulation resistor detection	Yes						
Surge protection level	II						
Battery reverse protection	Yes						

General Data

Datasheet	HYD 5KTL-3PH	HYD 6KTL-3PH	HYD 8KTL-3PH	HYD 10KTL-3PH	*HYD 10KTL-3PH-A	HYD 15KTL-3PH	HYD 20KTL-3PH
Dimension	586.6mm*515mm*261.2mm						
Weight	33kg			37kg			
Inverter topology	Non-Isolation						
Over voltage category	AC: Type III DC: Type II						
Active anti-islanding method	ROCOF						
Standby self consumption	<15W						
Operating temperature range	-30°C~60°C						
Relative humidity	0~100%						
Noise	<45dB						
Operating altitude	<2000m						
Cooling	Natural			Forced airflow			
Protection degree	IP65						

Feature And Standard

Datasheet	HYD 5KTL- 3PH	HYD 6KTL- 3PH	HYD 8KTL- 3PH	HYD 10KTL -3PH	*HYD 10KT L-3PH -A	HYD 15KTL -3PH	HYD 20KTL -3PH
DC terminal	MC4						
Grid AC terminal	5P Connector						
Back-up AC terminal	5P Connector						
Display	LCD Display						
Monitoring interfaces	Bluetooth / RS485 / WIFI / GPRS (optional)						
Parallel operation	Yes						
Standard warranty	10 years						
Grid	AS/NZS 4777, VDE V 0124-100, V0126-1-1, VDE-AR-N 4105, CEI 0-21/CEI 0-16, EN50438/EN50549, G83/G59/G98/G99, UTE C15-712-1, UNE206 007-1						
Safety	IEC62109-1, IEC62109-2, NB-T32004/IEC62040-1						
EMC	EN61000-1, EN61000-2, EN61000-3, EN61000-4, EN61000-4-16, EN61000-4-18, EN61000-4-29						

10. *Quality Assurance*

SOFARSOLAR *Factory's Warranty Terms and Conditions for Australia

Applicable products

These *Factory's Warranty Terms and Conditions (“Terms and Conditions”) only applies to the following products, which are distributed and installed in Australia.

Table

Product	Standard warranty period (months)
Inverter	
GRID-TIED (HYD 5-20KTL-3PH)	120
Accessories	
CT Clamp	24
smart Meter	24
WIFI dongle	24

This factory warranty is a promise from SOFARSOLAR to its end users on the applicable products listed above.

Definitions

In these Terms and Conditions:

- a) “ACL” means Schedule 2 to the Competition and Consumer Act 2010 (Cth);

- b) “Claim” means any judgment, claim, demand, action, suit or proceeding for damages, debt, restitution, equitable compensation, account, injunctive relief, specific performance or any other remedy, whether by original claim, cross claim or otherwise whether arising at common law, in equity, under statute or otherwise wherever arising, whether known or unknown at the time of these Terms and Conditions, whether presently in contemplation of the parties or not;

- c) “Consequential Loss” means loss or damage, whether direct or indirect, in the nature of, among other things, loss of profits, loss of revenue, loss of production, liabilities in respect of third parties (whether contractual or not), loss of anticipated

savings or business, pure economic loss, loss of opportunity and any form of consequential, special, indirect, punitive or exemplary loss or damages, whether or not a party was advised of the possibility of such loss or damage;

d) "End User" means a person or entity whose order for the purchase of the Product is accepted by SOFARSOLAR;

e) "Loss" means, in relation to any person, any damage, loss, cost, expense or liability incurred by the person or arising from any Claim, action, proceedings or demand made against the person, however arising and whether present or future, fixed or ascertained, actual or contingent and includes Consequential loss;

f) "Product" means any applicable product or products distributed and installed by SOFARSOLAR to the End User as set out in the Table of these Terms and Conditions;

g) "Warranty Period" means the applicable warranty period of the relevant Product as stipulated in the Table of these Terms and Conditions.

Warranty Conditions

Our goods come with guarantees that cannot be excluded under the ACL. You are entitled to a replacement or refund for a major failure and for compensation for any other reasonably foreseeable loss or damage. You are also entitled to have the goods repaired or replaced if goods fail to be of acceptable quality and the failure does not amount to a major failure. Subject to any statutory rights which cannot be excluded (including the ACL) and the terms of any warranty stipulated in these Terms and Conditions, the End User acknowledges that:

prior to purchasing the Product, the End User conducted a thorough examination of the Product;

b) SOFARSOLAR made no warranty, condition, description, or representation in relation to the Product outside those contained in these Terms and Conditions;

c) all warranties, conditions, guarantees, and terms in relation to the state, quality or fitness of the Product and of every other kind whether expressed or implied by use, statute or otherwise are excluded.

To the fullest extent that SOFARSOLAR is able to limit the remedies available

under these Terms and Conditions, SOFARSOLAR expressly limits its liability for any breach of a condition or warranty implied by virtue of any applicable legislation (including the ACL) to the following remedies in the event SOFARSOLAR decides a Product to be faulty or otherwise defective during the Warranty Period (or otherwise):

- a) The repair of the Product by SOFARSOLAR whether on-site or off-site;
- b) The replacement of the Product;
- c) The payment of the costs of having the Product repaired.

The payment of the costs of replacing the Product or acquiring equivalent goods. If the Product needs to be replaced, the balance of the Factor's Warranty Period will be applied and transferred to the replacement Product and will continue until its expiry. In this event, the End User will not receive any new warranty card or be entitled to a further Warranty Period, and the replacement Product(s) will be registered by SOFARSOLAR.

Unless otherwise agreed in writing by the parties, the Factory warranty exclusively covers the cost of one (1) freight to the End User, labour and material necessary to regain a faultless functioning Product. The Factory warranty does not cover, without limitation, Consequential Loss, repair reimbursement costs, transport costs, travel costs, accommodation cost of SOFARSOLAR personnel as well as any costs of associated third party staff and personnel. Express delivery costs will not be covered.

In the event SOFARSOLAR, in its sole discretion, decides that any faulty or otherwise defective Product will be repaired on-site or otherwise replaced, in some service areas or business cases, to encourage the End User using the installer's facilities to receive a faultless and functioning product, SOFARSOLAR may, in its sole discretion, offer a rebate to the End User or local installer/electrician to cover the on-site service labour under the following conditions:

The rebate will be eligible ONLY to the party who has carried out on-site service for the purported faulty or otherwise defective Product;

The purported faulty or otherwise defective Product has been returned in the original replacement product packaging to SOFARSOLAR and deemed to have

workmanship or material defects upon testing and inspection by SOFARSOLAR. If the purported faulty or otherwise defective Product is deemed free of faults and defects that would qualify a replacement under these Terms and Conditions, then SOFARSOLAR is entitled to charge a retail price of the Product(s), shipping and packaging and any associated labour cost in replacing the purported faulty or otherwise defective Product;

SOFARSOLAR must be contacted prior to the site visit for authorisation. If the site is not located in a metropolitan area in Australia or if the installer is unable to be on-site, the End User must engage their own electrician to carry out and complete the on-site service;

The service rebate must be claimed strictly within two (2) months of the date upon which the on-site service is authorised by SOFARSOLAR.

SOFARSOLAR retains the right to arrange the warranty service for the End User and to use third parties for performing any warranty services. SOFARSOLAR retains full title and ownership of the supplied replacement Product(s) until the purported faulty or otherwise defective Product has been received in accordance with these terms and conditions.

The End User may contact the dealer (SOFARSOLAR authorised dealer or distributor) or installer if the Product is faulty or otherwise defective.

All other purported costs including, but not limited to, compensation from any direct or indirect Loss arising from the faulty or otherwise defective Product or other facilities of the PV system, or loss of electrical power generated during the product downtime are NOT covered by the SOFARSOLAR limited warranty.

Scope of the Warranty

The warranty stipulated in these Terms and Conditions will not apply if SOFARSOLAR, in its sole discretion, decides that any one (1) of the following occurs:

The End user is in default under the General Terms and Conditions of other agreement governing the purchase of the Product, or

Any damage or defect to the Product is caused any one (1) or more of the following

situations (the Dealers or Distributors are responsible and authorized by SOFARSOLAR for the following investigation):

Disassembly, attempted repair or modifications performed by any person not authorised by SOFARSOLAR in writing, or serial number or seals have been removed. Product modifications, design changes or part replacements without prior written approval of SOFARSOLAR;

The End user or installer has failed, refused or otherwise neglected to comply with the applicable safety regulations (IE, VDE standards or equivalent) governing the proper use of the Product in force from time to time;

The Product has been improperly stored and damaged by the dealer, distributor or the End User;

The fault or otherwise defect is damage sustained during transportation (including painting scratch caused by movement inside packaging during shipping). A Claim for such transport damage should be made directly to the shipping company/insurance company as soon as the container/packaging is unloaded and such damage is identified;

The Product has been used and installed by an unauthorised or unlicensed installer who fails, refuses, or otherwise neglects to strictly follow any applicable user manual, installation guide and maintenance regulations supplied with the Product, including not ensuring sufficient ventilation for the Product as described in SOFARSOLAR installation guide;

Defects, faults, cosmetics or rendered non-functional damage caused by unforeseen circumstances, or force majeure event including, but not limited to, any vandalism, violent or stormy weather, lightning, flooding, power fluctuation, overvoltage, grid power surge, pests, fire damage, wind damage, or exposure to erosion, sea coasts/saltwater or other aggressive atmospheres or environmental conditions;

Use of the Product in combination with any unauthorised products, equipment or materials as per the user manual, installation guide and maintenance regulations supplied with the Product;

Combining the Product with any other lithium battery pack that is not listed on any SOFARSOLAR's battery compatibility list from time to time.

Limitation of Liability

a) This limited warranty supersedes and otherwise replaces any different SOFARSOLAR warranties and liabilities, whether oral, in writing, (non-obligatory) statutory, contractual, in tort or otherwise, consisting of, without quandary, and where permitted by using relevant law, any implied conditions, warranties or different phrases as regards exemplary quality or fitness for purpose. However, this limited warranty shall neither exclude nor limit any of your legal (statutory) rights provided under the relevant national laws and regulations.

b) Subject to clauses 4(c) and (d):

i. all warranties, descriptions, representations, guarantees or conditions, whether express or implied by law, trade, custom or otherwise, and all specific conditions, even though such conditions may be known to SOFARSOLAR, are, to the fullest extent, expressly excluded;

ii. SOFARSOLAR is not liable for any delay or Loss arising from the supply of or failure to supply the Product or comply with an order of the End User whether due to shortfall, defect, incorrect delivery or otherwise for any reason whatsoever including breach of contract (including fundamental breach), negligence, breach of duty as bailee, or the wilful act or default of SOFARSOLAR.

c) These Terms and Conditions shall not exclude or limit the application of any provisions of any statute including any implied condition or warranty the exclusion of which would contravene any statute (including the ACL) or cause any part of this clause 4 to be illegal, invalid, void or unenforceable.

d) If the exclusion of liability in clause 4(b) is reduced, void or not available, SOFARSOLAR's liability for any Claims arising out of these Terms and Conditions, including liability for breach of these Terms and Conditions, in negligence or in tort or for any other common law or statutory action, shall:

i. be limited to the extent the Loss the subject of the Claim was caused directly by SOFARSOLAR; and

ii. in all events, exclude Loss relating to any delay in supply of the Product and for any Consequential Loss.

e) SOFARSOLAR guarantees the performance of the Product under the normal working conditions within the standard warranty term and provide limited technical support if applicable. However, SOFARSOLAR shall assume no liability for system malfunctions and any incurred loss or damages whatsoever.

Please refer to SOFARSOLAR Energy Storage Warranty Terms and Conditions for further information on SOFARSOLAR Energy Storage products.

Procedure for Claiming a Warranty

In the case of a faulty or otherwise defective Product please report that Product within the agreed warranty period, with a detailed error description to SOFARSOLAR's service hotline for registering and send the claim to SOFARSOLAR service department by fax/email or through SOFARSOLAR Warranty Claim Website at <https://service.sofarsolar.com/warranty/search> to process the warranty claim. The End User may also contact the dealer (SOFARSOLAR authorised dealer or distributor) or installer if the Product is defective or faulty.

To make a claim under the warranty, the End User must provide the following information and documentation of the faulty or otherwise defective Product:

Product Model and serial number

A copy of the valid purchasing invoice

Fault descriptions and error IDs (where applicable)

End user and/or claimant details

Detailed information about the entire system (module, PV system diagram, installation date, etc.)

Documentation of previous claims/exchanges (if applicable)

The warranty may not be guaranteed if the above information is not provided.

Extension of the Warranty Period

For SOFARSOLAR inverters, the End User may apply for a Warranty Period extension within 24 months for grid-tied inverter <50kW and 12 months for grid-tied ≥ 50 kW and energy storage inverter(hybrid) inverters from the date of production from SOFARSOLAR by providing the serial number and copy of the warranty card of the Product. SOFARSOLAR may reject any application received which does not meet the date requirement. An extended Warranty Period can be purchased to 10, 15, or 20 years. Please refer to the Warranty Extension Order Form for more information.

Once the purchase of the Warranty Period extension has been processed, SOFARSOLAR will send a Warranty Period extension certificate to the End User confirming the extended Warranty Period.

Any faults or defects that occur after the expiry of the Warranty Period, or which occur within the Warranty Period but which are listed in the warranty exceptions above, are deemed to be out-of-warranty cases. For all out-of-warranty cases, SOFARSOLAR, in its sole discretion, may charge fees to the End User including, without limitation:

- a) On-site service fee: cost of travel and time for the technician to deliver on-site service and labour cost for the technician, who is repairing, performing maintenance on, installing (hardware or software) and debugging the faulty product.
- b) Parts/materials fee: cost of replacement parts/materials (including any shipping/admin fee that may apply).
- c) Logistics fee: cost of delivery and any other expenses incurred when defective products are sent from the user to SOFARSOLAR or/and repaired products are sent from SOFARSOLAR to the user.

Latest information about the warranty terms and conditions and local service hotline can be obtained from our website: www.sofarsolar.com.au

Our goods come with guarantees that cannot be excluded under the Australian

Consumer Law. You are entitled to a replacement or refund for a major failure and compensation for any other reasonably foreseeable loss or damage. You are also entitled to have the goods repaired or replaced if the goods fail to be of acceptable quality and the failure does not amount to a major failure.

Contact us

You can directly contact our professional after-sales team:

Sofarsolar Ausco Pty Ltd.

Tel: +61 401 734 463 / 408 500 386

Shenzhen Sofarsolar Co. Ltd.



Product Name: Energy storage integrated inverter

Company Name: Shenzhen SOFARSOLAR Co., Ltd.

ADD: 11/F., Gaoxingqi Technology Building, No.67 Area, Xingdong Community, Xin'an Sub-district,
Bao'an District, Shenzhen City,China

Email: service@sofarsolar.com

Tel: 0510-6690 2300

Web: www.sofarsolar.com



301.00000265-1