

# HEC2-BHP SERIES OPERATING MANUAL

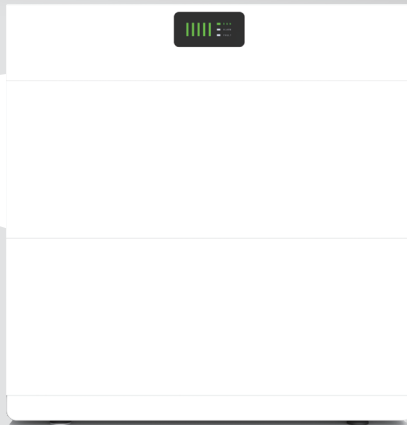

## EXCLUSION OF LIABILITY

All names, trademarks, product names or other designations used in this manual may be legally protected even if not indicated as such (e.g. as a trademark). **HICONICS ECO-ENERGY DRIVE TECHNOLOGY CO., LTD.** assumes no liability or warranty for their free usage. The illustrations and texts have been compiled with great care. However, the possibility of errors cannot be ruled out. The compilation is made without any guarantee.

## GENERAL NOTE ON GENDER EQUALITY

HICONICS ECO-ENERGY DRIVE TECHNOLOGY CO., LTD. is aware of the importance of language with regard to the equality of women and men and always makes an effort to reflect this in the documentation. Nevertheless, for the sake of readability we are unable to use non-gender-specific terms throughout and use the masculine form instead.

© 2023 HICONICS ECO-ENERGY DRIVE TECHNOLOGY CO., LTD.

All rights reserved by HICONICS ECO-ENERGY DRIVE TECHNOLOGY, including those of reproduction by photocopy and storage in electronic media. Commercial use or distribution of the texts, displayed models, diagrams and photographs appearing in this product is not permitted. This manual may not be reproduced, stored, transmitted or translated in any form or by means of any medium, in whole or in part, without prior written permission.

# CONTENTS

<b>1 Introduction</b> .....	01
1.1 Product introduction.....	01
1.2 Target Group.....	03
1.3 Information about safety.....	03
1.4 Battery safety specification.....	08
1.5 General precautions.....	08
1.6 List of installation accessories.....	09
1.7 Limitation of liabilities.....	10
<b>2 Installation</b> .....	11
2.1 Installation site and environment.....	11
2.2 Installation.....	13
2.3 Communication connection.....	18
2.4 Cable connection.....	19
<b>3 System operation</b> .....	21
3.1 Start.....	21
3.2 Turn off.....	21
3.3 Emergency procedure.....	21
<b>4 Battery status description</b> .....	23
4.1 Panel description.....	23
<b>5. Battery storage and recharging</b> .....	26
5.1 Battery storage requirements.....	26
5.2 Storage expiration.....	27
5.3 Inspection before battery recharging.....	28
5.4 Recharge Operation Steps.....	28
<b>6. Battery port definition and parameters</b> .....	29
6.1 Port definition.....	29
6.2 Battery parameters.....	32
<b>7. Routine maintenance</b> .....	33
7.1 Maintenance plan.....	33
7.2 Cautions.....	34
<b>8. Fault codes and solutions</b> .....	34
<b>9. Quality commitments</b> .....	38

# 1 Introduction

## 1.1 Product introduction

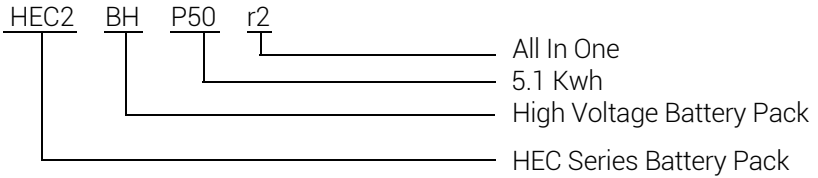

HEC2-BHP50r2 can be used in conjunction with inverters and can store and release electrical energy according to the requirements of the inverters.

Configuration	
HEC2-BHP50r2	Base+BMS+1*PACK
HEC2-BHP100r2	Base+BMS+2* PACK
HEC2-BHP150r2	Base+BMS+3* PACK
HEC2-BHP200r2	Base+BMS+4* PACK
HEC2-BHP200r2-A	2*(Base+BMS+2* PACK)
HEC2-BHP300r2	2*(Base+BMS+3* PACK)
HEC2-BHP400r2	2*(Base+BMS+4* PACK)

**Note:** Hiconics brand battery packs are only compatible with Hiconics brand inverters, Compatible inverters are listed as below

Brand	Inverter Model
Hiconics	HEC2-S3.8Hr2
Hiconics	HEC2-S5.0Hr2
Hiconics	HEC2-S6.0Hr2
Hiconics	HEC2-T8.0Hr2
Hiconics	HEC2-T10.0Hr2
Hiconics	HEC2-T12.0Hr2
Hiconics	HEC2-T15.0Hr2

## Electrical circuit diagram

There is a breaker in the BMS main box, which can isolate all live (active and neutral) conductors as shown in figure below.

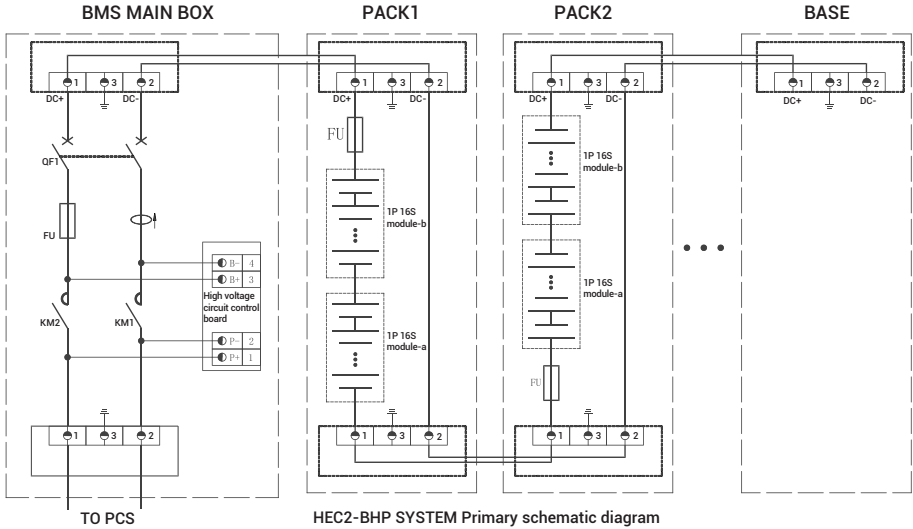

## Storage capacity description

The capacity of battery packs can be increased by connecting them in series or parallel, as shown in the following.



2~4 battery packs in series

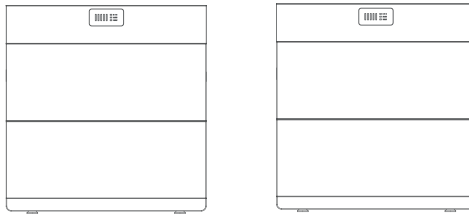

*Two sets in parallel/Two packs in series of each set*



*Two sets in parallel / three or four packs in series of each set*

## 1.2 Target Group

This manual is for qualified electricians. The tasks described in this manual only can be performed by qualified electricians.

## 1.3 Information about safety







### Manual preservation

This manual contains important information about equipment operations. Please read it carefully before any operation and carry out the operations strictly according to the instructions in the manual. Otherwise, it will cause equipment warning signs, personnel and property damage or loss. Be sure to keep this manual for maintenance and repair.

## Operator requirements

The operator should have professional qualifications or be trained. The operator should be familiar with the composition and operating principle of the whole storage system including equipment. The operator should be familiar with the product manual. During maintenance, the maintenance personnel should not operate any equipment until all equipment is turned off and the power is switched off.

## Symbols on the Type Label

Symbol	Explanation
	CE mark. The inverter complies with the requirements of the applicable CE
	TUV mark
	The battery should be recycled environmentally and safely in proper facilities.
	Danger to life due to high voltages in the inverter!
	Danger Risk of electric shock!
	Observe enclosed documentation
	Do not dispose of the system together with the household waste but in accordance with the disposal regulations for electronic waste applicable at the installation site



Keep the battery modules away from open flame or ignition sources.

## Warning signs

The warning signs contain important information for safe operation and shall not be torn or broken. Make sure that the warning signs are always placed properly. The broken sign must be replaced immediately



**Danger!**

Extremely dangerous situation leading to certain death or serious injury if the safety information is not observed.



**Warning!**

Dangerous situation leading to potential death or serious injury if the safety information is not observed.



**Caution**

Dangerous situation leading to potential injury if the safety information is not observed.



**Notice**

Indicates actions that may cause material damage.

## Important Safety Instructions



**Danger!**

Danger!

Danger to life due to high voltages in the inverter! All work must be carried out by qualified electrician

The appliance is not to be used by children or persons with reduced physical sensory or mental capabilities, or lack of experience and knowledge, unless they have been given supervision or instruction.





**Caution**

Caution!

Danger of burn injuries due to hot enclosure parts!  
During operation, the upper of the enclosure and the enclosure body may become hot.  
Only touch the lower enclosure lid during operation.

---



**Caution**

Caution!

Possible damage to health as result of the radiation!  
Do not stay closer than 20cm to inverter for any length of time.

---



**Notice**

Notice!

Grounding the PV generator.  
Comply with the local requirements for grounding the PV modules and the PV generator. It is recommends connecting the generator frame and other electrically conductive surfaces in a manner which ensures continuous conduction and ground these in order to have optimal protection of system and persons.

---



**Warning!**

Warning!

Risk of electric shock!

---



**Warning!**

Warning!

Ensure input DC voltage  $\leq$ Max. DC voltage. Over voltage may cause permanent damage to system or other losses, which will not be included in warranty!

---



**Warning!**

Warning!

Authorized service personnel must disconnect both AC and DC power from system before attempting any maintenance or cleaning or working on any circuits connected to system

---



**Warning!**

Warning!

Do not operate the system when the device is running.

---

## Setting of safety warning signs

- During guidance, maintenance and repair, please follow the instructions below to avoid non-professionals' misuse or accidents caused by non-professionals:
- Conspicuous signs should be placed at the front and rear switches to avoid accidents caused by mistake operation.
- A warning sign or cordon should be set near the operating area.
- The system must be reinstalled after maintenance or operation.

## Measuring equipment

In order to ensure that the electrical parameters meet the requirements, relevant measuring equipment is required when the system is connected or tested. Make sure that equipment of matching specifications is connected and used in case arcs or shocks occur.

## Moisture protection

Moisture is likely to damage the battery. For repair or maintenance, avoid or prevent operations in humid weather.

## Operations after power-down

The battery system is part of the energy storage system, which can store life-threatening high voltages even when the direct current is turned off. Do not touch the battery socket. Even after the direct current or alternating current is cut off, the battery PACK can still maintain a life-threatening voltage. Therefore, for safety's sake, be sure to test the voltage with a calibrated voltage meter before the installation personnel operates the equipment.

## Dispose and recycle

Dispose and recycle batteries properly according to the management rules of waste batteries in different countries.

## 1.4 Battery safety specification

### Information about dangers

This product is a lithium iron phosphate battery, which meets the requirements of the UN's recommendations for the transportation of dangerous goods, tests and the UN38.3 certification. For batteries, chemical substances are stored in a sealed metal box designed to withstand the temperature and pressure encountered during normal use. Therefore, there is no physical danger of fire and explosion and chemical danger of hazardous goods leakage during normal use. However, if the product is exposed to any fire, mechanical shock, or electrical stress arising from misuse or is decomposed, the gas release port will be activated. The casing of the battery box will be broken to the limit, and harmful substances may be released.

### Safety data table

For more information, please refer to the battery safety data table

## 1.5 General precautions



### Warning!



There is a danger of chemical burns from the electrolyte or toxic gases. During normal operations, there will be no electrolyte leakage in the battery PACK and no toxic gases. If the battery PACK is damaged or malfunctions, there may be electrolyte leakage or toxic gases.

- Do not touch the battery with wet hands.
- Do not install or operate the battery in a potentially explosive environment or highly humid area.
- If moisture permeates the battery (e.g., due to the broken casing), do not install or operate the battery.
- Do not move the equipment that has been connected to a battery module. Fix the equipment in case it will tilt.
- The battery PACK must be transported by the manufacturer or designated personnel. The notes should be recorded and filed.

- A certified ABC fire extinguisher with a minimum capacity of 2 kg must be carried during transportation.
- During loading and unloading, do not smoke in and near the vehicle.
- If necessary, when replacing a battery module, please request new dangerous goods PACKaging and then PACKage it before handing it over to the supplier for collection.
- In the event of contact with the electrolyte, please carry out a rinse with clean water and then seek medical attention immediately.
- There is a risk of injury when lifting or dropping the equipment. The battery PACK is heavy. There is a risk of injury if the inverter or battery is improperly lifted or dropped when transported or attached to or removed from the wall.
- The battery PACK must be lifted or handled by more than 2 persons.

### 1.6 List of installation accessories

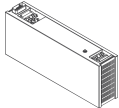
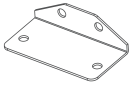
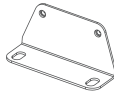
Check the parts list below to ensure that the accessories are complete.( Taking the installation of two battery packs as an example)

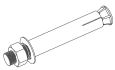
2x(Battery packing list)				
				
Battery pack	2x Mounting bracket	2x Battery bracket	M 5 *14 (8 PCS)	M 8 *60(4 PCS)

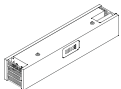
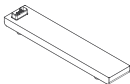
BMS Control box & base				
				
1xBMS control box	1x base			

## 1.7 Limitation of liabilities

No direct or indirect responsibility will be assumed for product damage or property loss caused by the following situations:

- product modification, design alteration or parts replacement unauthorized by HICONICS;
- the serial number or seal is changed, modified or erased by non-technical personnel;
- failure to comply with local safety regulations (DE: VDE; AU: SAA);
- there is damage during transportation (including paint scratches caused by friction inside the PACKaging during transportation), where after the container/PACKage is unloaded and the damage is confirmed, a claim should be lodged immediately with the shipping or insurance company;
- failure to comply with any/all user manuals, installation guides and maintenance rules;
- improper or misuse of equipment;
- inadequate ventilation of equipment;
- failure to carry out maintenance in accordance with the standard maintenance procedure;
- force majeure (storms, lightning, fire, etc.);
- any damage caused by external factors.

## 2 Installation

### 2.1 Installation site and environment

#### General rules

Installation is not allowed in the following locations:

1. residential rooms;
2. holes in ceilings or walls;
3. the roof that is not particularly suitable;
4. an entrance/exit area or below a staircase/passageway;
5. locations where humidity and condensed water exceed 90%;
6. places that salty and humid air can permeate;
7. earthquake zones where additional safety measures are required;
8. a site at an altitude of more than 2000 meters;
9. places with explosive environments;
10. a place exposed to direct Sunlight/rain or a place where the ambient
11. places with flammable materials or gases or explosive environments.

#### Restricted locations

Do not install the battery PACK series battery PACK in the following locations:

- (a) the restricted position determined for the panel in the as/NZS 3000;
- (b) no more than 600mm from any heat source (such as hot water heater unit, gas-fueled heater, air conditioning unit or any other equipment);
- (c) no more than 600mm from any exit;
- (d) no more than 600mm from any window or air vent;
- (e) no more than 900mm from the point connected to the 240V AC voltage;
- (f) no more than 600mm from the sides of other devices.

Make sure that when the battery is installed in any corridor, lobby or any similar place leading to an emergency exit, there is an adequate distance of at least 1 meter from the safety exit.

#### Residential barrier

In order to prevent a fire from spreading in the space where the energy storage system is installed, install a non-combustible barrier on the side of the wall or structural surface with its other side installed with the energy storage system. If the installation surface is not made of a non-combustible material, a non-combustible barrier can be installed between the energy storage system and the wall or structural surface.

If the energy storage system is installed on a wall or at a distance of 300mm from the wall that isolates the energy storage system from a residential space, the distance from other structures or objects must be increased. Be sure to keep the following distances:

- (i) at least 600mm between both sides of the battery;
- (ii) at least 50mm above the battery;
- (iii) the interval between multiple units installed should be at least 600mm.

If the distance between the energy storage system and the ceiling or any object above it is less than 50mm, the ceiling or structural surface above must be made of non-combustible materials and its radius should be within 600mm.

The distance between the highest point of the installed energy storage system and the ground or platform should not exceed 2.2 meters.

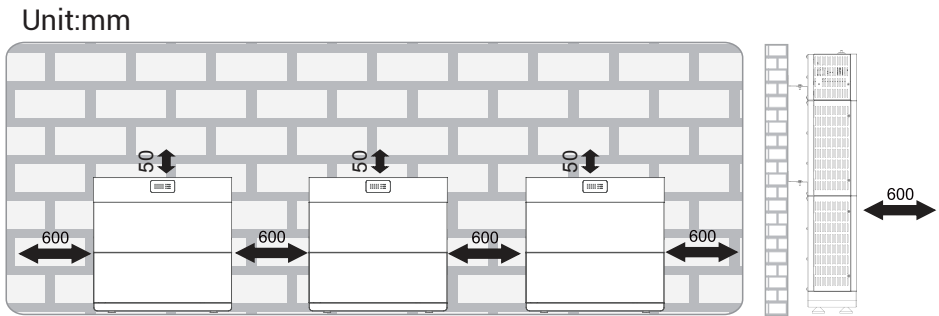

*Installation distances from adjacent objects*

Position	Min size
Left	600mm
Right	600mm
Top	50mm
Front	600mm

## 2.2 Installation

### System Appearance

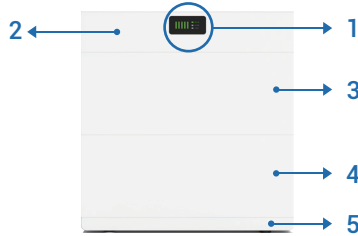



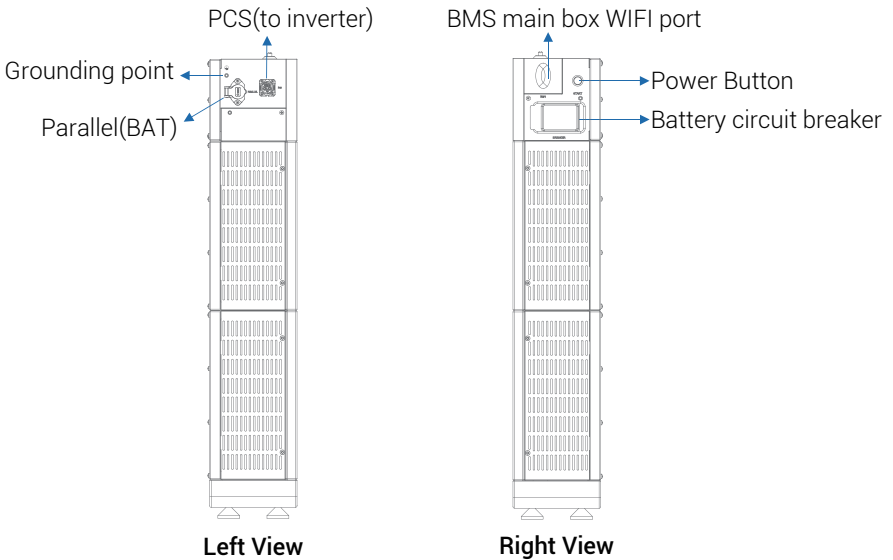







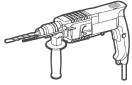

HEC2-BHP series	
1	LED Display Screen
2	BMS main box
3	Battery pack
4	Battery pack
5	Base

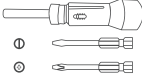
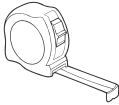

*HEC2-BHP series user interface*



## Required for installation

Installation tools			
 impact drill( $\Phi$ 10mm drill)	 Torque socket wrench	 marker pen	 Vacuum cleaner
 torque wrench	 Torque screwdriver	 Steel tape	 Level ruler
 Electric batch (with M6 socket)	 Multimeter	 Hammer	
Personal Protective Equipment			
 safety gloves	 safety goggles	 dust mask	 Safety shoes

## Required for installation

The battery pack height must comply with local regulations. If the positioning plate conflicts with the regulations, the regulations must be met first.

**Step 1:** Determine the position of the base: mainly determine the height from the ground and the distance from the wall; The distance from the wall is 65mm, and keep horizontal;

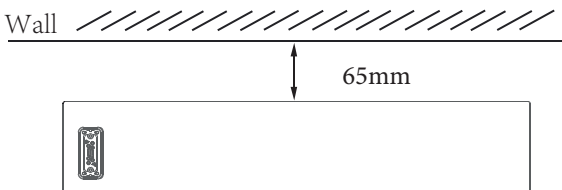

**Step 2:** Use four cross recessed pan head screws and a three component M5x14 unit to install the battery pack, and wall battery mounts. As shown in the following figure.

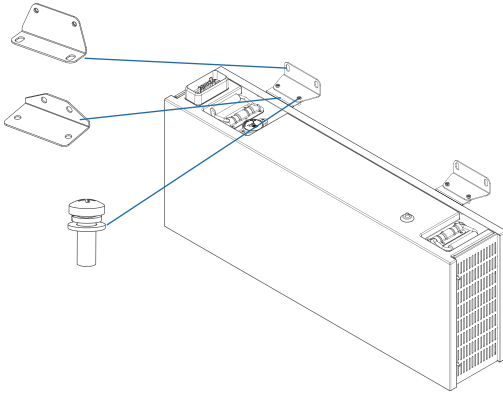

**Step 3:** Stack the installed batteries on top of the already placed base.

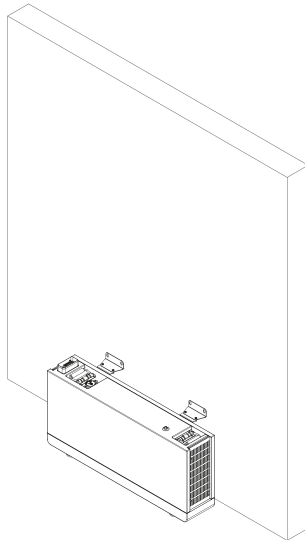

**Step 4:** Use a marker to draw dots at the red intersection in the following image. After drawing the dots, remove the wall battery pendant and use a drill bit to drill holes.

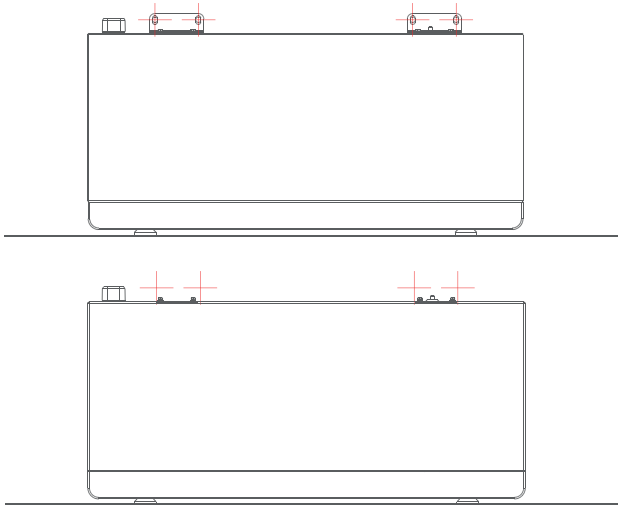

**Step 5:** Install expansion bolts in the drilled holes. Use the expansion bolt with its own M8 nut to fix the wall battery pendant with the expansion bolt. Afterwards, use four cross recessed pan head screws with M5x14 to fix the wall battery mount and pack mount.

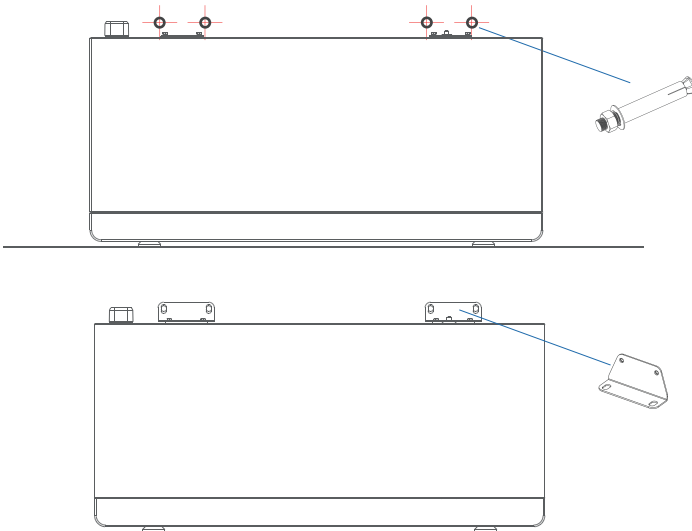

**Step 6:** Repeat steps 2 to 5 to install the other battery modules required. Please align the lower battery with the front of the upper battery during installation.

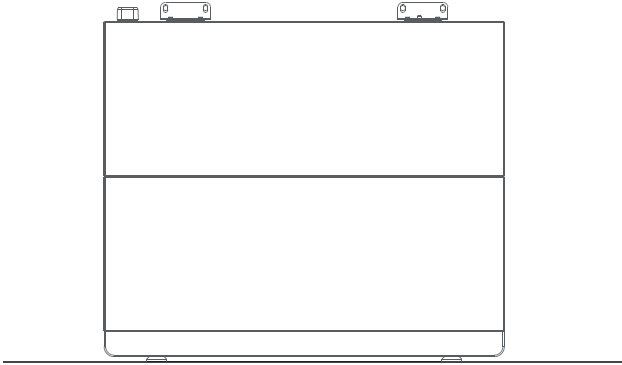

**Step 7:** After installing the battery module, place the high-voltage box on top of the battery box. Please align the high-voltage box with the front of the lower battery during installation.

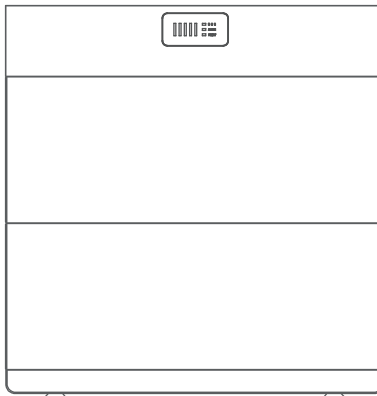

### 2.3 Communication connection

The communication between the BMS and the inverter is RS485 and CAN. The communication between pack and pack is Daisy chain. The communication between the BMS main box and the parallel BMS main box is CAN.

BMS main box WIFI port can be used for BMS monitoring separately and BMS communication also communicated to inverter using PCS-BAT connector.

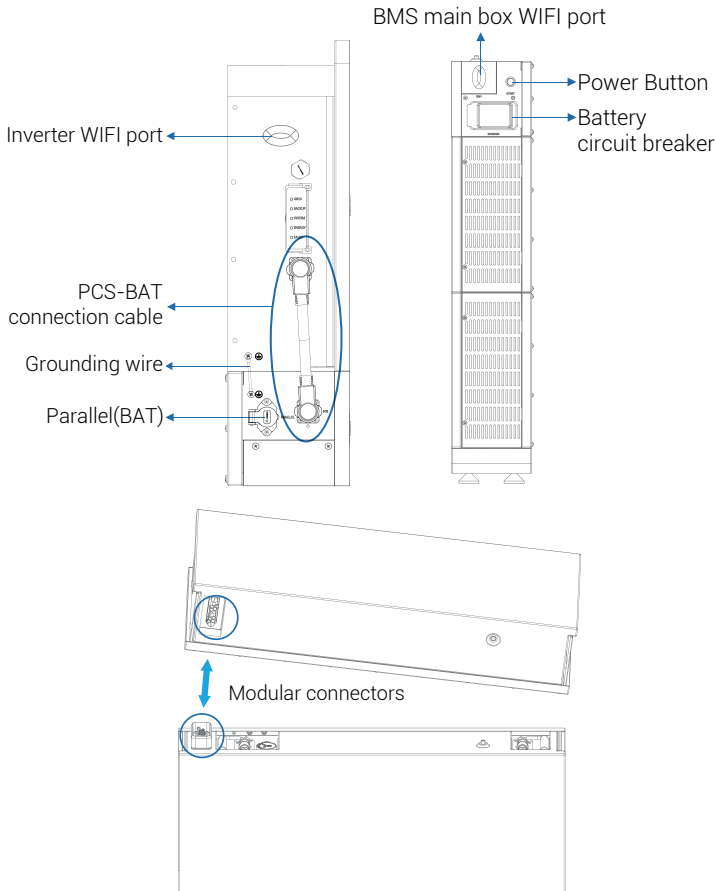

**Precaution:**

Remote monitoring of battery system is available as part of inverter energy system monitoring app. The monitoring data of the battery is communicated by using PCS port (using PCS-BAT cable) to the inverter.

## 2.4 Cable connection

The HEC2-BHP system (without inverter) is cableless installation design which includes pre-installed internal connections. The modular stack installation directly plug-in and completes the series connection between battery modules. The connection between The HEC2-BHP system (from BMS main box) and the inverter requires a cable connection using PCS-BAT connector which includes power connection, communication and grounding. Also, there's a separate grounding connection between BMS main box and inverter.

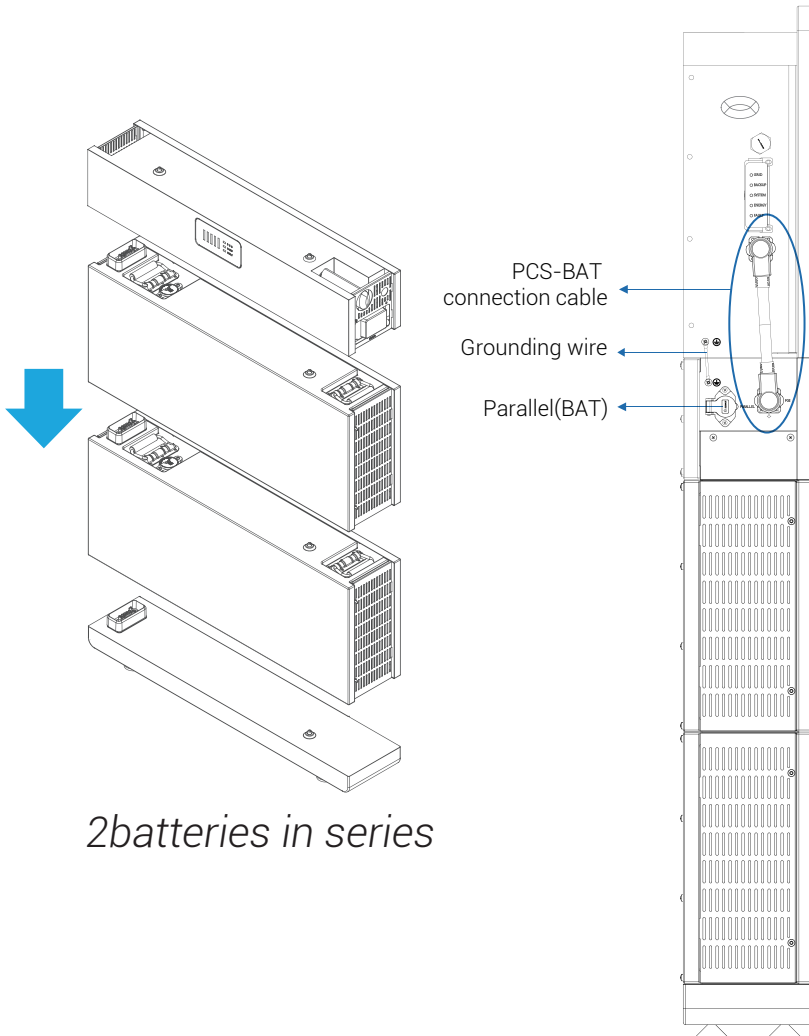

1.If you want to install the HEC2-BHP200r2-A ,HEC2-BHP300r2, HEC2-BHP400r2 series battery packs, you need to connect cable to the parallel ports of the two BMS main boxes.

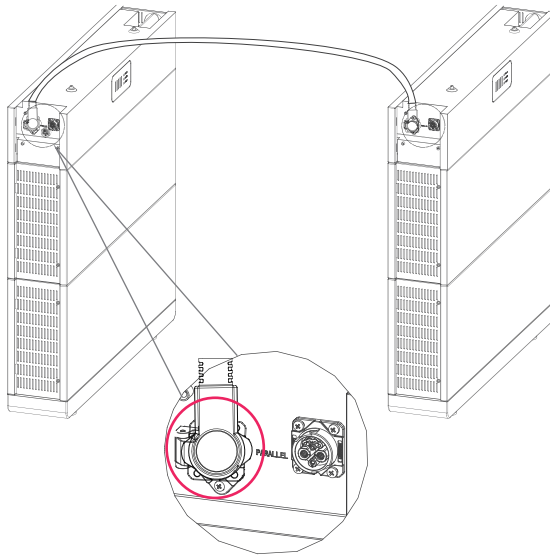

*Two sets in paralleling*

Precaution:

- 1 The product has a ground wire fixed at the grounding point of the BMS control box to connect to the inverter grounding point.
- 2 The PACK and PCS connection cable should not exceed three meters.
- 3 The grid port using the external wiring completes the grounding of the entire system
- 4 The battery shall used with hybrid inverter of HEC2-S3.8/5/6Hr2 series and HEC2-T8/10/12/15Hr2.series And HEC2-BHP50r2 can only be used with HEC2-S3.8/5/6Hr2 series.

### 3. System operation

#### 3.1 Start

Open the battery circuit breaker cover and switch on the BMS main box switch.

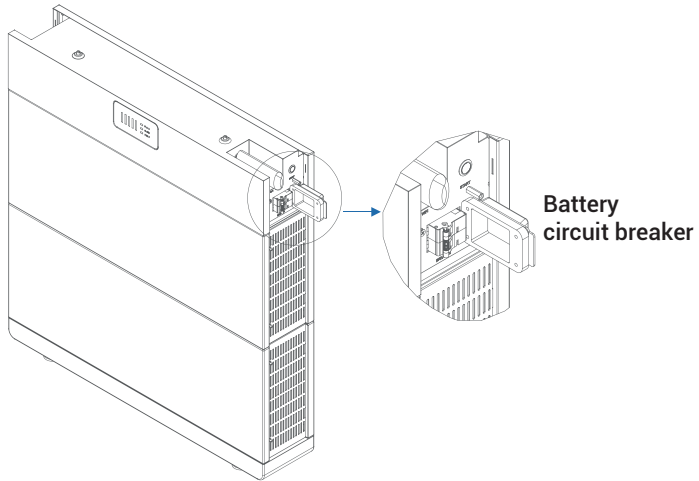

Precaution:

When using battery PACKs in parallel, if the indicator light of one of the BMS main box does not work, please check whether or not the cable of this battery is connected properly.

#### 3.2 Turn off

1. Open the battery switch cover and switch off the BMS main box switch.

Precaution:

Please make sure that the battery is not being charged or discharged before performing a shutdown.

#### 3.3 Emergency procedure

##### Emergency response plan

1. Check the control power supply, if it is normal, check the power supply again to find out the cause.



2. Please record every detail related to the fault for analysis and troubleshooting. Do not perform any operation on the equipment while it is malfunctioning. Please contact HICONICS service support as soon as possible.
3. Since the battery contains a small amount of oxygen, and all batteries have explosion-proof valves, there is almost no chance of explosion.
4. When the battery indicator is lit red to indicate a fault, check the fault type through the communication protocol and contact our aftersales personnel for consultation.

## Hazards

If the battery PACK leaks the electrolyte, avoid contact with the leaking liquid or gas. If you come into contact with the leaking matter, take the following measures immediately:

Inhalation: Leave the contaminated area and seek medical attention.

Eye contact: Rinse eyes with tap water for 5 minutes and then seek medical attention.

Skin contact: Wash the affected area thoroughly with soap and water and seek medical attention.

Eating by mistake: Seek medical attention if vomiting occurs

## Fire

If a fire occurs at the battery PACK installation location, please perform the following operations:

### Fire extinguishing media

No respirator is required for normal operations. Burning batteries cannot be extinguished with ordinary fire extinguishers but special fire extinguishers, such as Novec1230, FM-200 or dioxin fire extinguishers. When not caused by a battery, a fire can be extinguished with ordinary ABC fire extinguishers.

### Fire protection instructions

1. If a fire occurs while the battery is charged, disconnect the battery PACK and cut off the circuit breaker of the charging power supply under safe conditions.

2. If the battery PACK has not caught fire, please put out the fire before the battery PACK catches fire.
3. If the battery PACK catches fire, do not try to extinguish the fire but evacuate people immediately.

---

**Precaution:****Warning!**

When the temperature of the battery exceeds 150°C, it may explode. The burning battery PACK will leak toxic gases, do not approach it.

---

**Effective ways to deal with accidents**

Batteries in dry environments: Place the damaged battery in an isolated place and notify the local fire department or service engineer. Batteries in humid environments: If any part of the battery or inverter or any wiring part is submerged, do not touch any of them. Do not use again the damped or submerged battery, please contact the maintenance engineer in time.

## 4. Battery status description

### 4.1 Panel description



Table1 LED function display

State	Discription	RUN	ALM	FAU	Battery SOC indicator					Discription	
		●	●	●	●	●	●	●	●		
System power off	Power off	off	off	off	off	off	off	off	off	off	off
System standby	Normal	Blinking1	off	off	Based on real SOC power indication					Standby mode	
	Warning	Blinking1	Blinking2	off						Battery pack low voltage/low SOC/low temperature	
	Fault	Blinking1	off	Blinking3						Communication/equipment damage	
Charging mode	Normal	On	off	off	Based on real SOC power indication						
	Warning	On	Blinking2	off	All the LED blinking 2					When the battery fully charged, all the SOC LED blinking 2;When overcharge warning, Alarm LED blinking 2.	
	Overcharge protection	On	off	off	On	On	On	On	On	After activating the overcharge protection for a period of time, if there is no charging current input,then it transitions to standby mode.	
	Over current protection	Off	Blinking1	Blinking1	Off Off Off Off Off					Stop charging	
	Voltage difference protection	Off	Blinking1	Blinking1						If the voltage difference of the battery cell exceeds the allowable value,start the protection and stop charging	
	Communication fault	Off	Blinking1	Blinking3						BMS internal and PCS communication failure, start protection, stop charging	
Temperature fault	Off	Blinking2	Blinking2	If the NTC temperature difference/rise exceeds the allowable value, start protection and stop charging							
	Normal	On	Off	Off	Based on real SOC power indication					Discharging normally	

Discharging mode	Low SOC warning	On	Blinking2	Off	Blinking 2	Off	Off	Off	Off	If the battery level is lower than the set SOC value, an alarm will be triggered, and the minimum battery level LED will flash to stop discharging
	Over current protection	Off	Blinking1	Blinking1						Stop discharging
	Voltage difference protection	Off	Blinking1	Blinking2						If the voltage difference of the battery cell exceeds the allowable value, start the protection and stop discharging
	Communication fault	Off	Blinking1	Blinking3	Off	Off	Off	Off	Off	BMS internal and PCS communication failure, start protection, stop discharging
	Temperature fault	Off	Blinking2	Blinking2						If the NTC temperature difference/rise exceeds the allowable value, start protection and stop discharging
Fault	Equipment fault	Off	Off	On	Off	Off	Off	Off	Off	Stop charging and discharging

Table 2 Instructions for the Operation of the Power LED

State	Charge mode					Discharge mode					
	L1	L2	L3	L4	L5	L1	L2	L3	L4	L5	
SOC LED lights	●	●	●	●	●	●	●	●	●	●	
SOC	0~20%	Blinking2		Off	Off	Off	Blinking2	On	On	On	
	20%~40%	One by one light up		Off	Off	Off	On	Blinking2	Off	Off	
	40%~60%	One by one light up			Off	Off	On	On	Blinking2	Off	
	60%~80%	One by one light up				Off	On	On	On	Blinking2	
	80%~100%	One by one light up					On	On	On	On	Blinking2
	Over charge protection	On	On	On	On	On	On	On	On	On	On
Battery running indicator light	Normal ●					Blinking (Blinking2)					

Table 3 Explanation of LED working indicator flashing

Type	On	Off
Blinking1	0.25s	3s
Blinking2	0.5s	2s
Blinking3	0.75s	1s

**Note:**

1. The LED indicator alarm can be enabled or disabled through the host and is enabled by default as a factory setting.
2. Further ESD monitoring is achieved via inverter monitoring.

## 5. Battery storage and recharging

### 5.1 Battery storage requirements

Storage environment requirements:

–Store batteries in a dry and well-ventilated place at room temperature or lower.

While batteries can be used safely between -20 and 55 °C (-4 to 131 °F), it is strongly suggested to avoid storing them at a temperature that is close to the upper or lower range.

- Storing batteries in a refrigerator may create internal condensation when the battery is brought to room temperature, and they may become dangerous when operated.
- It is best to have a reserved area ONLY for lithium-ion battery storage. It has to be a cool and dry place, away from heat sources.
- The area should be maintained free from any materials which can catch fire such as wood tables, carpet, or gasoline containers. The ideal surface for storing lithium-ion batteries is concrete, metal, or ceramic or any non-flammable material.
- Batteries can be stored in a metal cabinet such as a chemical-storage cabinet, make sure that batteries are not touching each other.
- It is recommended to have in place a fire detector in the storage area.
- Never leave batteries unattended where they can be damaged by someone.

- Have a class ABC or CO2 fire extinguisher nearby the storage area.
- Make sure the working surface is made of a material that is not conductive and non-combustible. If you are working on a conductive material cover the surface with an insulating material.
- The area should be clear of any flammable or combustible materials such as wood tables, carpet and gasoline or other solvent.
- Keep the area free from any sharp objects that may puncture the insulating
- Keep the area free from any sharp objects that may puncture the insulating

## 5.2 Storage expiration

In principle, it is not recommended to store the battery for a long time. Be sure to use it in time. The stored batteries should be disposed according to the following requirements.

### Stored lithium battery recharging interval

Required Storage Temperature	Recharge Interval
0°C ~ +45°C	6 months

- 1 If a battery is deformed, broken or leaking, discard it immediately regardless of its storage time.
- 2 The allowable maximum stored battery recharging period is 3 years and the allowable maximum stored battery recharging times is 3. For example, if recharging is performed once every 6 months, the allowable maximum recharging times is 3 times; if the allowable maximum stored battery recharging period or times is exceeded, it is recommended to discard the battery.
- 3 A lithium battery will have its capacity decreasing after being stored for a long time, and typically will have its capacity irreversibly decreasing by 3%–10% after being stored at the recommended storage temperature for 12 months. If the customer conducts the discharge test and acceptance according to the specification, there is a risk that the battery with a capacity less than 100% after being stored will fail the test.

### 5.3 Inspection before battery recharging

Before recharging a battery, check its appearance: Deformation/Shell. damage/Leakage

### 5.4 Recharge Operation Steps

NOTICE: It is not recommended for users to charge the battery packs by themselves. It is recommended to contact professional after-sales staff for operation.

**Step 1:** Connect power cables to the battery charger correctly. The power cables must be compatible with the product interface, which should include Battery positive and negative power wires and RS485 communication wires. Users can use host software by RS485 communication to monitor the status of battery packs in real-time.

**Step 2:** Turn on the BMS main box DC breaker to ON. Check the LED on the BMS main box is on.

**Step 3:** Turn on the battery charger.

**Step 4:** Set charging parameter on the battery charger.

Case #1, Two battery PACKs are charged. Set the charge limited voltage 205 V;

Set the charge limited current 25A;

Case #2, Six battery PACKs are charged. Set the charge limited voltage 307.2V;

Set the charge limited current 50A;

**Step 5:** After the battery is charged, switch off the battery charger and the battery DC breaker. Disconnect the power cables.

## 6. Battery port definition and parameters

### 6.1 Port definition

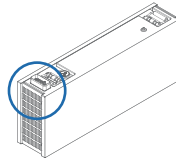
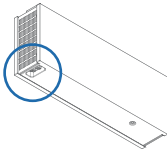

1	2	3	4	5	6	7	8
BP+	B-	PE	NA	NA	NA	M-TP	M-TN
9	10	11	12	13	14	15	
M-LP	M-LN	NA	NA	BJ+	JR-	NA	

1	2	3	4	5	6	7	8
BP-	B-	PE	NA	NA	NA	M-TP	M-TN
9	10	11	12	13	14	15	
M-LP	M-LN	NA	NA	BJ-	JR-	NA	

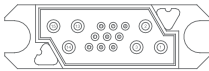

Modular connector plug pin definition

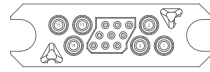

Modular connector socket pin definition

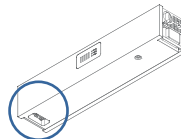
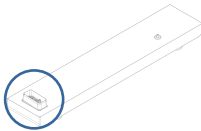

1	2	3	4	5	6	7	8
BP-	B-	PE	NA	NA	NA	M-IP2	M-IM2
9	10	11	12	13	14	15	
C-IP2	C-IM2	NA	NA	BJ+	JR-	NA	

1	2	3	4	5	6	7	8
B+	B-	PE	NA	NA	NA	TPL-P	TPL-N
9	10	11	12	13	14	15	
LP_P	LP_N	NA	NA	JR-	JR-	NA	

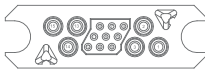

Modular connector socket pin definition (BAT-BASE)

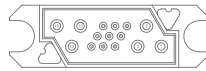

Modular connector plug pin definition(BMS-PACK)

#### Description:

'BP+' and 'BP-' are positive and negative pole output lines of the battery pack.

'B-' is Negative electrode input line of BMS main box.

'PE' is ground line.

'M-TP/TN' is daisy chain connection interface

'BJ+', 'BJ-' are heating film input and output line of battery pack.



'JR-' is negative electrode output of BMS main box heating film.

'NA' indicates that this interface is undefined.

The thick red connecting lines represent the corresponding pin short circuiting.

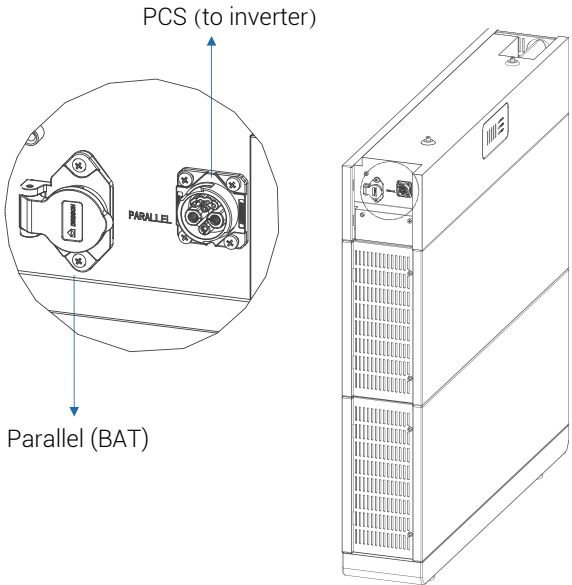

### PARALLEL(BAT) interface

The communication between parallel battery packs is CAN.

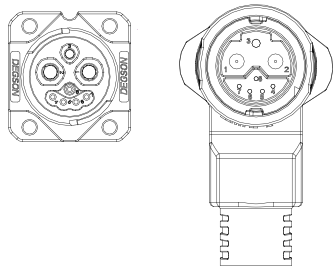

*PARALLEL(BAT) interface pin description*

1	2	3	4	5	6	7	8
P'+	P'-	GND	CAN1H	CAN1L	CAN2H	CAN2L	GND

**PCS (to inverter) Interface**

The communication between PCS and BAT is RS485 and CAN.

*PCS-BAT interface pin description*

1	2	3	4	5	6	7	8
P+	P-	GND	485A	485B	CANH	CANL	GND

## 6.2 Battery parameters

Model	HEC2-BHP50r2	HEC2-BHP100r2	HEC2-BHP150r2	HEC2-BHP200r2	HEC2-BHP200r2-A	HEC2-BHP300r2	HEC2-BHP400r2
Component	Base+BMS +1*PACK	Base+BMS +2*PACK	Base+BMS +3*PACK	Base+BMS +4*PACK	2*(Base+BMS +2*PACK)	2*(Base+BMS +3*PACK)	2*(Base+BMS +4*PACK)
Voltage	102.4V	204.8V	307.2V	409.6V	204.8V	307.2V	409.6V
Recommend operating voltage range (@90%DOD)	92.8V-112V	185.6V-224V	278.4V-336V	371.2V-448V	185.6V-224V	278.4V-336V	371.2V-448V
Battery pack	PACK*1	PACK*2	PACK*3	PACK*4	PACK*4	PACK*6	PACK*8
Nominal capacity	50Ah	50Ah	50Ah	50Ah	100Ah	100Ah	100Ah
Total energy	5.1kWh	10.2kWh	15.3kWh	20.4kWh	20.4kWh	30.6kWh	40.8kWh
Usable energy (@90%DOD)	4.59kWh	9.18kWh	13.77kWh	18.36kWh	18.36kWh	27.54kWh	36.72kWh
Battery roundtrip efficiency	94%	94%	94%	94%	94%	94%	94%
Nominal power	2.56kW	5.12kW	7.68kW	10.24kW	10.24kW	15.36kW	20.48kW
Nominal charge/ discharge current	25A	25A	25A	25A	50A	50A	50A
Cycle life	6000 Cycles (60%)						
Expected life time	10 Years (60%)						
Available discharge/ charge temperature range	-20°C to 55°C (derating at 45°C) / 0°C to 55°C(derating at 45°C) -20 °Cto 55°C (derating at 45) / -20 °Cto 55°C(derating at 45, build-in heating function Optional)						
Storage temperature	0°C to 40°C (6 months)						
Humidity	15~95%						
Altitude	Below 2000m						
Protection	IP65						
System to Inverter	RS485/CAN2.0						
Battery to battery / BMS	Daisy chain						
Display Interface	LED						
Switch on/off	Button*1+Breaker*1						
Certificate	CE,IEC62619,IEC62040,IEC60529,IEC61000,UN38.3,UL1973						
Hazardous materials classification	Class 9						
Weight	75±3kg	130±5kg	185±7kg	240±9kg	260±10kg	370±14kg	480±18kg
External dimensions: (W*H*D) (mm)	800±20*610 ±30*160±20	800±20*920 ±30*160±20	800±20*1230 ±30*160±20	800±20*1540 ±30*160±20	1600±20*920 ±30*160±20	1600±20*1230 ±30*160±20	1600±20*1540 ±30*160±20
<b>Remark</b>	1 Series	1 Series	1 Series	1 Series	2 Series Parallel	2 Series Parallel	2 Series Parallel

## 7. Routine maintenance

Note that the maintenance should be conducted by certified electricians.

### 7.1 Maintenance plan

1. Check whether or not any wire connection is loose.
2. Check whether or not any cable is aging/broken.
3. Check whether or not any cable insulation peels off.
4. Check whether or not any cable terminal screw is loose and whether or not there is any sign of overheating.
5. Check whether or not the grounding connection is proper.

### Operating environment

(Every six months) carefully observe whether or not the battery system equipment malfunctions or is broken; listen for abnormal noises in various parts of the inverter when the inverter is running.

While the inverter is running, check whether or not the parameters such as the voltage, temperature, etc. of the battery and other equipment parameters are normal.

### Equipment cleaning

(Once every six months to a year, depending on the site environment and dust content, etc.) make sure that the ground is clean, the maintenance channel is unobstructed and that the warning and guidance signs are clear and intact. Monitor the temperature of the battery module and clean the battery module if necessary.

### Equipment inspection

Once every six months to one year

1. Check whether or not any cable connection is loose.
2. Check whether or not any cable is aging/broken.
3. Check whether or not any cable tie falls off.
4. Check whether or not any cable terminal screw is loose and whether or not there is any sign of overheating in the terminal position.
5. Check whether or not any management system of the inverter and battery equipment, monitoring system or other related equipment malfunctions or is broken.

6. Check whether or not the equipment is well grounded and the grounding resistance is less than 10 ohms.

## 7.2 Cautions

After the equipment stops running, please pay attention to the following matters during maintenance:

1. Operations and maintenance shall comply with the relevant safety standards and regulations.
2. Disconnect all electrical connections to prevent the equipment from being energized.
3. Appropriate protective measures should be taken during maintenance, such as insulating gloves, shoes, noise-proof earplugs, etc.
4. Life is priceless. Make sure that no one will get hurt first.
5. In the case of deep discharge, if the whole inverter is in a static state (i.e., the battery has not been charged for two weeks or more), the battery must be charged to an SOC of 30% to 50%.
6. Equipment maintenance can only be carried out by professionals. Maintenance personnel are forbidden from opening any equipment module by themselves.

This manual is only used as a guide and reference for installation and operations. If there is any matter not specified in this manual, please contact us in time.

## 8. Fault codes and solutions

When you encounter any of the following problems, please refer to the following solutions. If the problem is still not resolved, please contact your local distributor. The following table lists some basic problems that may occur during actual operations and corresponding basic solutions to the problems.

## Error codes and troubleshooting

Fault code	Fault name	Solution
1	BMS communication failure	Disconnect the AC output switch, DC input switch and Battery switch, then connect them 5 minutes later. Contact the dealer or the after-sales service if the problem persists.
2	Battery overvoltage alarm	Disconnect the AC output switch, DC input switch and Battery switch, then connect them 5 minutes later. Contact the dealer or the after-sales service if the problem persists.
3	Battery undervoltage alarm	Disconnect the AC output switch, DC input switch and Battery switch, then connect them 5 minutes later. Contact the dealer or the after-sales service if the problem persists.
4	Battery over temperature alarm	Disconnect the AC output switch, DC input switch and Battery switch, then connect them 5 minutes later. Contact the dealer or the after-sales service if the problem persists.
5	Battery under temperature alarm	Disconnect the AC output switch, DC input switch and Battery switch, then connect them 5 minutes later. Contact the dealer or the after-sales service if the problem persists.
6	Battery overcurrent alarm	Disconnect the AC output switch, DC input switch and Battery switch, then connect them 5 minutes later. Contact the dealer or the after-sales service if the problem persists.
7	Battery voltage difference too large	Disconnect the AC output switch, DC input switch and Battery switch, then connect them 5 minutes later. Contact the dealer or the after-sales service if the problem persists.
8	Temperature difference too large	Disconnect the AC output switch, DC input switch and Battery switch, then connect them 5 minutes later. Contact the dealer or the after-sales service if the problem persists.
9	Battery SOC too high	Disconnect the AC output switch, DC input switch and Battery switch, then connect them 5 minutes later. Contact the dealer or the after-sales service if the problem persists.
10	Battery SOC too low	Disconnect the AC output switch, DC input switch and Battery switch, then connect them 5 minutes later. Contact the dealer or the after-sales service if the problem persists.
11	Other battery alarms	Disconnect the AC output switch, DC input switch and Battery switch, then connect them 5 minutes later. Contact the dealer or the after-sales service if the problem persists.

12	DC bus over voltage	Disconnect the AC output switch, DC input switch and Battery switch, then connect them 5 minutes later. Contact the dealer or the after-sales service if the problem persists.
13	DC bus under voltage	Disconnect the AC output switch, DC input switch and Battery switch, then connect them 5 minutes later. Contact the dealer or the after-sales service if the problem persists.
14	PCS over temperature	<ol style="list-style-type: none"> <li>1. Check the ventilation and the ambient temperature at the installation point.</li> <li>2. If the ventilation is poor or the ambient temperature is too high, improve the ventilation and heat dissipation.</li> <li>3. Contact the dealer or after-sales service if both the ventilation and the ambient temperature are normal.</li> </ol>
15	Battery side DC over voltage	<ol style="list-style-type: none"> <li>1. If the problem occurs occasionally, check battery input voltage, if it's within normal range, The inverter will recover automatically.</li> <li>2. Contact the dealer or the after-sales service if the problem occurs frequently.</li> </ol>
16	Battery side DC under voltage	<ol style="list-style-type: none"> <li>1. If the problem occurs occasionally, check battery input voltage, if it's within normal range, The inverter will recover automatically.</li> <li>2. Contact the dealer or the after-sales service if the problem occurs frequently.</li> </ol>
17	Recharge abnormal	Disconnect the AC output switch, DC input switch and Battery switch, then connect them 5 minutes later. Contact the dealer or the after-sales service if the problem persists.
18	Hardware Battery Over Voltage	Disconnect the AC output switch, DC input switch and Battery switch, then connect them 5 minutes later. Contact the dealer or the after-sales service if the problem persists.

## Protection codes and description

0x340 DATE4,5	Protecting Flag	Troubleshooting
BIT2	BMS communication failure	Turn off the high-voltage box switch in the version and start it after 10 seconds. If there is still a problem, contact the maintenance personnel
BIT3	Battery overvoltage alarm	Please connect PCS discharge
BIT4	Battery undervoltage alarm	Please connect PCS for charging
BIT5	Battery overtemperature alarm	Please shut down the machine and wait for recovery. It cannot be restored within 2 hours. Contact the maintenance personnel
BIT6	Battery undertemperature alarm	Please connect the PCS, the system will automatically heat the battery, and it cannot be restored within 2 hours. Contact the maintenance personnel
BIT7	Battery overcurrent alarm	It will automatically recover. If it persists for a long time, please shut down the machine and contact the maintenance personnel
BIT8	Battery voltage difference too large	Unable to resume contact with maintenance personnel after 2 hours of shutdown
BIT9	Temperature difference too large	Unable to resume contact with maintenance personnel after 2 hours of shutdown
BIT10	Battery SOC too high	Please connect PCS discharge
BIT11	Battery SOC too low	Please connect PCS for charging
BIT12	Other battery alarms	Turn off the high-voltage box switch and start the machine 10 seconds later. If there is still a problem, contact the maintenance personnel



## 9. Quality commitments

If the product malfunctions during the warranty period, HICONICS or its distributors will provide free service or replace it with a new product.

### Documents

During the warranty period, the customer shall provide the product purchase invoice and date. In addition, the trademark on the product shall be intact and clear. Otherwise HICONICS has the right to refuse to fulfil the warranty.

### Criteria

- The unacceptable product replaced will be disposed by HICONICS.
- The customer should allow HICONICS or its distributors to take reasonable time to repair the malfunctioning equipment.

### Exemption from liabilities

In any of the following cases, HICONICS has the right to refuse to fulfil the warranty:

- The warranty period of the whole device/parts has expired;
- The equipment is broken during transportation;
- The equipment is installed, reinstalled or used improperly;
- The equipment is used in any of the harsh environments described in this manual;
- The malfunction or breakage is caused by installation, repair, modification or disassembly performed by the service provider or the personnel other than HICONICS's or its authorized partners' personnel;
- The malfunction or damage is caused by abnormal use or use non-compliant with HICONICS's standards.

### Components or software

- The scope of installation and use does not comply with relevant international standards.
- Any damage caused by accidental natural factors.

For the product that malfunctions in any of the above cases, if the customer requires maintenance, we can provide paid maintenance services based on HICONICS's judgment.



**HICONICS ECO-ENERGY DRIVE TECHNOLOGY CO., LTD.**

No.3 Boxing 2nd Road, Economic and Technological Development Zone,  
Daxing District, 100176, Beijing, China  
Tel: +86 10 5918 0033 Email: huchu@midea.com