



X1-SMART G2

5 kW / 6 kW / 7 kW
8 kW / 9 kW / 10 kW

User Manual

Version 0.0

www.solaxpower.com



eManual in the QR code or at
<http://kb.solaxpower.com/>

STATEMENT

Copyright

Copyright © SolaX Power Technology (Zhejiang) Co., Ltd. All rights reserved.

No part of this manual may be reproduced, transmitted, transcribed, stored in a retrieval system, or translated into any language or computer language, in any form or by any means without the prior written permission of SolaX Power Technology (Zhejiang) Co., Ltd.

Trademarks



SOLA X and other symbol or design (brand name, logo) that distinguishes the products or services offered by SolaX has been trademark protected. Any unauthorized use of above stated trademark may infringe the trademark right.

Notice

Please note that certain products, features, and services mentioned in this document may not be within the scope of your purchase or usage. Unless otherwise specified in the contract, the contents, information, and recommendations presented in this document are provided "as is" by SolaX. We do not provide any warranties, guarantees, or representations, whether express or implied.

Note that the content of the documents is reviewed and updated as needed. However, occasional discrepancies may occur. SolaX retains the right to enhance or modify the product(s) and program(s) described in this manual without prior notice.

The images included in this document are solely for illustrative purposes and may differ based on the specific product models.

For more detailed information, kindly visit the website of SolaX Power Technology (Zhejiang) Co., Ltd. at www.solaxpower.com.

SolaX retains all rights for the final explanation.

About This Manual

Scope of Validity

This manual is an integral part of X1-SMART G2 Series inverter. It describes the installation, electrical connection, commissioning, maintenance and troubleshooting of the product. Please read it carefully before operating.

| | |
|--------------|---------------|
| X1-SMT-5K-G2 | X1-SMT-6K-G2 |
| X1-SMT-7K-G2 | X1-SMT-8K-G2 |
| X1-SMT-9K-G2 | X1-SMT-10K-G2 |

Note:

"X1-SMART G2" Series refers to the grid-connected photovoltaic inverter that supports grid connection of photovoltaic system.

"X1" means single-phase. "SMT" is the abbreviation of the series name.

"10K" means the rated output power is 10 kW.

"G2" means second generation.





Target Group

The installation, maintenance and grid-related setting can only be performed by qualified personnel who

- Are licensed and/or satisfy state and local jurisdiction regulations.
- Have good knowledge of this manual and other related documents.

Conventions

The symbols that may be found in this manual are defined as follows.

| Symbol | Description |
|---|--|
|  DANGER | Indicates a hazardous situation which, if not avoided, will result in death or serious injury. |
|  WARNING | Indicates a hazardous situation which, if not avoided, could result in death or serious injury. |
|  CAUTION! | Indicates a hazardous situation which, if not avoided, could result in minor or moderate injury. |
|  NOTICE! | Provides tips for the optimal operation of the product. |

Change History

Version 00 (2023-11-24)

Initial release

Table of Contents

- 1 Safety 1
 - 1.1 General Safety 1
 - 1.2 Safety Instructions of PV, Inverter and Grid 1
 - 1.2.1 Safety Instructions of PV 2
 - 1.2.2 Safety Instructions of Inverter 2
 - 1.2.3 Safety Instructions of Utility Grid 3
 - 1.3 Additional Safety Instructions 4
- 2 Product Overview 6
 - 2.1 System Description 6
 - 2.2 Supported Power Grid 8
 - 2.3 Appearance 9
 - 2.3.1 Dimensions 10
 - 2.3.2 Control Panel 11
 - 2.3.3 Terminals of Inverter 12
 - 2.3.4 Symbols on the Label and Inverter 13
 - 2.4 Circuit Principle Diagram 14
- 3 Transportation and Storage 15
- 4 Preparation before Installation 16
 - 4.1 Selection of Installation Location 16
 - 4.1.1 Environment Requirement 16
 - 4.1.2 Installation Carrier Requirement 17
 - 4.1.3 Clearance Requirement 18
 - 4.2 Tools Requirement 19
 - 4.3 Additionally Required Materials 20
- 5 Unpacking and Inspection 21
 - 5.1 Unpacking 21
 - 5.2 Scope of Delivery 22
- 6 Mechanical Installation 23
- 7 Electrical Connection 28
 - 7.1 PE Connection 28
 - 7.2 AC Connection 32
 - 7.3 PV Connection 37
 - 7.4 Communication Connection 42

| | | |
|-----------|--|-----------|
| 7.4.1 | Wiring Procedures..... | 42 |
| 7.4.2 | Meter/CT Connection..... | 50 |
| 7.4.3 | DRM Connection (Applicable to AS/NZS 4777.2) | 51 |
| 7.4.4 | Parallel Connection..... | 52 |
| 7.4.5 | External Devices Connection..... | 54 |
| 7.5 | Monitoring Connection | 57 |
| 8 | System Commissioning..... | 59 |
| 8.1 | Checking before Power-on..... | 59 |
| 8.2 | Powering on the System..... | 60 |
| 8.3 | Checking after Power-on..... | 61 |
| 8.4 | Lockable DC switch | 61 |
| 9 | Operation on LCD..... | 66 |
| 9.1 | Introduction of Main Interface..... | 66 |
| 9.2 | Introduction of Menu Interface..... | 66 |
| 9.3 | Detailed Operation of Settings | 71 |
| 9.3.1 | Safety | 71 |
| 9.3.2 | Export Control..... | 73 |
| 9.3.3 | Grid Services..... | 74 |
| 9.3.4 | Grid Protection..... | 79 |
| 9.3.5 | Functional Settings | 80 |
| 9.3.6 | Other Settings | 85 |
| 10 | Operation on SolaX App and Web..... | 87 |
| 10.1 | Introduction of SolaXCloud..... | 87 |
| 10.2 | Operation Guide on SolaXCloud App | 87 |
| 10.2.1 | Downloading and installing App..... | 87 |
| 10.2.2 | Operation on the App..... | 88 |
| 10.3 | Operations on SolaXCloud Webpage..... | 88 |
| 11 | Troubleshooting and Maintenance | 89 |
| 11.1 | Power off..... | 89 |
| 11.2 | Troubleshooting..... | 89 |
| 11.3 | Maintenance..... | 93 |
| 11.3.1 | Maintenance Routines..... | 93 |
| 11.3.2 | Upgrading Firmware..... | 94 |
| 12 | Decommissioning..... | 97 |
| 12.1 | Disassembling the Inverter | 97 |
| 12.2 | Packing the Inverter | 101 |
| 12.3 | Disposing of the Inverter | 101 |

13 Technical Data102

1 Safety

1.1 General Safety

The series inverter is well designed and tested to meet all applicable states and international safety standards. However, like all electrical and electronic equipment, safety precautions must be observed and followed during the installation of the inverter to reduce the risk of personal injury and to ensure a safe installation.

Before installing the device, carefully read, fully understand and strictly follow the detailed instruction of the user manual and other related regulations. And the safety instructions in this document are only supplements to local laws and regulations.

SolaX shall not be liable for any consequences caused by the violation of the storage, transportation, installation, and operation regulations specified in this document, including, but not limited to:

- Inverter damage due to force majeure, such as earthquake, flooding, thunderstorm, lighting, fire hazard, volcanic eruption, etc.
- Inverter damage due to man-made cause
- Inverter used or operated against any items in local policy
- Failure to follow the operation instructions and safety precautions on the product and in this document
- Installation and use under improper environment or electrical condition
- Unauthorized modifications to the product or software
- Inverter damage caused during transportation by the customer
- Storage conditions that do not meet the requirements specified in this document
- Installation and commissioning operated by unauthorized personnel who are not licensed and / or satisfy state and local jurisdiction regulations.

1.2 Safety Instructions of PV, Inverter and Grid

Save these important safety instructions. Failure to do so may result in damage to the inverter and injury or even loss of life.

1.2.1 Safety Instructions of PV



Lethal danger from electrical shock due to the PV

- When exposed to sunlight, high DC voltage will be generated by PV modules. Death or lethal injuries will occur due to electric shock.
- Never touch the positive or negative pole of PV connecting device. Touching both of them at the same time is prohibited as well.
- Do not ground the positive or negative pole of the PV modules.
- Only qualified personnel can perform the wiring of the PV panels.



- Make sure that the input DC voltage \leq Maximum DC input voltage of the inverter. Overvoltage may cause permanent damage to the inverter, which is NOT covered by the warranty.

1.2.2 Safety Instructions of Inverter



Lethal danger from electrical shock due to the inverter

- Only operate the inverter when it is technically faultless. Otherwise, electric shock or fire may occur.
- Do not open the enclosure in any case without authorization from SolaX. Unauthorized opening will void the warranty and cause lethal danger or serious injury due to electric shock.
- Only qualified personnel can perform the installation, wiring, maintenance of the inverter following this document and the related regulations.



- During operation, do not touch any parts other than DC switch and LCD panel of the inverter.
- Never connect or disconnect the AC and DC connectors when the inverter is running.
- Turn off the AC and DC power and disconnect them from the inverter, wait for 5 minutes to fully discharge the voltage before attempting any maintenance, cleaning or working on any circuits connected.



Danger of burn injuries due to hot enclosure parts

- During operation, the enclosure may become hot.

 CAUTION!

- Children should be supervised to ensure that they do not play with the appliance.
- Pay attention to the weight of the inverter. Personal injuries may be caused if not handled properly.
- Use insulated tools when installing the device. Individual protective tools must be worn during installation, electrical connection and maintenance.

NOTICE!

- If an external RCD is required by local regulations, check which type of RCD is required for relevant electric codes. It is recommended to use a Type-A RCD with the value of 300 mA.
- All the product labels and nameplate on the inverter shall be maintained clearly visible.

1.2.3 Safety Instructions of Utility Grid

NOTICE!

- Only with permissions of local utility grid company, the inverter can be connected to the grid.

1.3 Additional Safety Instructions

Surge protection devices (SPDs) for PV installation



- Over-voltage protection with surge arresters should be provided when the PV power system is installed. The grid connected inverter is fitted with SPDs in both PV input side and MAINS side.

Direct or indirect lightning strikes can cause failures. Surge is the main cause of lightning damage to most devices. Surge voltage may occur at photovoltaic input or AC output, especially in remote mountain areas where long distance cable is supplied.

Please consult professionals before installing SPDs.

The external lightning protection device can reduce the influence of direct lightning strike, and the lightning protection device can release surge current to the earth.

If the building installed with external light protection device is far away from the inverter location, in order to protect the inverter from electrical and mechanical damage, the inverter should also install an external lightning protection equipment.

In order to protect DC system, two-stage surge protection equipment is needed between DC cable of inverter and photovoltaic equipment module.

In order to protect the AC system, the level 2 surge protection equipment should be installed at the AC output, located between the inverter and the grid. Installation requirements must comply with IEC61643-21 standard.

All DC cables shall be installed in a distance as short as possible, and the positive and negative cables of the same input need to be bundled together to avoid causing loops in the system. Minimum distance installation and binding requirements also apply to auxiliary grounding and shielding grounding conductors.

Anti-Islanding Effect

The islanding effect means that when the power grid is cut off, the grid-connected power generation system fails to detect the power outage and still supplies power to the power grid. This is very dangerous for the maintenance personnel and the power grid on the transmission line. The inverter's use active frequency offset method to prevent islanding effect.

PE Connection and Leakage Current

All inverter's incorporate a certified internal Residual Current Monitoring (RCM) in order to protect against possible electrocution and fire hazard in case of a malfunction in the PV array, cables or inverter. There are 2 trip thresholds for the RCM as required for certification (IEC 62109-2:2011).

The default value for electrocution protection is 30 mA, and for slow rising current is 300 mA. the house loads. If an external RCD is required by local regulations, it is recommended to choose a Type-A RCD with the rating residual current of 300 mA.



- High leakage current!
- Earth connection essential before connecting supply.

A faulty ground connection can result in equipment failure, personal and death injuries, and electromagnetic interference. Ensure correct according to grounding to IEC62109 and conductor diameter according to STANDARD specification. Do not connect the grounding end of the equipment in series to prevent multi-point grounding. Electrical appliances must be installed in accordance with the wiring rules of each country.

For United Kingdom

The installation that connects the equipment to the supply terminals shall comply with the requirements of BS 7671. Electrical installation of PV system shall comply with requirements of BS 7671 and IEC 60364-7-712. All protective devices cannot be changed.

User shall ensure that equipment is so installed, designed and operated to maintain at all times compliance with the requirements of ESQCR22(1)(a).

2 Product Overview

2.1 System Description

The X1-SMART G2 Series is a transformerless single-phase PV grid-connected inverter which is designed to convert the direct current power generated from the PV modules into grid-compatible AC current and feeds the AC current to the utility grid. The way it works depends on user preferences.

X1-SMART G2 series

The X1-SMART G2 series inverter manages system energy.

PV Array

The PV array works in MPPT mode. For the series inverter, the number of PV string is three.

Meter/CT

Meter/CT is used by the inverter for import / export or consumption readings, and for smart energy management applications, for example self-consumption, zero-export, etc.

Grid

220 V / 230 V / 240 V grid are supported.

SolaX Cloud

SolaX Cloud is an intelligent, multifunctional monitoring platform that can be accessed either remotely or through a hard wired connection. With the SolaX Cloud, the operators and installers can always view key and up to date data.

DRM

DRM is applicable for AS/NZS 4777.2:2020. With the use of an external control box, active or reactive power regulation can be realized in a timely and fast manner, and the inverter can be operated stably during the process of regulation.

Adapter Box

SolaX Adapter Box can be matched with a heat pump (the first generation via dry contact function and the second generation via RS485 function) to realize heat pump integrated photovoltaic inverter energy system management.

Datahub

SolaX DataHub is a device for monitoring platforms of photovoltaic power generation systems, which enables data detection, storage, output control, centralized monitoring, and centralized maintenance of devices such as inverters, electricity meters, and environmental monitoring instruments in photovoltaic power generation systems.

EV Charger

SolaX EV-Charger is used for charging electric vehicle.

Generator

A generator is a device which can be matched with the system to supply energy in places where there are frequent power outages.

System Overview

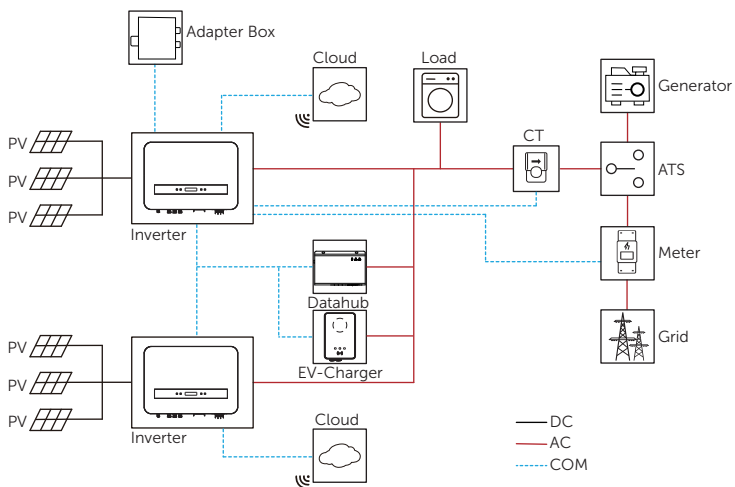

Figure 2-1 System overview diagram

NOTICE!

- The parallel system with Modbus Function, the parallel system with Datahub and the EV-Charger application can not be realised at the same time, choose only one of these applications at a time.

2.2 Supported Power Grid

There are different ways of wiring for different grid systems. Two grid types, TN-S / TN-C-S are shown as below:

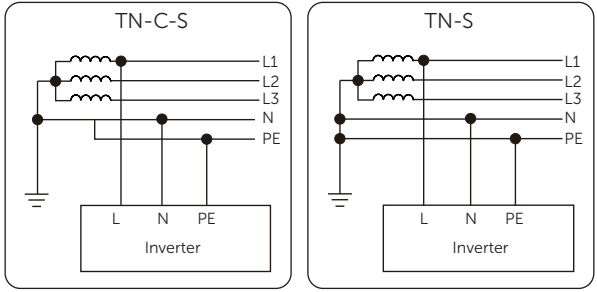

Figure 2-2 Supported power grid

2.3 Appearance

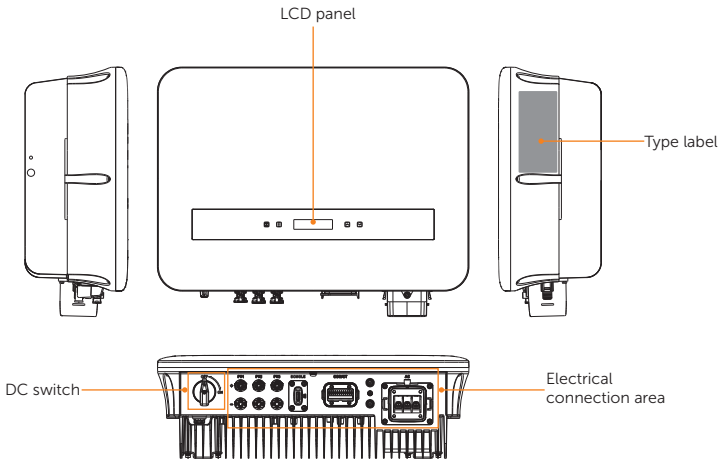

Figure 2-3 Appearance

Table 2-1 Description of appearance

| Item | Description |
|----------------------------|---|
| Type label | Type label clearly identifies the device type, serial number, specific DC / AC parameters, certification, etc. |
| LCD panel | Including screen, indicators and keys. Screen displays the information; indicators indicates the operating status of inverter. Keys is used to perform the parameter setting. |
| DC switch | Disconnect the DC circuit when necessary. |
| Electrical connection area | Including PV terminals, AC terminals, grounding terminals, communication terminals, etc. |

2.3.1 Dimensions

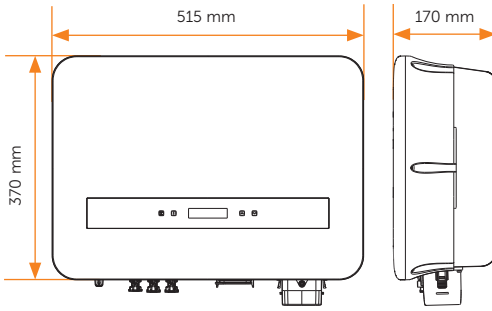

Figure 2-4 Dimensions

2.3.2 Control Panel

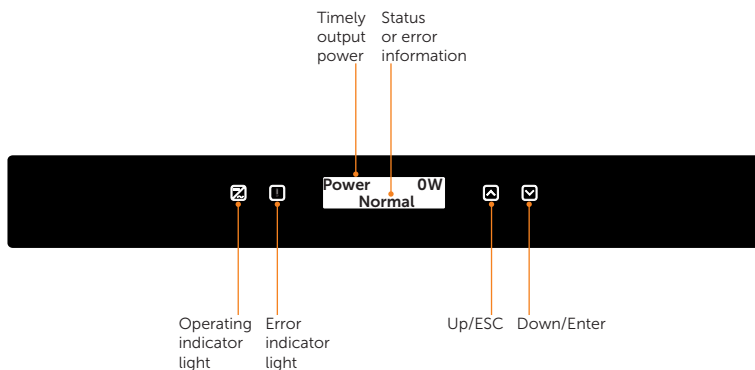

Figure 2-5 Control Panel

- In a normal state, the "Power" / "Pgrid" / "Today" / "Total" information will be displayed respectively. You can press the keys to switch information.
- In an error state, the fault message and error code will be displayed, please refer to corresponding solutions in the ["11.2 Troubleshooting"](#).

Table 2-2 Definition of indicators







| LED indicator | Status | Definition |
|--|---|-------------------------------------|
|  Operating |  Solid blue | The inverter is in a normal state. |
| |  Blue blinking | The inverter is in a waiting state. |
|  Error |  Solid red | The inverter is in a fault state. |

Table 2-3 Definition of keys

| Key | Definition |
|---|--|
|  | Short press: Up, move the cursor to the upper part or increase the value. Long press: ESC, exit from the current interface or function, or confirm the function setting to take effect. |
|  | Short press: Down, move the cursor to the lower part or decrease the value. Long press: Enter, confirm the selection or value change. |

2.3.3 Terminals of Inverter

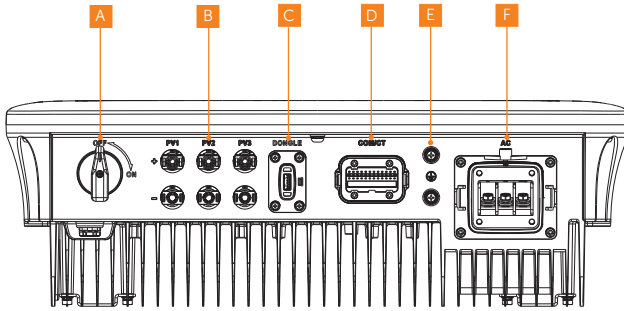













Figure 2-6 Terminals of Inverter

Table 2-4 Description of terminals

| Item | Description |
|------|------------------------------------|
| A | DC switch |
| B | PV connection port |
| C | Monitoring connection/Upgrade port |
| D | COM/CT port |
| E | Ground connection port |
| F | AC connection port |

2.3.4 Symbols on the Label and Inverter

Table 2-5 Description of symbols

| Symbol | Description |
|---|---|
|  | CE mark. The inverter complies with the requirements of the applicable CE guidelines. |
|  | TUV certified. |
|  | RCM mark. The inverter complies with the requirements of the applicable RCM guidelines. |
|  | Additional grounding point |
|  | Beware of hot surface. Do not touch a running inverter, as the inverter becomes hot during operation! |
|  | Risk of electric shock. High voltage exists after the inverter is powered on! |
|  | Risk of danger. Potential hazards exist after the inverter is powered on! |
|  | Observe enclosed documentation. |
|  | The inverter can not be disposed together with the household waste. |
|  | Do not operate this inverter until it is isolated from mains and on-site PV generation suppliers. |
|  | Danger to life due to high voltage. Residual voltage exists after the inverter is powered off, which needs 5 minutes to fully discharge. Wait 5 minutes before attempting any service. |

2.4 Circuit Principle Diagram

The inverter is equipped with multi-channel MPPT for DC input to ensure maximum power even under different photovoltaic input conditions. The inverter unit converts DC into AC that meets the requirements of the power grid and feeds it into the power grid. The lightning arrester at AC / DC side can realize the function of surge protection. The principle design of the inverter is shown in the figure below:

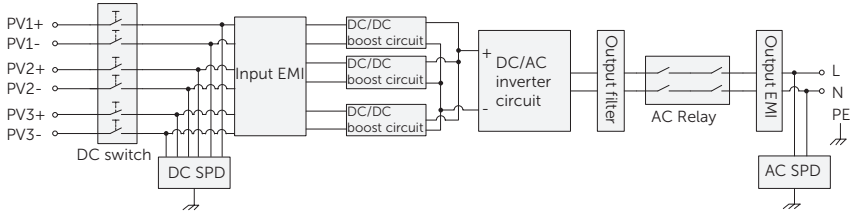

Figure 2-7 Circuit Diagram

3 Transportation and Storage

If the inverter is not put into use immediately, the transportation and storage requirements needs to be met:

Transportation

- Observe the caution signs on the packaging of the inverter before transportation.
- Pay attention to the weight of the inverter. Be cautious to avoid injury when carrying the inverter (gross weight: 23 kg).
- Wear protective gloves when carrying the equipment by hand to prevent injuries.
- When lifting up the inverter, hold the handle position of the inverter. Keep the inverter horizontal in case of falling down due to tilt.

Storage

- The inverter must be stored indoors.
- Do not remove the original packaging material and check the outer packaging material regularly.
- The storage temperature should be between -30°C and +70°C. The humidity should be between 0% and 65%.
- Stack the inverter in accordance with the caution signs on the inverter carton to prevent their falling down and device damage. Do not place it upside down.
- If the inverter has been stored for more than 1 year, it must be checked and tested by professionals before use.

4 Preparation before Installation

4.1 Selection of Installation Location

The installation location selected for the inverter is quite critical in the aspect of the guarantee of machine safety, service life and performance.

- It has the IP66 ingress protection, which allows it to be installed outdoor;
- The installation position shall be convenient for wiring connection, operation and maintenance.

4.1.1 Environment Requirement

Make sure the installation site meets the following conditions:

- The ambient temperature: -25°C to $+60^{\circ}\text{C}$;
- The humidity shall be between 0-100%;
- Do not install the inverter in the areas where the altitude exceeds 4000 m;
- Install the inverter in a well-ventilated environment for heat dissipation;
- Do not install the inverter in areas with flammable, explosive and corrosive materials;
- Do not install the inverter in areas near combustibles and antenna;
- You are recommended to install an awning over it. Direct sunlight, rain exposure and snow laying up is not allowed;

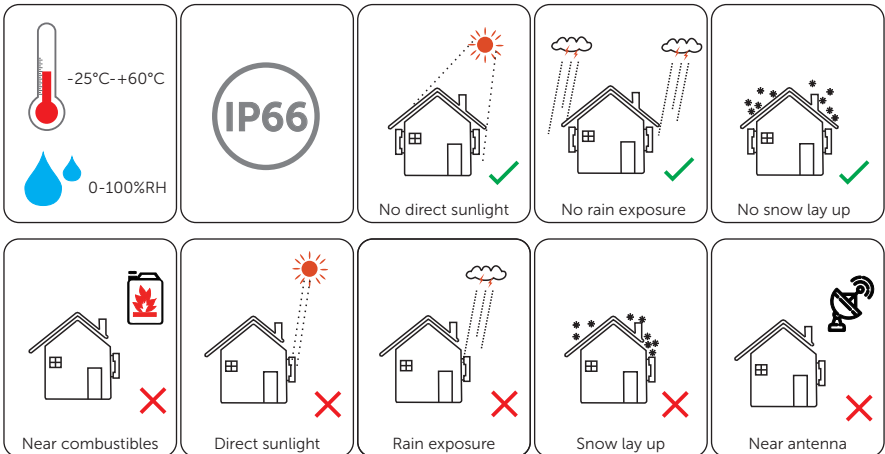

- Install the inverter 500 meters away from sea and at the place where the sea breeze does not directly hit.

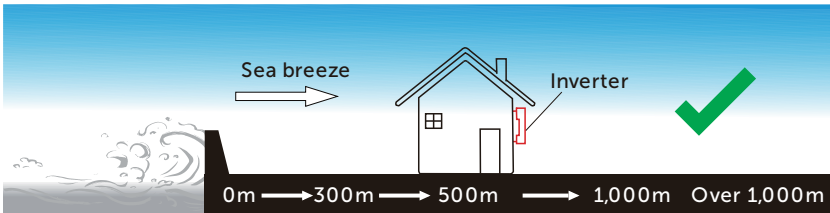

Figure 4-1 Recommended installation position

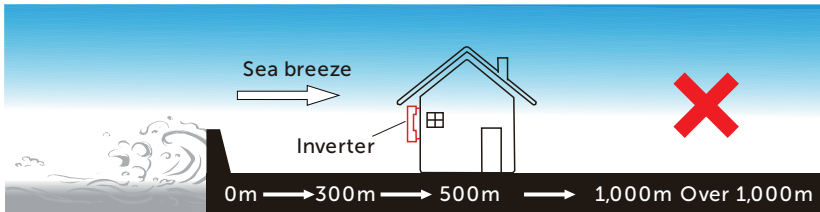

Figure 4-2 Incorrect installation position

4.1.2 Installation Carrier Requirement

The mounting location must be suitable for the weight and dimensions of the product and the support surface for installation must be made of a non-flammable material.

- Solid brick/concrete, or mounting surface with equivalent strength;
- The inverter must be supported or strengthened if the wall strength is not enough (such as wooden wall, the wall covered by thick layer of decoration).

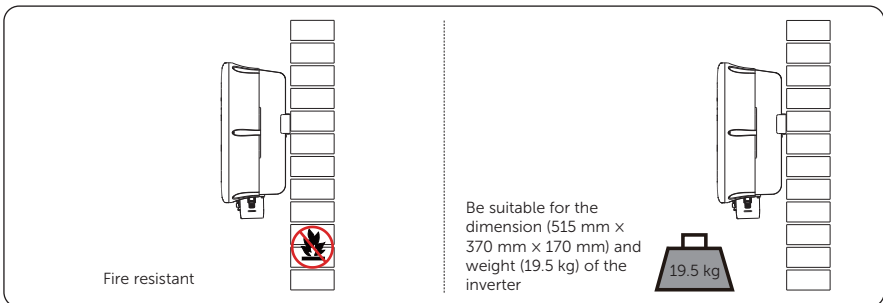

Figure 4-3 Installation carrier requirement

4.1.3 Clearance Requirement

To guarantee proper heat dissipation and ease of disassembly, the minimum space around the inverter must meet the standards indicated below.

For installations with multiple inverters, make sure to leave a minimum space of 35 cm between each inverter and 30 cm from the ceiling, and 30 cm above the ground. In areas with high ambient temperatures, increase the clearances between the inverters and provide adequate fresh air ventilation if feasible.

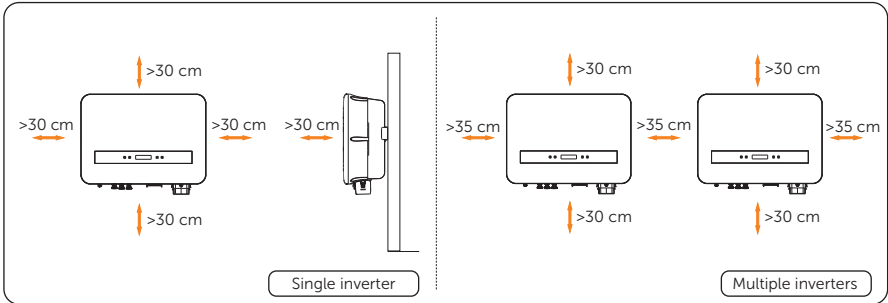
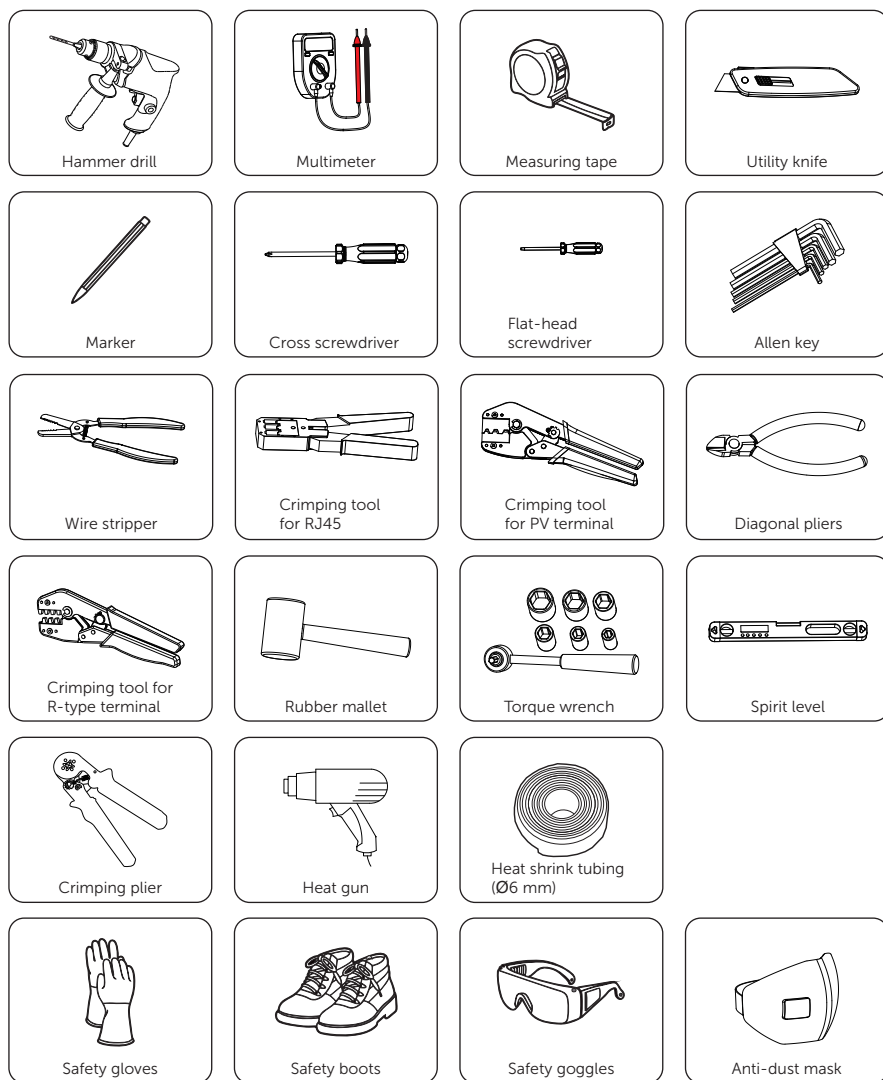

Figure 4-4 Clearance requirement







4.2 Tools Requirement

Installation tools include but are not limited to the following recommended ones. If necessary, use other auxiliary tools on site.



4.3 Additionally Required Materials

Table 4-1 Additionally required wires

| No. | Required Material | Type | Conductor Cross-section |
|-----|---|--|--------------------------|
| 1 | AC circuit breaker  | 63 A | / |
| 2 | PV cable  | Dedicated PV wire withstand voltage 1000 V | 4 mm ² |
| 3 | AC cable  | Three-core copper wire | 8-10 mm ² |
| 4 | Communication cable |  Network cable CAT5 | 0.2 mm ² |
| | |  Two-core cable | Outer diameter: 5-6.5 mm |
| 5 | Additional PE cable  | Conventional yellow and green wire | 6 mm ² |

5 Unpacking and Inspection

5.1 Unpacking

- The inverter undergoes 100% testing and inspection before shipping from the manufacturing facility. However, transport damage may still occur. Before unpacking the inverter, please verify that the model and outer packing materials for damage, such as holes and cracks.
- Unpacking the inverter according to the following figure.

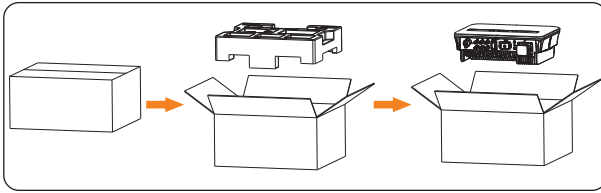

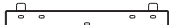













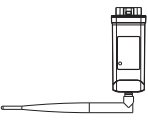
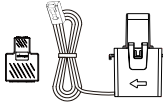

Figure 5-1 Unpacking the inverter

- Be careful when dealing with all package materials which may be reused for storage and relocation of the inverter in the future.
- Upon opening the package, check whether the appearance of the inverter is damaged or lack of accessories. If any damage is found or any parts are missing, contact your dealer immediately.

5.2 Scope of Delivery

| | | | |
|---|--|--|---|
|  <p>Inverter x 1</p> |  <p>Bracket x 1</p> |  <p>Expansion tube x 3</p> |  <p>Self-tapping screw x 3</p> |
|  <p>Washer x 3</p> |  <p>M5 screw x 1</p> |  <p>R-type terminal for PE connection x 2</p> |  <p>AC waterproof cover x 1</p> |
|  <p>Spacer for AC connection x 2</p> |  <p>R-type terminal for AC connection x 3</p> |  <p>PV connector x 3 pairs</p> |  <p>PV pin contact x 3 pairs</p> |
|  <p>Communication connector x 1</p> |  <p>Cord end terminal x 20</p> |  <p>RJ45 terminal x 2</p> |  <p>Documents</p> |
|  <p>Dongle (Optional) x 1</p> |  <p>RJ45 coupler (Optional) x 1; CT (Optional) x 1</p> | | |

NOTICE!

- Refer to the actual delivery for the optional accessories.

6 Mechanical Installation

WARNING!

- Only the qualified personnel can perform the mechanical installation following the local standards and requirements.
- Check the existing power cables or other piping in the wall to prevent electric shock or other damage.

CAUTION!

- Always be aware of the weight of the inverter. Personal injuries may result if the inverter is lifted improperly or dropped while being transported or mounted.
- Use insulated tools and wear individual protective tools when installing the inverter.

NOTICE!

- Install the inverter at a maximum back tilt of 5 degrees and avoid forward tilted, side tilted, or upside down.

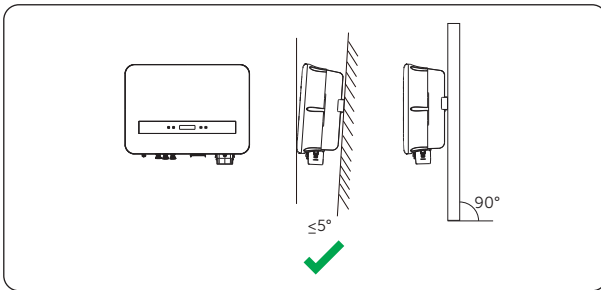

Figure 6-1 Correct installation

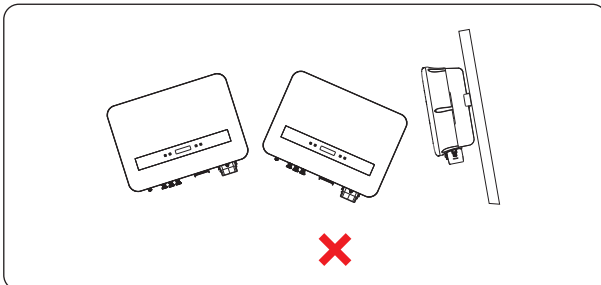

Figure 6-2 Incorrect installation

Installation procedures

Step 1: Align the wall mounting bracket horizontally on the wall and mark the position of the drill holes.

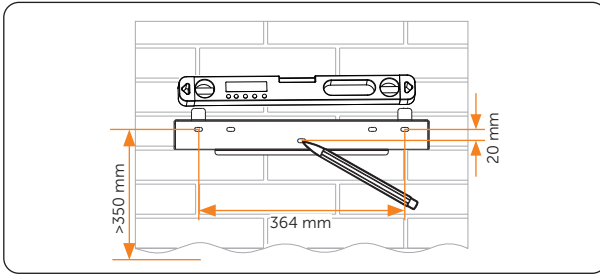

Figure 6-3 Marking the holes

NOTICE!

- Observe the bubble of the spirit level and adjust the wall bracket until the bubble stays in the middle.

Step 2: Set the wall bracket aside and drill holes with $\varnothing 10$ drill. The depth of the holes should be at least 60 mm.

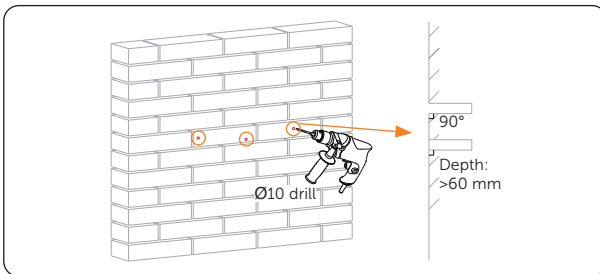

Figure 6-4 Drilling holes

NOTICE!

- Do cover the inverter before drilling holes and clean up any dust in and around the holes using dust collector.

Step 3: Insert the expansion tubes into the holes.

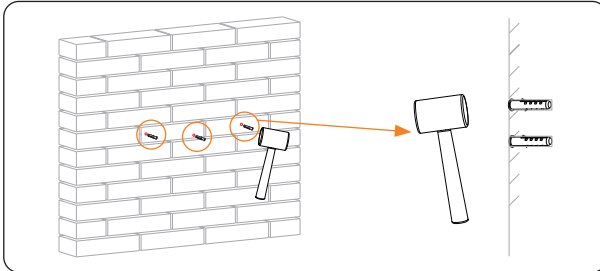

Figure 6-5 Inserting the expansion tubes

Step 4: Secure the bracket to the wall with expansion screws and washers.

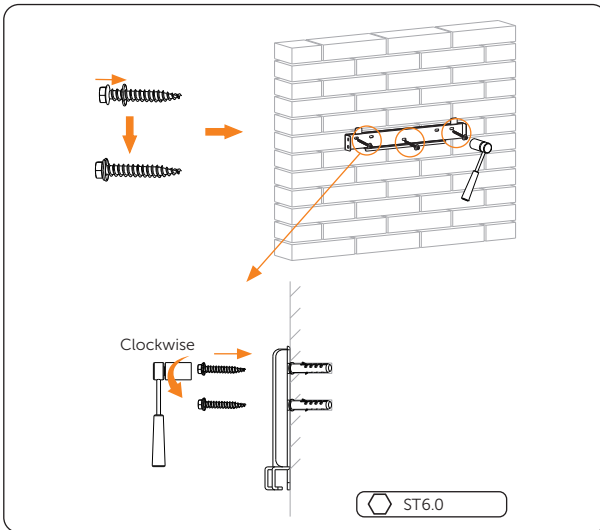

Figure 6-6 Securing the bracket

Step 5: Open the anti-static bag and take out the machine.

NOTICE!

- If the inverter is temporarily needed to be placed on the ground, use foam or other protective materials to prevent any damage of inverter.

Step 6: Lift up the inverter and hang it on the wall bracket. The buckles on the back of the inverter must be hooked into the keyways of the wall bracket.

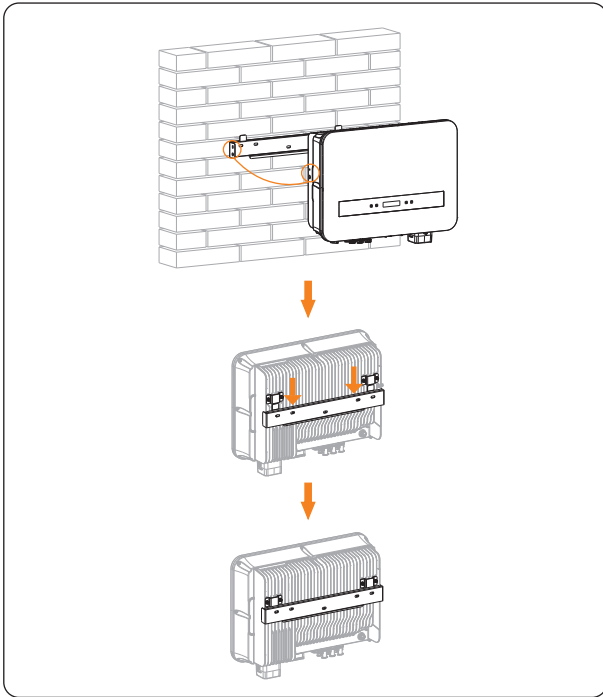

Figure 6-7 Lifting up and hanging the inverter

Step 7: Secure the inverter to the wall mounting bracket on left side with the M5 screw.

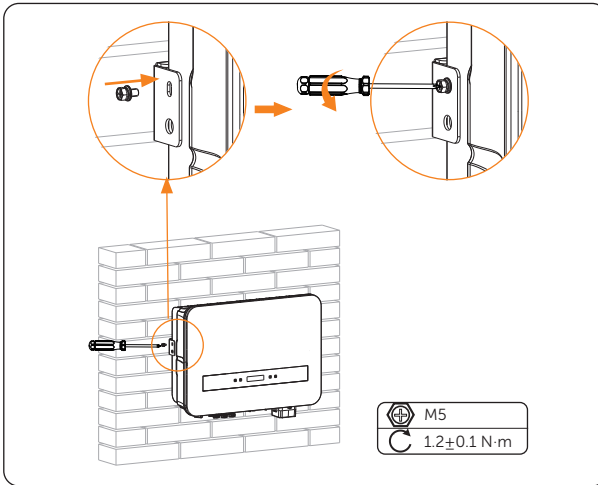

Figure 6-8 Securing the inverter

Step 8: (Optional) For safety reason, install an anti-theft lock. Please note that the lock is not in the scope of delivery. Prepare it suitable for the lock hole diameter (Ø10 mm) by yourself. Keep the key to the lock in a safe place.

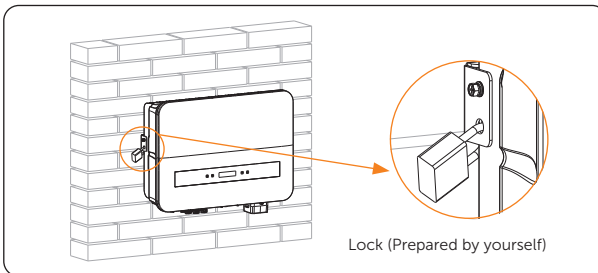

Figure 6-9 Locking the inverter

7 Electrical Connection

DANGER!

- Before electrical connection, make sure the DC switch and AC breaker are disconnected. Otherwise, electrical shock may be caused by high voltage, resulting in serious personal injury or death.

WARNING!

- Only the qualified personnel can perform the electrical connection following the local standards and requirements.
- Follow this manual or other related document to wire connection. The device damage caused by incorrect cabling is not in the scope of warranty.

CAUTION!

- Use insulated tools and wear individual protective tools when connecting cables.

7.1 PE Connection

WARNING!

- Since the inverter is transformerless, neither the negative electrode nor the positive electrode of the PV string can be grounded.
- Before AC connection, PV connection, and communication connection, connect the grounding terminal to the external protective grounding point.
- The external protective grounding point provides a reliable ground connection. Do not use an improper grounding conductor, or it may cause product damage or personal injury.

WARNING!

The external protective grounding terminal must meet at least one of the following requirements.

- If the conductor cross-section of the PE cable is not less than 10 mm² for copper wire or 16 mm² for aluminum wire, it is recommended that both the external protective grounding terminal and the grounding terminal on the AC side be reliably grounded.
- If the conductor cross-section of the PE cable is less than 10 mm² for copper wire or 16 mm² for aluminum wire, ensure that both the external protective grounding terminal and the grounding terminal on the AC side are reliably grounded.

All non-current carrying metal parts of the equipment and other enclosures in the PV system must be grounded reliably. We recommend that the inverter be earthed to a nearby ground point. For a system with multiple inverters connected in parallel, connect the ground points of all inverters to ensure equipotential connections to ground cables.

PE connection procedures

Step 1: Strip the insulation jacket of the conductor by wire stripper.

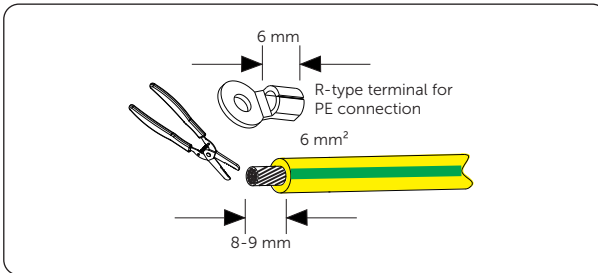

Figure 7-1 Stripping the PE cable

Step 2: Pull the heat shrink tubing over the PE cable and insert the stripped section into the R-type terminal for PE connection.

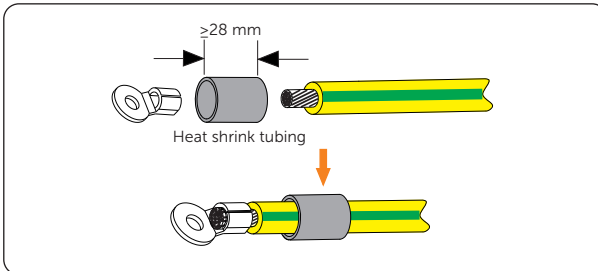

Figure 7-2 Installing the tubing and terminal

Step 3: Crimp it with crimping tool for R-type terminal, pull the heat shrink tubing over the crimped section of the R-type terminal for PE connection and use a heat gun to shrink it so that it can be firmly contacted with the terminal.

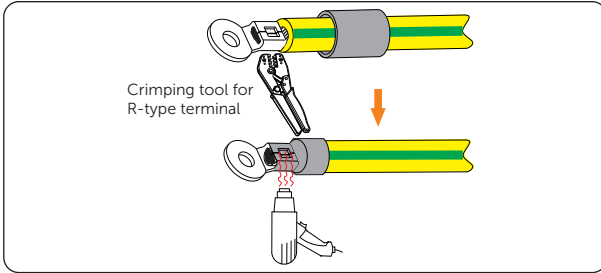

Figure 7-3 Crimping the cable

Step 4: Remove the two M5 screws from the ground connection ports of the inverter.

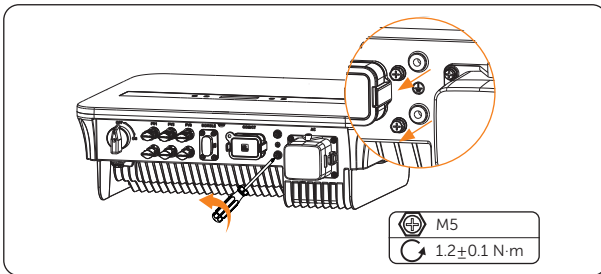

Figure 7-4 Removing the M5 screws

Step 5: Connect the PE cables to the inverter and secure them with cross screwdriver.

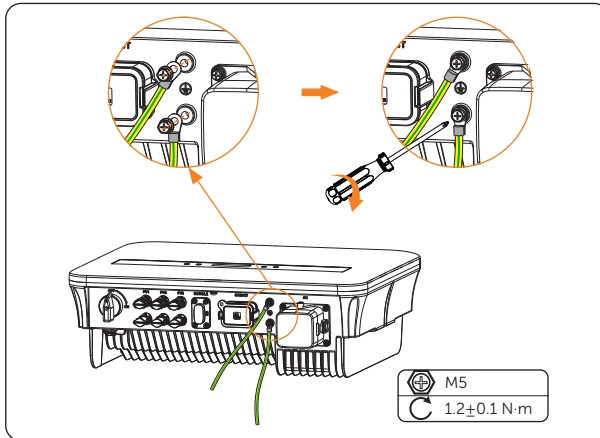

Figure 7-5 Securing the PE cable

Earth Fault Alarm

In compliance with the section 13.9 of IEC62109-2, the series inverter is equipped with an earth fault alarm. When **Earth Detect** function is enabled, if the the inverter is not connected with earth, the inverter will turn on a red light and report **EarthFault**.

7.2 AC Connection

NOTICE!

- Before connecting the inverter to the grid, approval must be received by local utility as required by national and state interconnection regulations.

Requirements for AC side connection

- Grid Voltage requirement
 - » The grid voltage must be within the permissible range. The inverter is suitable for rated voltage 220/230/240 V, frequency 50/60 Hz. Other technical requests should comply with the requirement of the local public grid.
- RCD requirement
 - » The inverter does not require an external residual-current device when operating. If an external RCD is required by local regulations, it is recommended to use a Type-A RCD with the value of 300 mA.
- AC breaker requirement
 - » An AC breaker that matches the power of the inverter must be connected between the inverter output and the power grid, and each inverter must be equipped with an independent breaker or other load disconnection unit to ensure the safe disconnection from the grid. Refer to "[4.3 Additionally Required Materials](#)" for specific data.
- Load requirement
 - » It is prohibited to connect any load between the inverter and the AC breaker.

Wiring procedures

Step 1: Fetch the AC waterproof cover from accessory bag. Take out the sealing ring A from inside the cover, loosen the swivel nut from the cover, and disassemble it as shown below.

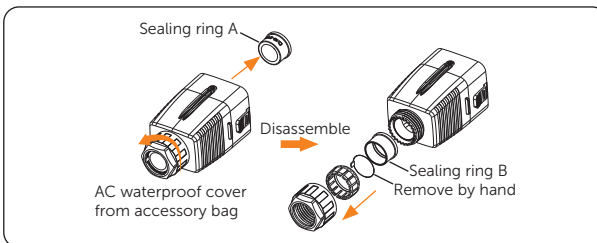

Figure 7-6 Disassembling the AC waterproof cover

- Step 2:** Select appropriate sealing ring according to the outer diameter of the prepared AC cable. Thread the AC cable as shown below.

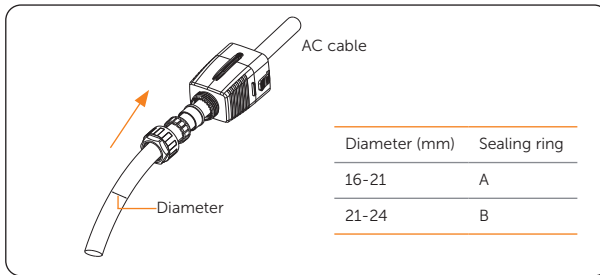

Figure 7-7 Threading the AC cable

- Step 3:** Strip the insulation jacket of L, N and PE wires of the AC cable by wire stripper as below. Then pull the heat shrink tubing over the wires and insert the stripped sections into the R-type terminals for AC connection.

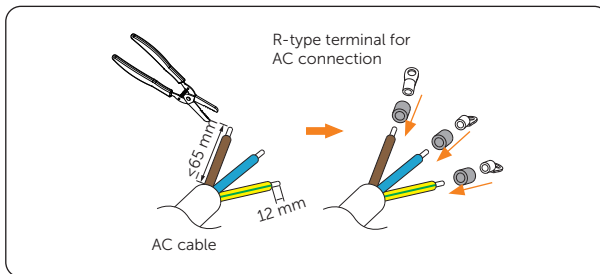

Figure 7-8 Stripping and inserting the wires of the AC cable

- Step 4:** Crimp the terminals with crimping tool for R-type terminal, pull the heat shrink tubing over the crimped sections of the R-type terminals for AC connection and use a heat gun to shrink it so that it can be firmly contacted with the terminals.

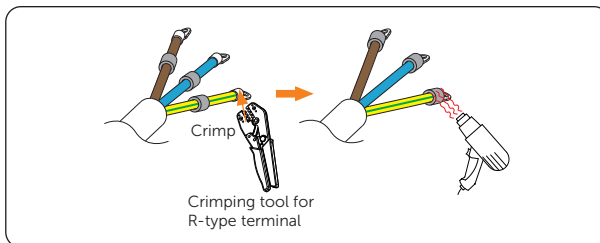

Figure 7-9 Crimping the AC cable end

Step 5: Remove the dust cover from AC connection port.

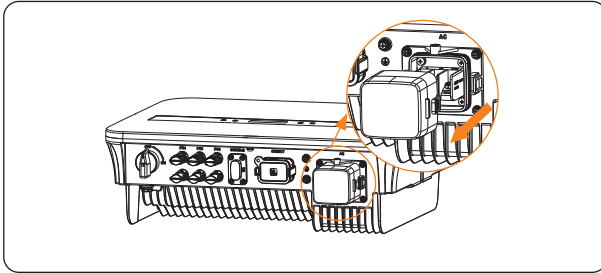

Figure 7-10 Removing the dust cover

Step 6: Install the two spacers for AC connection on the inverter as shown below.

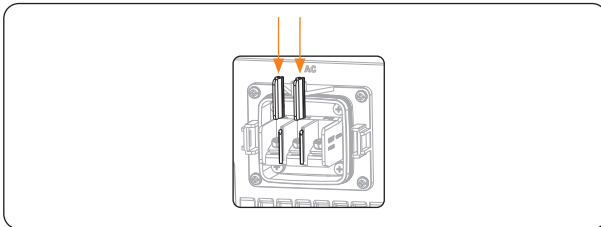

Figure 7-11 Installing the spacers

Step 7: Take down the screws on the AC connection port of the inverter.

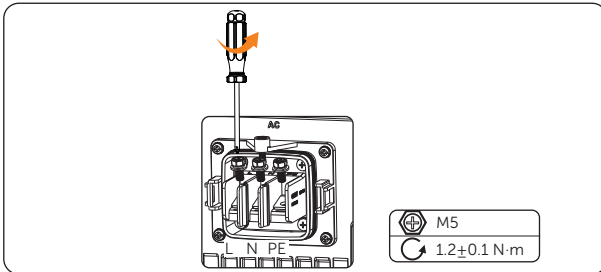

Figure 7-12 Taking down the screws

Step 8: Connect the L, N and PE wires to the inverter and align the screws, please note to keep the side of the AC waterproof cover shown below outwards.

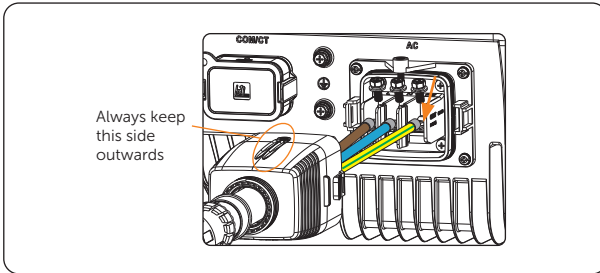

Figure 7-13 Connecting the wires and aligning the screws

Step 9: Tighten the screws to secure the wires.

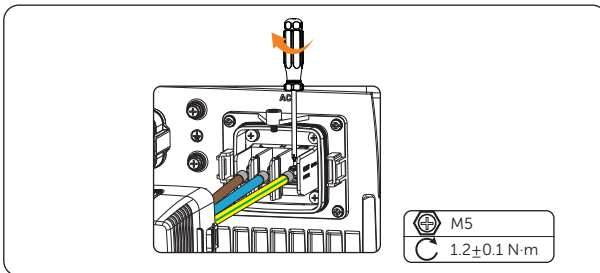

Figure 7-14 Tightening the screws

Step 10: Align the AC waterproof cover with the AC connection port of the inverter, a "click" sound will be heard when the cover is correctly seated.

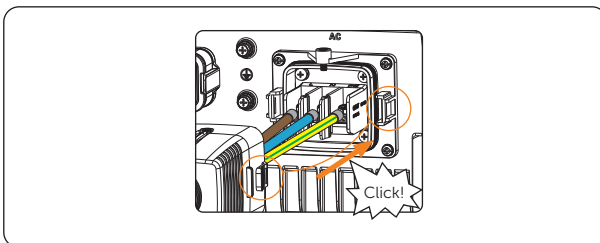

Figure 7-15 Aligning the AC waterproof cover

Step 11: Fasten the swivel nut of the AC waterproof cover and use a cross screwdriver to secure the cover.

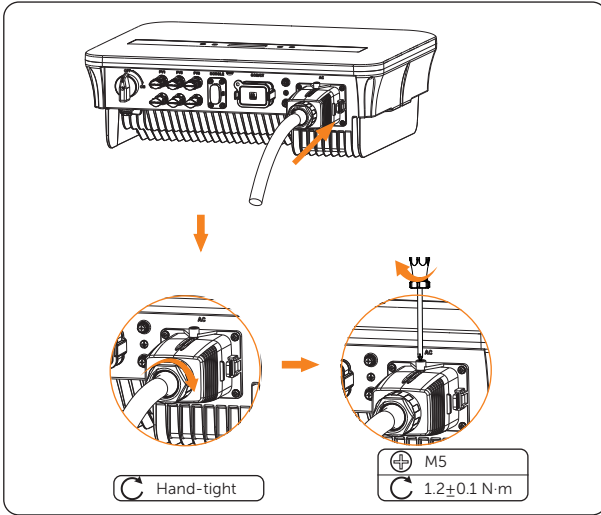

Figure 7-16 Fastening and securing the AC waterproof cover

7.3 PV Connection

DANGER!

- High DC voltage will be generated by PV modules when exposed to sunlight. Death or lethal injuries will occur due to electric shock.
- Make sure the DC switch are turned off and AC breaker are disconnected from the inverter before connection and no live voltages are present on the PV input and AC output circuit.
- Make sure that the PV module output is well insulated to ground.

CAUTION!

- Power is fed from more than one source and more than one live circuit. Note that all DC and AC terminals may carry current even without connected wires.

Requirements for PV connection

- Open circuit voltage
 - » The open circuit voltage of each module array cannot exceed the maximum PV input voltage (600 V) of the inverter. Otherwise, the inverter may be damaged.
 - » The operating voltage of PV modules must be within the MPPT voltage range (40-560 V) of the inverter. Otherwise, the inverter will prompt **PvVoltFault** alarm.
- PV module
 - » All PV modules should be of the same type, same model, same number, aligned and tilted identically.
 - » The positive or negative pole of the PV modules is not grounded.
 - » The positive cables of the PV modules must be connected with positive DC connectors. The negative cables of the PV modules must be connected with negative DC connectors.

Wiring procedures

Step 1: Strip approx. 7 mm of the cable insulation jacket.

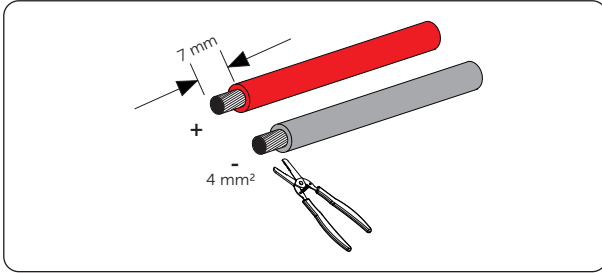

Figure 7-17 Stripping the PV cables

Step 2: Insert the stripped ends of the PV cables into the PV pin contacts. Ensure that the stripped cable and the PV pin contact are of the same polarity.

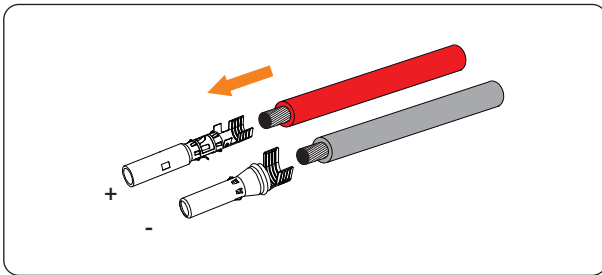

Figure 7-18 Inserting into the PV pin contacts

Step 3: Crimp them with crimping tool for PV terminal. When crimping the positive pin contact, please pay special attention to the part to be crimped.

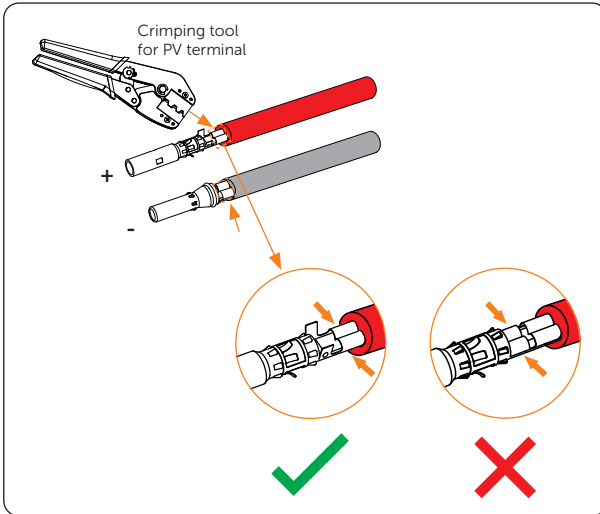

Figure 7-19 Crimping the PV cables with pin contacts

Step 4: Loosen the swivel nuts from the PV connectors and thread the PV cables through swivel nuts and connectors.

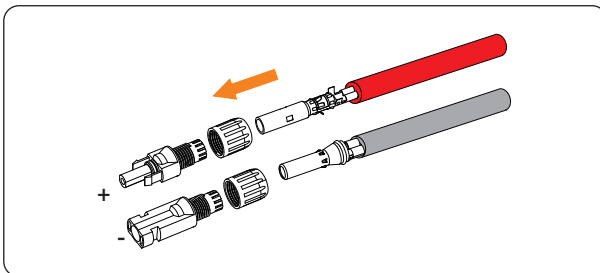

Figure 7-20 Threading the PV cable

Step 5: Insert the cables into the PV connectors until a "click" sound is heard. Gently pull the cables backward to ensure firm connection.

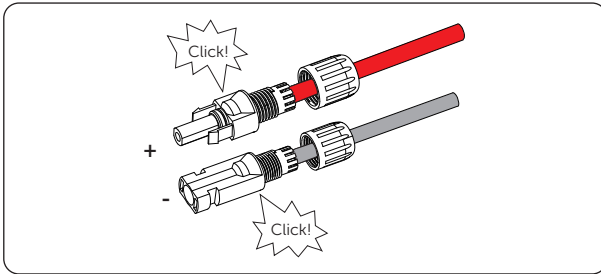

Figure 7-21 Securing PV cables

Step 6: Tighten the swivel nuts clockwise.

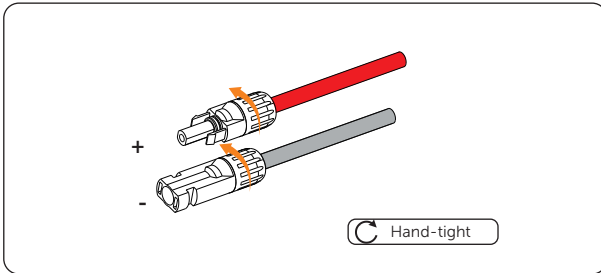

Figure 7-22 Tightening swivel nuts of PV connectors

Step 7: Check whether the PV connectors have the correct polarity. Use a multimeter to measure the positive and negative voltage of the assembled PV connectors. Make sure the open circuit voltage does not exceed the input limit of 600 V.

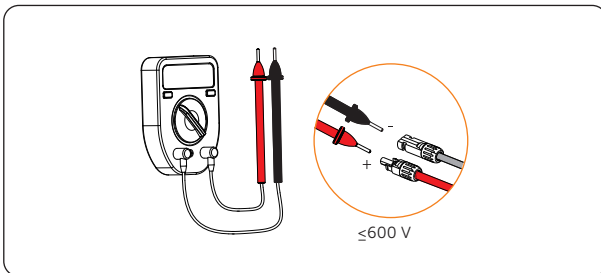

Figure 7-23 Measuring the voltage of PV connectors

NOTICE!

- If the voltage is a negative value, the DC input polarity is incorrect. You need to correct the positive and negative polarity.
- If the measured voltage exceeds 600 V, too many PV modules are configured to the same string. Remove some PV modules.

Step 8: Remove the PV terminal caps.

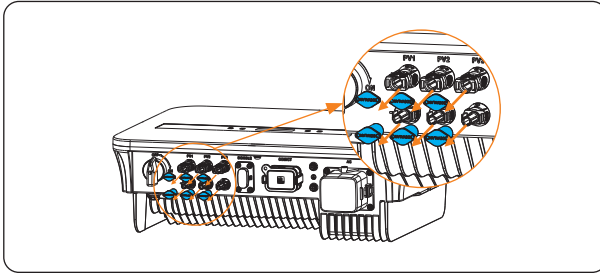

Figure 7-24 Removing the caps

Step 9: Connect the assembled PV connectors to corresponding terminals until there is an audible click. The PV+ on the string side must be connected to the PV+ on the inverter side, and the PV- on the string side must be connected to the PV- on the inverter side. Seal the unused PV terminals with original terminal caps.

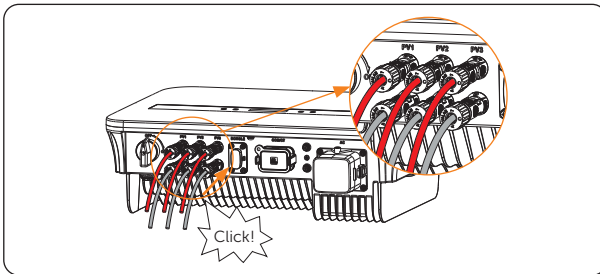

Figure 7-25 Connecting the PV cables

7.4 Communication Connection

The inverter provides a COM/CT port, through this port the inverter can communicate with a computer, Datahub, meter, CT or other devices to achieve various functions.

7.4.1 Wiring Procedures

Step 1: Fetch the communication connector from the accessory bag, and disassemble it.

- a. Loosen the swivel nut from the communication connector.

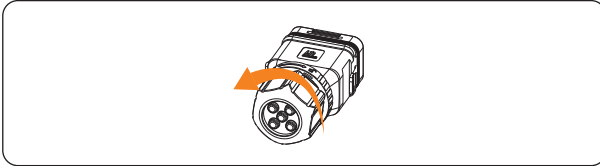

Figure 7-26 Loosening the swivel nut

- b. Take out the stopper and press the part as shown below on both sides and pull the terminal block out.

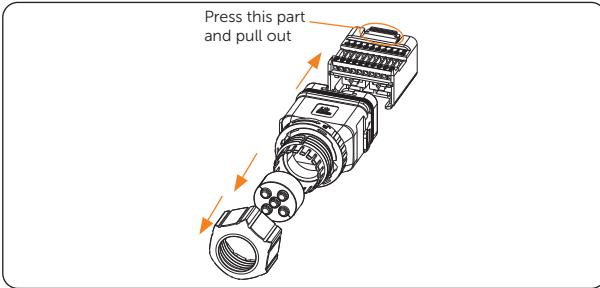

Figure 7-27 Disassembling the connetor

- c. Remove the waterproof plugs based on actual needs.

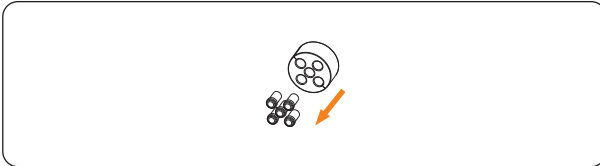

Figure 7-28 Removing the waterproof plugs

Pin Definitions

The terminal block can be divided into three sections. Section A is for connecting meter or CT, section B is for connecting DRM and section C can be used to connect computer, datahub, meter, CT or other devices.

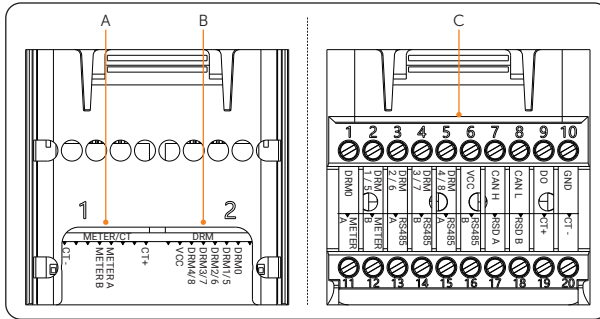

Figure 7-29 Sections of the terminal block

Table 7-1 Pin Definition of Section A (METER/CT)

| Pin | 1 | 2 | 3 | 4 | 5 | 6 | 7 | 8 |
|----------------|-----|---|---|---------|---------|---|---|-----|
| Pin Definition | CT+ | X | X | METER A | METER B | X | X | CT- |

Table 7-2 Pin Definition of Section B (DRM)

| Pin | 1 | 2 | 3 | 4 | 5 | 6 | 7 | 8 |
|----------------|---|------|--------|--------|--------|--------|-----|---|
| Pin Definition | X | DRM0 | DRM1/5 | DRM2/6 | DRM3/7 | DRM4/8 | VCC | X |

Table 7-3 Pin Definition of Section C

| Pin | Pin Definition | Pin | Pin Definition |
|-----|----------------|-----|----------------|
| 1 | DRM0 | 11 | METER A |
| 2 | DRM1/5 | 12 | METER B |
| 3 | DRM2/6 | 13 | RS485 A |
| 4 | DRM3/7 | 14 | RS485 B |
| 5 | DRM4/8 | 15 | RS485 A |
| 6 | VCC | 16 | RS485 B |
| 7 | CAN H | 17 | RSD A |
| 8 | CAN L | 18 | RSD B |
| 9 | DO | 19 | CT+ |
| 10 | GND | 20 | CT- |

NOTICE!

- When connecting with meter or CT, users can connect via either section A (recommended) or section C.
- When connecting with DRM, users can connect via either section B (recommended) or section C. For DRM, only DRM 0 is available now.

Step 2: Prepare and make the communication cable(s) according to the actual application scene.

If connect via section A/B (Use network cable CAT5)

- Thread the communication cable (network cable CAT5) through the swivel nut, the stopper, and the communication connector.
- If the communication cable is without RJ45 terminal, thread the cable through whichever hole of the stopper and strip 15 mm of the insulation jacket. Then insert the stripped part into the RJ45 terminal and crimp it with a crimping tool for RJ45.

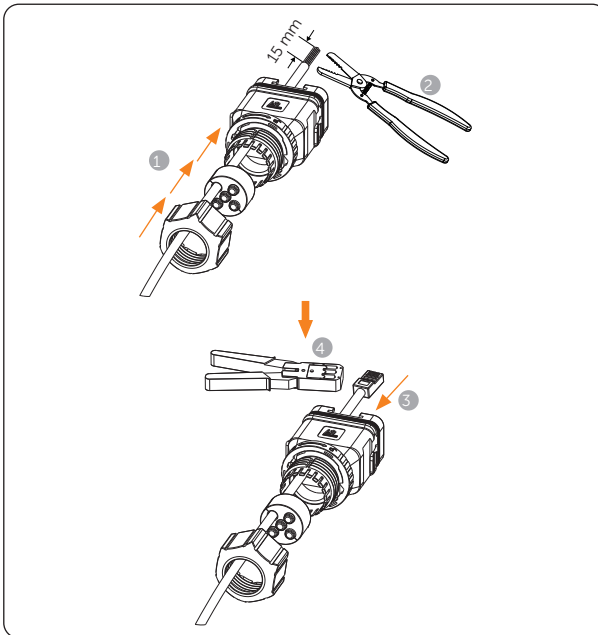

Figure 7-30 Threading communication cable without RJ45 terminal

- If the communication cable is with RJ45 terminal, thread the cable through one of the holes with an opening of the stopper.

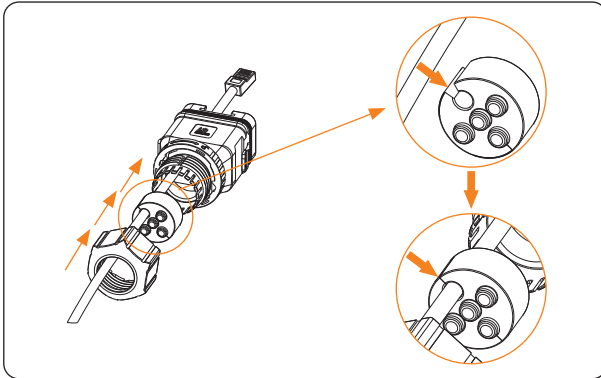

Figure 7-31 Threading communication cable with RJ45 terminal

- b. Insert the RJ45 terminal to section A or B of the terminal block according to actual application.

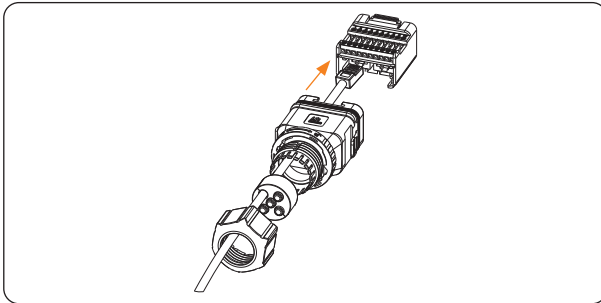

Figure 7-32 Inserting the RJ45 terminal to the terminal block

- c. Pull the terminal block back to the connector until a "click" sound is heard. Then pull the stopper and the swivel nut back.

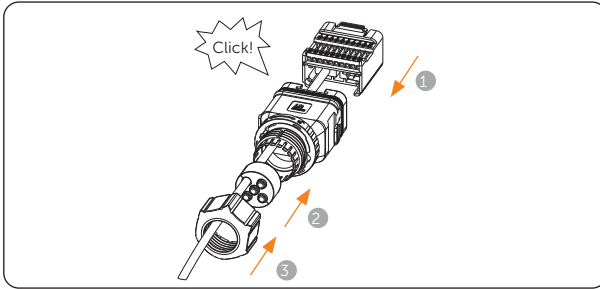

Figure 7-33 Pulling the materials back

- d. Tighten the swivel nut until a "click" sound is heard, at which time the lock of the communication connector will be locked automatically.

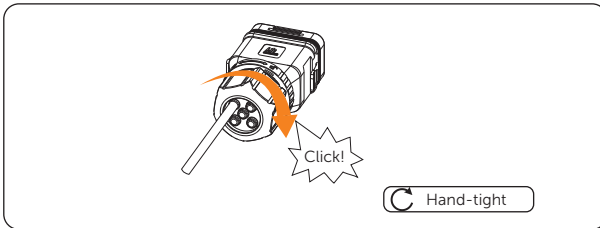

Figure 7-34 Tightening the swivel nut

If connect via section C (Use two-core cable)

- a. Strip the two-core communication cable as shown below according to the actual application.

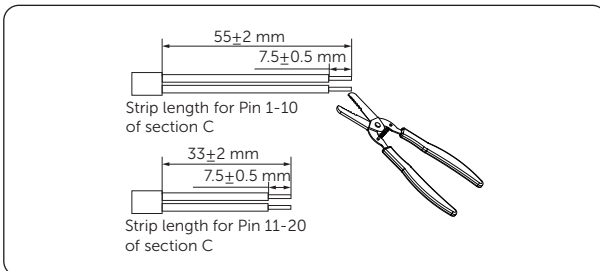

Figure 7-35 Stripping the two-core communication cable

- b. Put the cord end terminals on the stripped parts of the cable end and use a crimping plier to ensure the wires are securely in place.

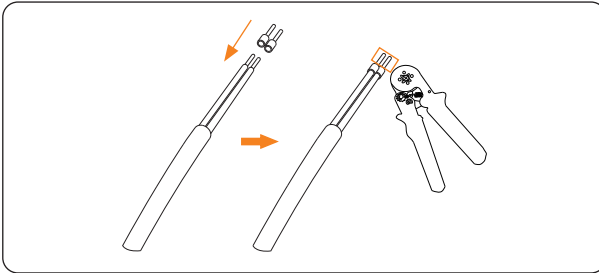

Figure 7-36 Crimping the cable end

- c. Insert the crimped parts to the correct pins following the pin definitions.

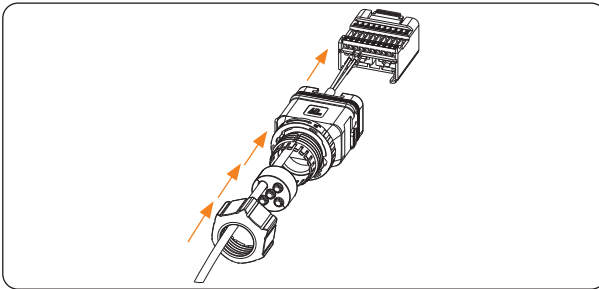

Figure 7-37 Inserting the crimped parts to the correct pins

- d. Secure the screws with a flat-head screwdriver.

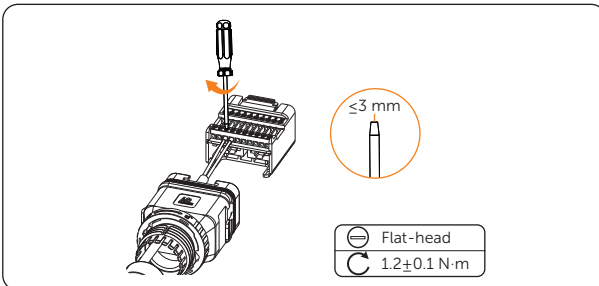

Figure 7-38 Securing the two-core cable

- e. Pull the terminal block back to the connector until a "click" sound is heard. Then pull the stopper and the swivel nut back.

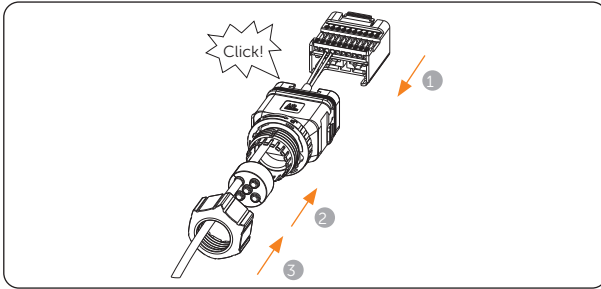

Figure 7-39 Pulling the materials back

- f. Tighten the swivel nut until a "click" sound is heard, at which time the lock of the communication connector is locked automatically.

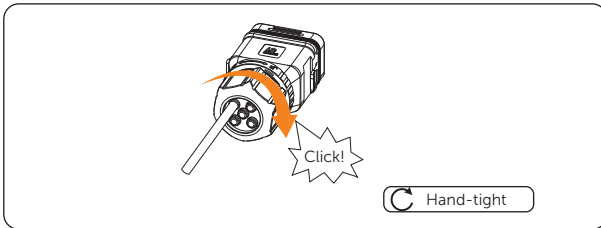

Figure 7-40 Tightening the swivel nut

* If the communication connector needs to be re-disassembled, please turn the lock in the middle part of the connector to the right side with one hand and maintain the force while rotating the swivel nut anti-clockwise with the other hand at the same time.

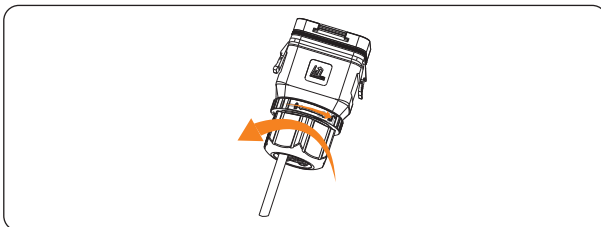

Figure 7-41 Re-disassemble the communication connector

Step 3: Connect the communication connector to the inverter.

- a. Remove the dust cover from the COM/CT port of the inverter.

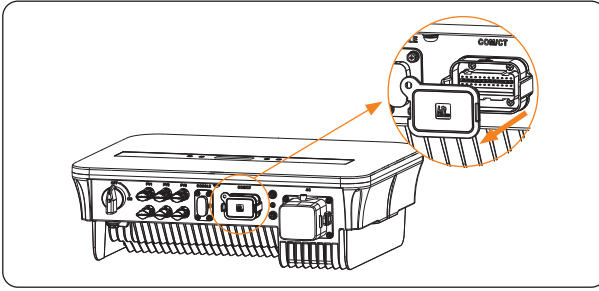

Figure 7-42 Removing the dust cover from the COM/CT port

- b. Connect the communication connector to the inverter. Please note to keep the side shown as below outwards, and press the two parts when aligning to the COM/CT port of the inverter.

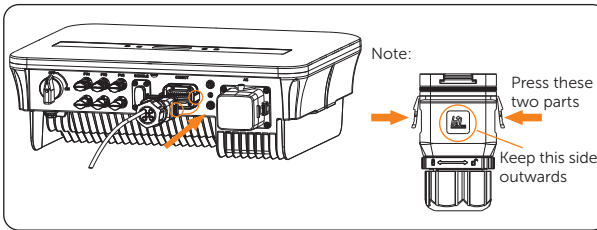

Figure 7-43 Connecting the communication connector to the inverter

- c. It is well connected when a "click" sound is heard.

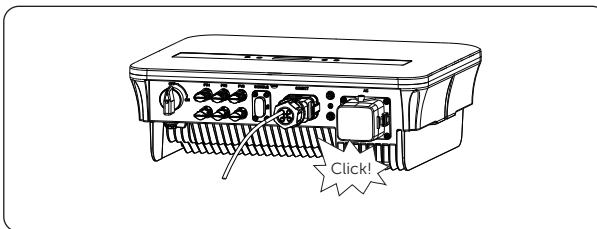

Figure 7-44 Communication connection completed

7.4.2 Meter/CT Connection

The inverter should work with an electric meter or current transformer (CT for short) to monitor household electricity usage. The electricity meter or CT can transmit the relevant electricity data to the inverter or platform, which is convenient for users to read it at anytime.

CAUTION!

- It is recommended to connect our smart meter or CT to the inverter. If there is no smart meter or CT installed, please disable the **Export Control** function in the inverter setting. Otherwise the inverter will shut down and report a **Meter Fault** alert. The **Export Control** is disabled by default, if an error occurs, please check if it is disabled.
- The smart meter must be purchased from and authorized by our company, any third party or non-authorized meter may be incompatible with the inverter.
- SolaX will not be responsible for the impact caused by the use of other appliances.

NOTICE!

- Do not place the CT on the N wire or ground wire.
- Do not put CT on the N wire and L wire at the same time.
- Do not place the CT on the side where the arrow points to the inverter.
- Do not place the CT on non-insulated wires.
- The cable length between CT and inverter should not exceed 100 meters.
- After CT is connected, prevent the CT clip from falling off.
- It is recommended to wrap the CT clip around in circles with insulating tape.

Connection Diagram

- Meter connection diagram

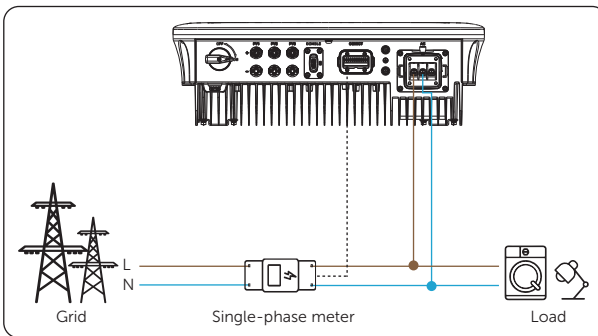

Figure 7-45 Meter connection diagram

- CT connection diagram

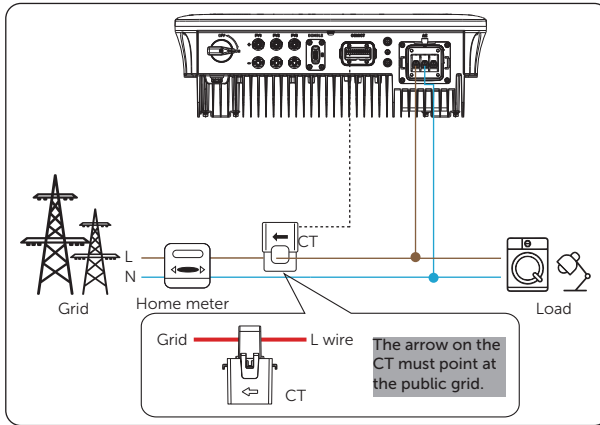

Figure 7-46 CT connection diagram

7.4.3 DRM Connection (Applicable to AS/NZS 4777.2)

According to AS/NZS 4777.2, the inverter needs to support the function of demand response mode (DRM), only DRM 0 is available now.

Table 7-4 Descriptions of DRM

| Mode | Requirement |
|-------|--|
| DRM 0 | Operate the disconnection device |
| DRM 1 | Do not consume power |
| DRM 2 | Do not consume at more than 50% of rated power |
| DRM 3 | Do not consume at more than 75% of rated power AND supply reactive power if capable |
| DRM 4 | Increase power consumption (subject to constraints from other active DRMs) |
| DRM 5 | Do not generate power |
| DRM 6 | Do not generate at more than 50% of rated power |
| DRM 7 | Do not generate at more than 75% of rated power AND absorb reactive power if capable |
| DRM 8 | Increase power generation (subject to constraints from other active DRMs) |

7.4.4 Parallel Connection

The series inverter provides the parallel connection function, which could support several inverters to parallel in one system and can control zero injection to the grid with a meter or CT installed in the main circuit.

Requirments for parallel connection

- All inverters are recommended to be of the same series.
- All inverters should be of the same software version.

NOTICE!

- When multiple inverters are to be connected in parallel on three-phase grid, it is recommended that the inverters be connected on different phases so that the power on different phases is distributed more evenly.
- We recommend that for a system with multiple inverters connected in parallel, connect the ground points of all inverters to ensure equipotential connections to ground cables.

The parallel system can be achieved with Modbus Function or with Datahub.

In the parallel system with Modbus Function, at most 5 inverters can be connected. One inverter will be set as a master, and the rest are the slaves. The master inverter can communicate with all the slave inverters.

In the parallel system with Datahub, at most 60 inverters can be connected. The Datahub will be the master of the system, and all the inverters are the slaves. The Datahub can communicate with all the slave inverters.

Please refer to the following diagrams.

Parallel connection diagram

- Diagram 1: parallel system with Modbus Function
 - » Use standard two-core cable for parallel connection.
 - » Master inverter one pair of pin RS485A & RS485B of COM/CT port to Slave 1 inverter one pair of RS485A & RS485B of COM/CT port.
 - » Slave 1 inverter another pair of pin RS485A & RS485B of COM/CT port to Slave 2 inverter one pair of RS485A & RS485B of COM/CT port; other inverters are connected in such way.
 - » Meter/CT connects to the master inverter.

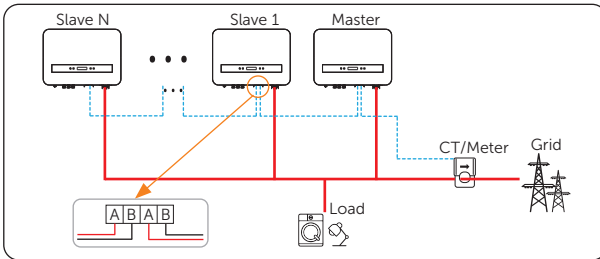

Figure 7-47 Parallel connection with Modbus Function

- Diagram 2: In the parallel system with Datahub
 - » Use standard two-core cable for parallel connection.
 - » Datahub RS485 to Slave 1 inverter one pair of RS485A & RS485B of COM/CT port.
 - » Slave 1 inverter another pair of pin RS485A & RS485B of COM/CT port to Slave 2 inverter one pair of RS485A & RS485B of COM/CT port; other inverters are connected in such way.
 - » Meter connects to Datahub.

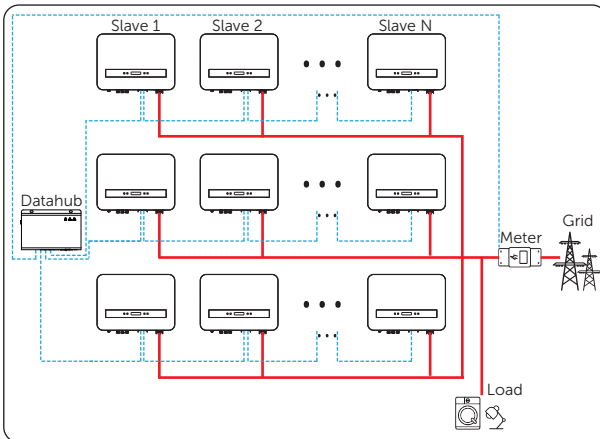

Figure 7-48 Parallel connection with Datahub

7.4.5 External Devices Connection

The inverter supports to communicate with external devices, such as Datahub, EV-Charger, Adapter Box etc via COM/CT port.

External connection with Datahub

- Pin assignment

| Section C of COM/CT port of the inverter | | RS485-1/-2/-3/-4 port of SolaX Datahub | |
|--|----------------|--|----------------|
| Pin | Pin definition | Pin | Pin definition |
| 13/15 | RS485A | / | A+ |
| 14/16 | RS485B | / | B- |

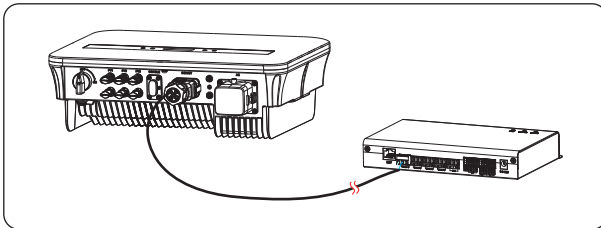

Figure 7-49 Inverter connected with Datahub

External connection with EV-Charger

- Connection diagram

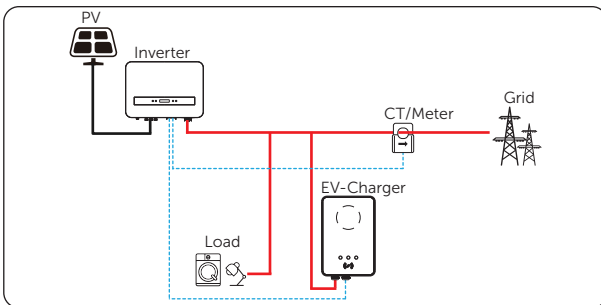

Figure 7-50 EV-Charger connection diagram

- Pin assignment

| Section C of COM/CT port of the inverter | | COM port of SolaX EV-Charger | |
|--|----------------|------------------------------|----------------|
| Pin | Pin definition | Pin | Pin definition |
| 13/15 | RS485A | 4 | A1 |
| 14/16 | RS485B | 5 | B1 |

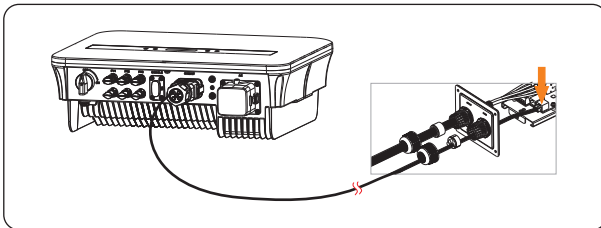

Figure 7-51 Inverter connected with EV-Charger

NOTICE!

- The parallel system with Modbus Function, the parallel system with Datahub and the EV-Charger application can not be realised at the same time, choose only one of these applications at a time.

External connection with Adapter Box G2

- Connection diagram

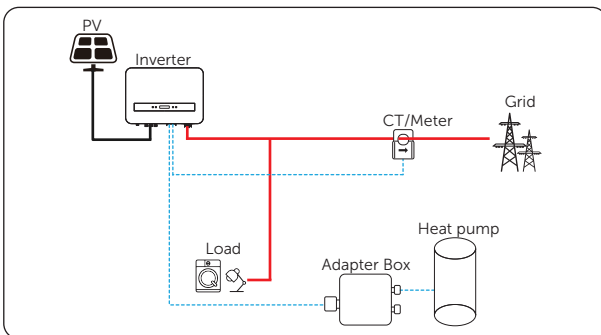

Figure 7-52 Adapter Box G2 connection diagram

- Pin assignment

| Section C of COM/CT port of the inverter | | RS485-INV port of SolaX Adapter Box G2 | |
|--|----------------|--|----------------|
| Pin | Pin definition | Pin | Pin definition |
| 13/15 | RS485A | 4 | RS485-A |
| 14/16 | RS485B | 5 | RS485-B |

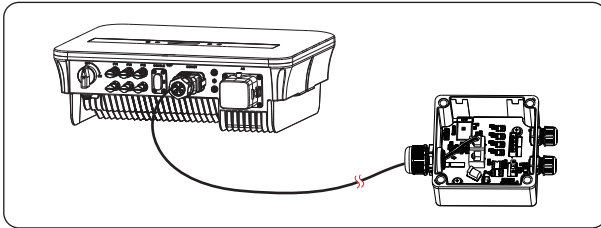

Figure 7-53 Inverter connected with Adapter Box G2

7.5 Monitoring Connection

The inverter provides a DONGLE port, which can transmit data of the inverter to the monitoring website via Wi-Fi dongle (Optional), LAN dongle (Optional) and 4G dongle (Optional), etc. (If necessary, purchase products from us.)

NOTICE!

Wi-Fi dongle

- Harness the power of WiFi with Wi-Fi dongle, connect to a local network within 50 m of the installation to enable access to the monitoring platform.

NOTICE!

LAN dongle

- If Wi-Fi isn't suitable for your situation, the LAN dongle enables you to connect to your network via an ethernet cable. Ethernet allows for a much more stable connection with less interference.

NOTICE!

4G dongle

- 4G dongle allows you to use a 4G connection to monitor your system without the option of connecting to a local network. (This product is not available in the UK.)

Monitoring connection diagram

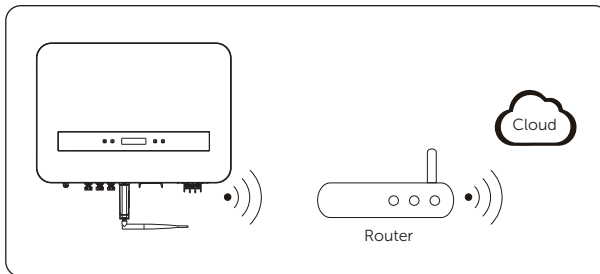

Figure 7-54 Wi-Fi connection diagram

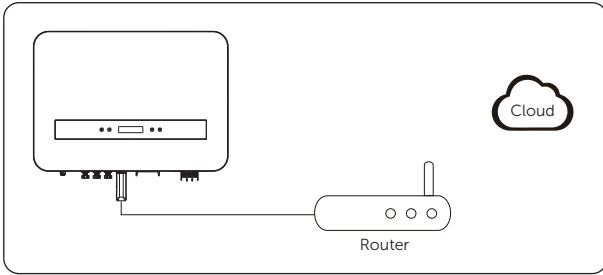

Figure 7-55 LAN connection diagram

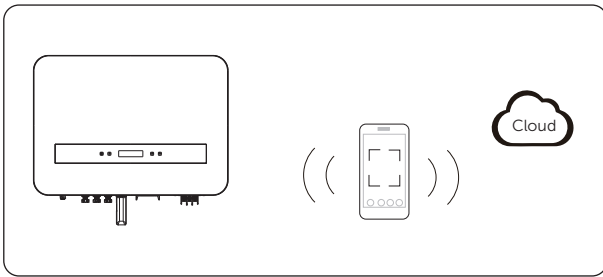

Figure 7-56 4G connection diagram

Wiring procedure

Remove the terminal cap and plug the Wi-Fi/LAN/4G dongle on the inverter.

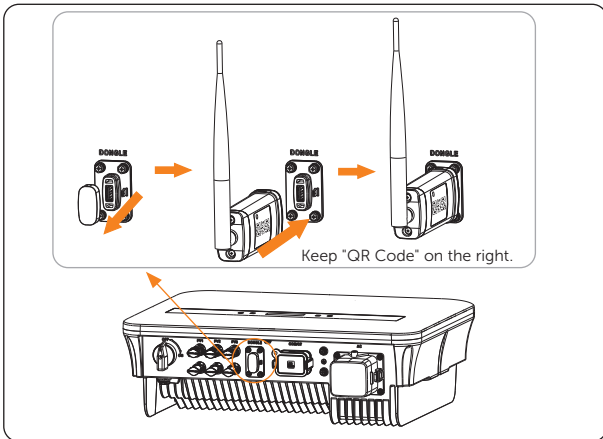

Figure 7-57 Wi-Fi connection procedure

8 System Commissioning

8.1 Checking before Power-on

- a. Check that the device is installed correctly and securely;
- b. Make sure that the device is well-grounded;
- c. Make sure that all the DC breakers and AC breakers are OFF;
- d. Make sure that the AC cable is connected correctly and securely;
- e. Make sure that all DC cables are connected correctly and securely;
- f. All communication cables are connected correctly and securely;
- g. Make sure the meter/CT is connected correctly and securely (If a meter/CT is connected in the system);
- h. Make sure all photovoltaic panels are connected correctly and securely;
- i. Make sure all the connectors which are not used should be sealed by covers;
- j. Make sure the external AC and DC connectors are connected;
- k. Unused terminals and ports are locked by waterproof caps. All the screws are tightened.

8.2 Powering on the System

Step 1: Turn on the DC switch and switch on the AC breaker. (For the operation of lockable DC switch, please refer to "[8.4 Lockable DC switch](#)".)

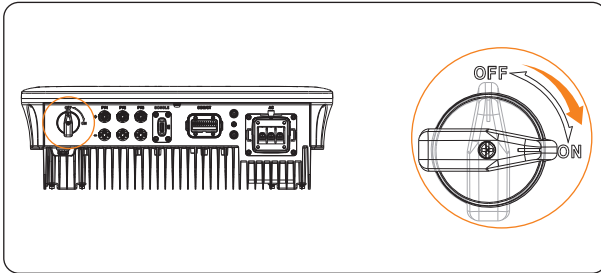

Figure 8-1 Turn on the DC switch

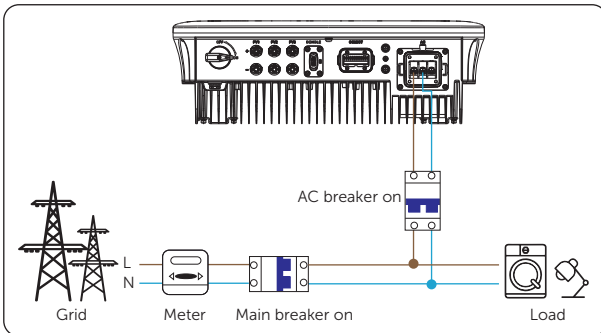

Figure 8-2 Turn on the AC breaker

Step 2: When the photovoltaic panel generates enough power, the inverter will start automatically. The inverter will go Waiting, Checking and Normal status in sequence.

Waiting: The auxiliary power supply of the inverter has been started and the inverter is successfully connected to the mains and waiting for the PV side to meet the working requirement.

Checking: The inverter will automatically detect the DC input. When the photovoltaic panel has enough energy to start the inverter, the inverter will perform self-checks, such as insulation detection, RCD tests.

Normal: The inverter starts to work normally, the operation indicator light is steady in blue. At the same time, the power is fed back to the grid, and the LCD displays the output power.

If error information is displayed on the screen of the inverter, check the possible causes and restart the inverter.

8.3 Checking after Power-on

- Perform **Check CT/Meter** on the LCD panel if **Export Control** is enabled.
- Check the reason if the inverter sticks in Waiting status for a long time (Please refer to "[Waiting Mode](#)").

8.4 Lockable DC switch

There are two kinds of DC switch for the series inverters:

- Unlockable DC switch (without lock; applied to most countries and regions);
- Lockable DC switch (with lock; mainly applied to Australia and New Zealand).

For lockable DC switch, there are two types. Please refer to the actual delivery and the corresponding instructions as follows.

Lockable DC switch (Type 1)

- States of the lockable DC switch (Type 1):

For the lockable DC switch, there are 3 states: ON, OFF and OFF+Lock and the default state is OFF.

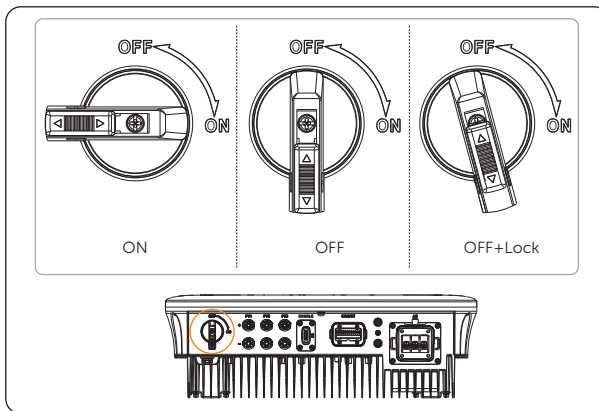

Figure 8-3 States of the lockable DC switch (Type 1)

- Operation of the lockable DC switch (Type 1):

- » Turn on

Rotate from OFF state to ON state.

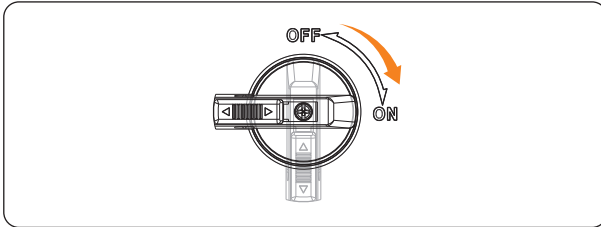

Figure 8-4 Turning on the lockable DC switch (Type 1)

- » Turn off

Rotate from ON state to OFF state.

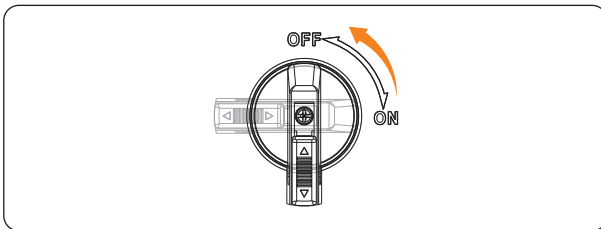

Figure 8-5 Turning off the lockable DC switch (Type 1)

- » Lock

Rotate the DC switch from OFF state to slightly left side and push up the buckle as shown below. Then secure it with a lock (Please prepare a lock in advance)

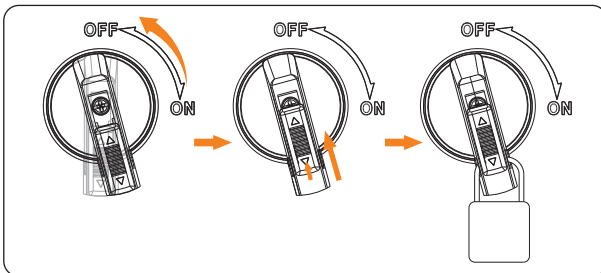

Figure 8-6 Locking the lockable DC switch (Type 1)

» Unlock

Remove the lock, push down the buckle as shown below and wait for it to return to OFF state.

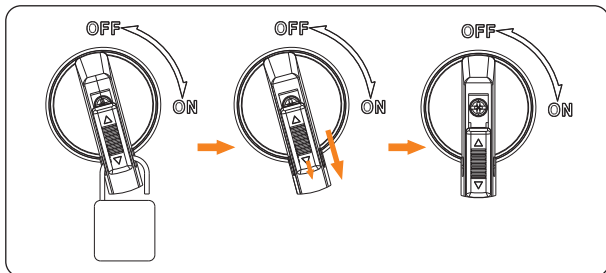

Figure 8-7 Unlocking the lockable DC switch (Type 1)

Lockable DC switch (Type 2)

- States of the lockable DC switch (Type 2):

For the lockable DC switch, there are 3 states: ON, OFF and OFF+Lock and the default state is OFF.

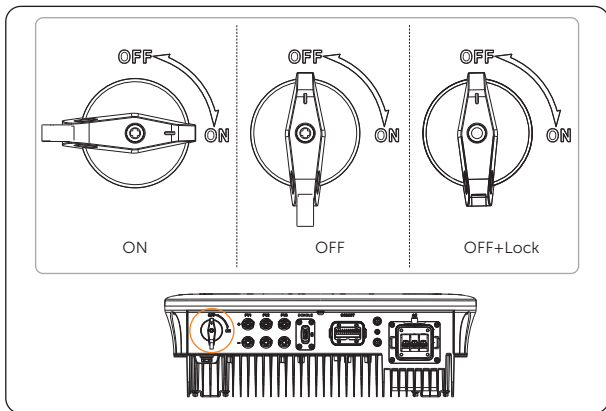

Figure 8-8 States of the lockable DC switch (Type 2)

- Operation of the lockable DC switch (Type 2):

- » Turn on

Rotate from OFF state to ON state.

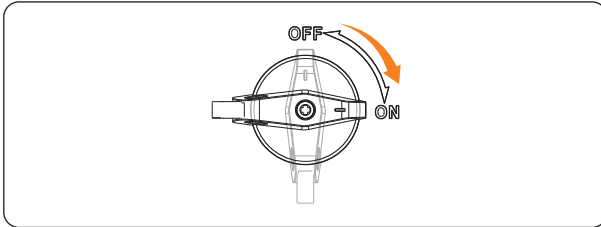

Figure 8-9 Turning on the lockable DC switch (Type 2)

- » Turn off

Rotate from ON state to OFF state.

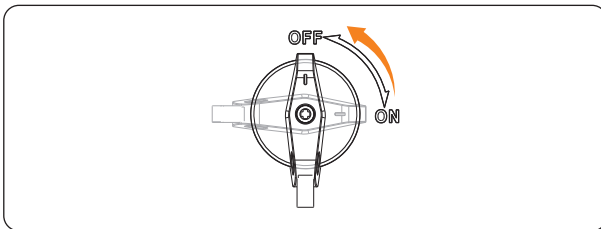

Figure 8-10 Turning off the lockable DC switch (Type 2)

- » Lock

Make sure the DC switch is in OFF state and push up the buckle as shown below. Then secure it with a lock (Please prepare a lock in advance)

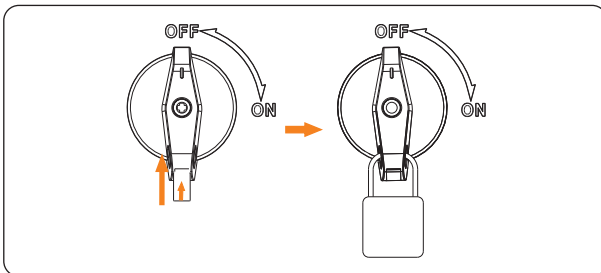

Figure 8-11 Locking the lockable DC switch (Type 2)

» Unlock

Remove the lock and wait for it to return to OFF state.

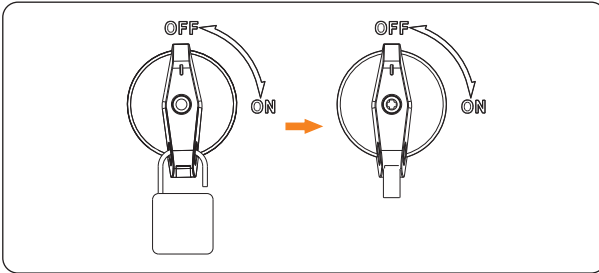

Figure 8-12 Unlocking the lockable DC switch (Type 2)

9 Operation on LCD

9.1 Introduction of Main Interface

The main interface is the default interface, the inverter will automatically jump to this interface when the system starts up successfully or is not operated for a period of time.



The first line shows the following information:

Power means the timely output power;

Pgrid means the power export to or import from the grid (Positive value means the energy feeds into the grid, negative value means the energy used from the grid);

Today means the energy generated within the day;

Total means the energy generated until now.

The second line shows the running status of the inverter. **Normal** means the inverter is in normal status.

When the inverter is in fault status, the error code and information will be displayed.

9.2 Introduction of Menu Interface

When the inverter shows the default interface, long press "Enter" key to enter the menu interface. There are eight submenus in the menu that can be selected for relevant operations.



Status: Display the real-time value of the inverter, including **Grid** and **Solar**.

Language: Set the language displayed on the inverter.

Date&Time: Set the date and time.

Settings: Set the parameters of the inverter.

Meter Energy: Display the import and export energy information of the inverter.

Error Logs: Display the error logs of the inverter.

Waiting Mode: Display the specific reason code why the inverter is in waiting mode.

About: Display the information about the inverter.

Status

Status display the real-time value of the inverter, including **Grid** and **Solar**.



• Grid

Grid shows the current condition of the AC output of the inverter, including **U, I, F, Pout, Pgrid**.

U: The voltage of the AC output of the inverter.

I: The current of the AC output of the inverter.

F: The frequency of the AC output of the inverter.

Pout measures the output power of the inverter.

Pgrid measures power export to or import from the grid.

Positive value means the power feeds into the grid, negative value means the power used from the grid.



• Solar

Solar shows the real time PV condition of the system, such as input voltage, current and power situation of each PV input.



Language

This inverter provides multiple languages for customers to choose, such as English, German, Polish, French, Portuguese, etc. You can set the display language based on actual need.



Date&Time

You can set the current date and time of the installation site.

The display format is "2023-09-15 01:15", in which the first four numbers represent the year (e.g. 2000~2099); the fifth and sixth numbers represent the month (e.g. 01~12); the seventh and the eighth numbers represent the date (e.g. 01~31). The remaining numbers represent the time.



Settings

The user can set the parameters of the inverter here.

- **Password**

Once entered from the menu page after selecting **Settings**, the password must be inputted.



The default password is "2014" for the installer, which only allows the installer to review and modify necessary settings complying to the local rules and regulations. If further advanced setting is required, please contact the distributor or us for assistance.

NOTICE!

Property losses or system damage due to unauthorized access to adjustable parameters.

- All the adjustable parameters including safety code, grid parameter, export control, etc can be modified under the permissions of installer password. Unauthorized use of the installer password by unauthorized persons can lead to incorrect parameters being inputted, resulting in power generation loss or violation of local regulation. Get the installer password from the dealer and never open the password to unauthorized person.
- Replace the password with a new secure password for the consideration of account security.
- Keep the system out of reach of children.

After inputting the password, you can view the submenus of the setting parameters.



The submenus contain the following items. For details, please refer to "[9.3 Detailed Operation of Settings](#)".

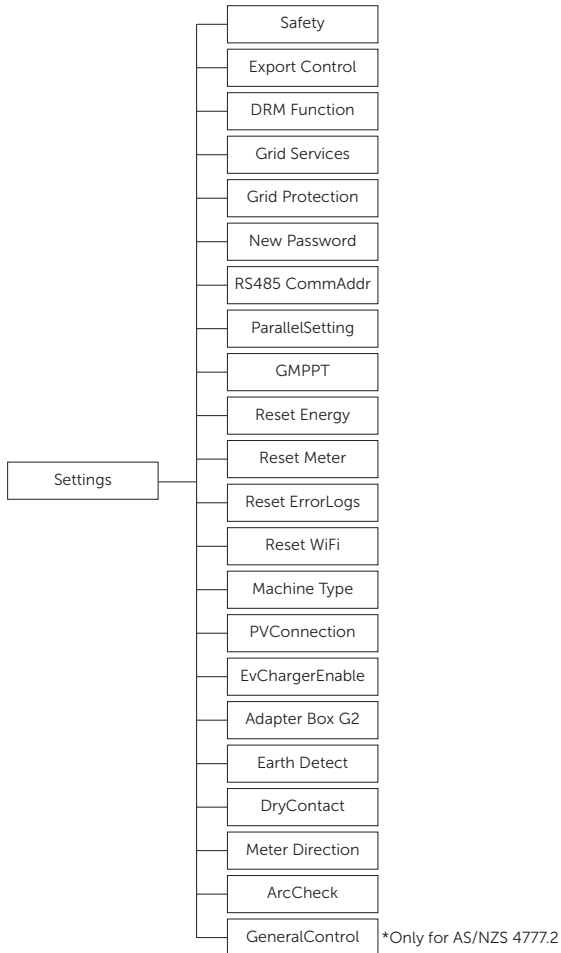

Meter Energy

The user can check the import and export energy by this function. There are two parameters: **Total Import**, **Total Export**. Only when a meter or CT is installed in the system can the inverter accumulate the energy takes from or feeds into the grid. If there is no meter or CT in the system, the value will be 0.



Error Logs

The **Error Logs** contain error information happened. It can record six items at most. Each item includes the date and time the error happened and the error name.



Waiting Mode

Waiting Mode displays the specific reason code why the inverter is in waiting mode. You can check the reason code here, when the inverter is not in waiting mode, it will be displayed as **None**. Please refer to below table for details.

If the inverter sticks in waiting mode for a long time, please contact with our service support and provide the waiting mode information displayed on the screen for assistance.



Table 9-1 Descriptions of Waiting Mode

| Code | Description |
|------|---|
| 001 | Waiting due to insufficient PV power supply or communication failure between DSP and ARM. |
| 002 | Waiting to connect to the grid. |
| 003 | Waiting due to remote shutdown. |
| 004 | Waiting due to shutdown through DRM0 control. |
| 005 | Waiting due to abnormal lease mode. |
| 006 | Waiting when reading configuration files from the U disk. |
| 007 | Waiting due to communication lost when connected in parallel. |

About

This interface shows the information of the inverter, including **Product SN, Register SN, Master, Manager, Internal code.**



9.3 Detailed Operation of Settings

The user can set the safety code, grid, connection etc. of the inverter here.

9.3.1 Safety

In order for the inverter to be able to feed in, the safety code must be set to the installation site correctly. Here you can set safety code according to different countries and grid-tied standards. There are several standards for choice (May change without notice). In addition, the user has a **UserDefined** option which allows the user to customize relevant parameters within a wider range.



NOTICE!

- The inverter cannot be connected to the grid before the safety code is correctly set. If there is any doubt about your safety code where the inverter installed, please consult your dealer or SolaX service for details.

NOTICE!

- For Australia and New Zealand regions, please select Australia Region A/B/C in compliance with AS/NZS 4777.2:2020. Only after the safety code setting is completed, some designated parameters in the inverter system will take effect according to the corresponding safety regulations.

Table 9-2 Region setting

| Region | Australia A | Australia B | Australia C | New Zealand | |
|--------------------|---------------|---------------|---------------|-------------|---------------|
| Standard Code Name | AS4777_2020_A | AS4777_2020_B | AS4777_2020_C | New Zealand | Setting Range |
| OV-G-V | 265 V | 265 V | 265 V | 265 V | 230-300 V |
| OV-GV1-T | 1.5 s | 1.5 s | 1.5 s | 1.5 s | |
| OV-G-V2 | 275 V | 275 V | 275 V | 275 V | 230-300 V |

Operation on LCD

| Region | Australia A | Australia B | Australia C | New Zealand | |
|--------------------|---------------|---------------|---------------|-------------|---------------|
| Standard Code Name | AS4777_2020_A | AS4777_2020_B | AS4777_2020_C | New Zealand | Setting Range |
| OV-GV2-T | 0.1 s | 0.1 s | 0.1 s | 0.1 s | |
| UN-G-V1 | 180 V | 180 V | 180 V | 180 V | 40-230 V |
| UNGV1-T | 10 s | 10 s | 10 s | 10 s | |
| UN-G-V2 | 70 V | 70 V | 70 V | 70 V | 40-230 V |
| UNGV2-T | 1.5 s | 1.5 s | 1.5 s | 1.5 s | |
| OV-G-F1 | 52 Hz | 52 Hz | 55 Hz | 55 Hz | 50-55 Hz |
| OVGF1-T | 0.1 s | 0.1 s | 0.1 s | 0.1 s | |
| OV-G-F2 | 52HZ | 52HZ | 55HZ | 55HZ | 50-55 Hz |
| OVGF2-T | 0.1 s | 0.1 s | 0.1 s | 0.1 s | |
| UN-G-F1 | 47 Hz | 47 Hz | 45 Hz | 45 Hz | 40-50 Hz |
| UNGF1-T | 1.5 s | 1.5 s | 5 s | 1.5 s | |
| UN-G-F2 | 47 Hz | 47 Hz | 45 Hz | 45 Hz | 45-50 Hz |
| UNGF2-T | 1.5 s | 1.5 s | 5 s | 1.5 s | |
| Startup-T | 60 s | 60 s | 60 s | 60 s | 15-1000 s |
| Restore-T | 60 s | 60 s | 60 s | 60 s | 15-600 s |
| Recover-VH | 253 V | 253 V | 253 V | 253 V | |
| Recover-VL | 205 V | 205 V | 205 V | 198 V | |
| Recover-FH | 50.15 Hz | 50.15 Hz | 50.15 Hz | 50.15 Hz | |
| Recover-FL | 47.5 Hz | 47.5 Hz | 47.5 Hz | 47.5 Hz | |
| Start-VH | 253 V | 253 V | 253 V | 253 V | |
| Start-VL | 205 V | 205 V | 205 V | 198 V | |
| Start-FH | 50.15 Hz | 50.15 Hz | 50.15 Hz | 50.15 Hz | |
| Start-FL | 47.5 Hz | 47.5 Hz | 47.5 Hz | 47.5 Hz | |

9.3.2 Export Control

This function allows the inverter to control the power fed into the grid. The setting parameters includes **Mode Select**, **Control Mode** and **Check Meter/CT**.



Mode Select

For **Mode Select**, the user can choose from **Disable**, **Meter**, **CT**. The default setting is **Disable**. When **Disable** is chosen, the function will be shut off.

When the user wants to enable this function, choose **Meter** or **CT** according to the actual application, the meter or CT is used to monitor energy exported to the grid.



When enabled, the **User Value** can be set. The user value must be set within the range of 0 to 60 kW. If the user does not want to supply power to the grid, set **User Value** to 0.



Control Mode

For **Control Mode**, the user can set whether to take power from the grid. **Pgrid Bias** and **Pgrid Power** can be set.



For **Pgrid Bias**, the default setting is **Disable**, select **INV** for **Pgrid Bias** to take power from the mains.



For **Pgrid Power**, set the power biased within the range 40 to 100 W according to actual needs when the function is enabled.



Check Meter/CT

For **Check Meter/CT**, the user can select **Yes** under **CT/Meter** to start the checking process and view the **Result**. Whether the checking object is CT or meter depends on the setting of **Mode Select** under **Export Control**.



When **Yes** is selected and confirmed under **CT/Meter**, the system will start the checking process and display the checking result after checking.

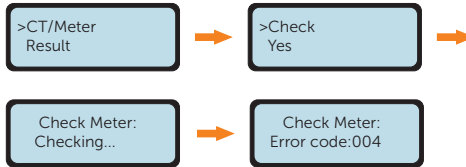

For **Result**, the user can see the result of the latest checking. If the meter or CT is correctly installed, **No Error** will be displayed, otherwise the error code will be displayed. Please refer to below table for details.



Table 9-3 Descriptions of results for Check Meter/CT

| Error code | Description |
|------------|-------------------------------------|
| 001 | The CT is in reverse connection. |
| 002 | The meter is in reverse connection. |
| 003 | The CT is not connected. |
| 004 | The meter is not connected. |

9.3.3 Grid Services

Usually end users do not need to set the grid parameters. All default values have been set before leaving factory according to safety rules.

If reset is needed, any changes should be made according to the requirements of local grid.



There are five submenus under **Grid Services**: **P(freq)**, **Soft Start**, **Reactive Power**, **P(u) Function**, **Power Limits**.

P(freq)

Set the overfrequency and underfrequency parameters of the inverter here.



Table 9-4 Items under P(freq)

| | Items | Description |
|---------------|-----------------------|---|
| P(Over freq) | Enable/Disable | Enable or disable the over-frequency derating function |
| | CurveType (f1/ fstop) | Curve type |
| | fULCO | Upper limit of the continuous operation range for frequency |
| | DroopRate | Rate of active power dropping gradient |
| | EntryDelayTime | Delay time into over-frequency derating |
| | ExitDelayTime | Delay time to exit over-frequency derating |
| | fPmin | Frequency where power output is zero |
| | fhyste | Values for over-frequency hysteresis margin |
| P(Under freq) | Enable/Disable | Enable or disable the under-frequency ramp-up function |
| | fLLCO | Lower limit of continuous operation range for frequency |
| | DroopRate | Rate of active power increasing gradient |
| | EntryDelayTime | Delay time into under-frequency ramp-up |
| | fhyste | Values for under-frequency hysteresis margin |
| | fPmax | Frequency where power output level is maximum |
| | ExitDelayTime | Delay time to exit under-frequency ramp-up |

Soft start

Set the gradient of the power to increase from 0 to full power operation after the inverter enters the normal state if enabled.



Once enabled, the user can set the soft start rate. If set as shown, 9 percent of the rated power increase per minute.

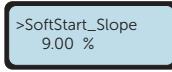

ReconSlope set the gradient of the power to increase from 0 to full power operation when the inverter enters the normal state again after power failure or error report.



Reactive Power

The items in the **Reactive Power** interface will be adjusted in accordance with the local safety requirements and law regulations, casual modification is prohibited.

Off, **Fixed Q Power**, **Q(u)**, **PF(p)**, **Under Excited**, and **Over Excited** can be selected in **Reactive Power** interface. Adjust the parameters under each setting in the table.



Table 9-5 Items under each mode of Reative Power

| Mode Select | Items | Description |
|---------------|--------------|--|
| Off | / | Disable reactive power control |
| Fixed Q Power | Q Power | Set a fixed reactive power value in Var |
| Q(u) | QPowerLockEn | Enable or Disable the curves of Voltage and Reactive Power |
| | QuLockIn | Active Power ratio for entering Qu mode |
| | QuLockOut | Active Power ratio of exiting Qu mode |
| | Qu_GridV1 | Curve of Voltage and Reactive Power; Set four points for the output curve |
| | Qu_GridV2 | |
| | Qu_GridV3 | |
| | Qu_GridV4 | |
| | QuRatio1 | Curve of Voltage and Reactive Power; Set four points for the output curve |
| | QuRatio2 | |
| | QuRatio3 | |
| QuRatio4 | | |

| Mode Select | Items | Description | |
|---------------|--------------|---|---------------------------------------|
| PF(p) | PowerFactor1 | Curves of Power and Power-factor; Set four points for the output curve | |
| | PowerFactor2 | | |
| | PowerFactor3 | | |
| | PowerFactor4 | | |
| | PowerRatio1 | | |
| | PowerRatio2 | | |
| | PowerRatio3 | | |
| | PowerRatio4 | | |
| | EntryVolt | | Voltage value for entering PF(p) mode |
| | ExitVolt | | Voltage value for exiting PF(p) mode |
| Under Excited | PF Value | Adjustment of the reactive power by adjusting the power factor (phase angle lagging- load is inductive) | |
| Over Excited | PF Value | Adjustment of the reactive power by adjusting the power factor (phase angle leading - load is capacitive) | |

For AS/NZS 4777.2, the curve required for the volt-var control mode can be referred to the below curve.

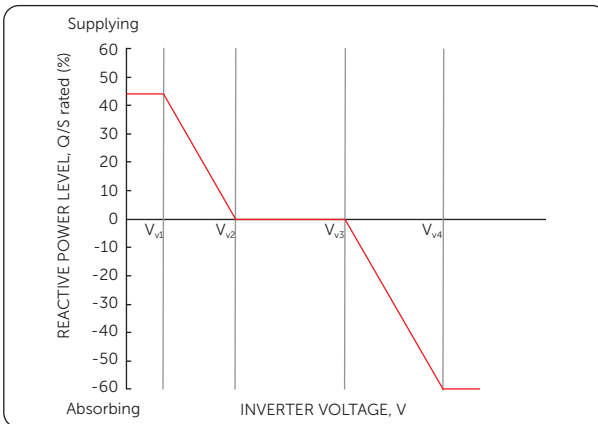

Figure 9-1 Curve for Q(u)

P(u) Function

The **P(u) Function** is a volt-watt response mode required by certain national standards such as AS/NZS 4777.2. This function can control the active power of the inverter according to the grid voltage. **Enable** means that this function is turned on.

The items in the **P(u) Function** interface will be adjusted in accordance with the local safety requirements and law regulations, casual modification is prohibited.



Table 9-6 Items under P(u) Function

| | Items | Description |
|---------------|----------------|--|
| | Enable/Disable | Enable or disable the P(u) Function. |
| P(u) Function | Pu_GridV1 | |
| | Pu_GridV2 | |
| | Pu_GridV3 | |
| | Pu_GridV4 | Curve of Voltage and Active Power; Set four points for the output curve |
| | Pu_Ratio1 | |
| | Pu_Ratio2 | |
| | Pu_Ratio3 | |
| | Pu_Ratio4 | |

For AS/NZS 4777.2, the curve required for the volt-watt mode can be referred to the below curve.

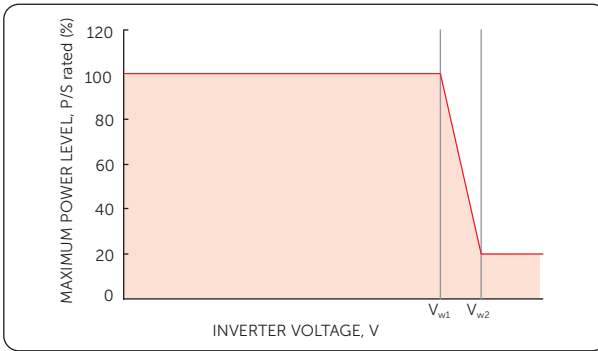

Figure 9-2 Curve for P(u)

Power Limits

Set **Proportion** in the **Power Limits** interface to limit the power of the AC output of the inverter. The setting value is between 0.00 and 1.00.



9.3.4 Grid Protection

Usually end users do not need to set the **Grid Protection**. All default values have been set before leaving factory according to safety rules.

If reset is needed, any changes should be made according to the requirements of local grid.



Table 9-7 Parameters under Grid Protection

| Parameter | Description |
|-----------------|--|
| O/V Stage1 | Slow overvoltage point |
| U/V Stage1 | Slow undervoltage point |
| O/V Stage2 | Rapid overvoltage point |
| U/V Stage2 | Rapid undervoltage point |
| O/V Stage3 | Stage-3 rapid overvoltage point |
| U/V Stage3 | Stage-3 rapid undervoltage point |
| O/V 10min En | 10 min average overvoltage enabled |
| O/V 10min Set | 10 min average overvoltage setting value |
| O/F Stage1 | Slow overfrequency point |
| U/F Stage1 | Slow underfrequency point |
| O/F Stage2 | Rapid overfrequency point |
| U/F Stage2 | Rapid underfrequency point |
| FreqROCOF | Rate of frequency change |
| T_Start | Self-test time |
| H/LVRT Function | High/low voltage ride enabled |
| Frt_EnterVoltUp | Entry value of high voltage ride through |
| Frt_EnterVoltDn | Entry value of low voltage ride through |

| Parameter | Description |
|---------------|--|
| Qu_3Tau | Reactive step response time constant |
| Pu_3Tau | Active step response time constant |
| VacOvp1stTime | Stage-1 overvoltage protection time |
| VacOvp2ndTime | Stage-2 overvoltage protection time |
| VacOvp3rdTime | Stage-3 overvoltage protection time |
| VacUvp1stTime | Stage-1 undervoltage protection time |
| VacUvp2ndTime | Stage-2 undervoltage protection time |
| VacUvp3rdTime | Stage-3 undervoltage protection time |
| FacOfp1stTime | Stage-1 overfrequency protection time |
| FacOfp2ndTime | Stage-2 overfrequency protection time |
| FacUfp1stTime | Stage-1 underfrequency protection time |
| FacUfp2ndTime | Stage-2 underfrequency protection time |
| ReConnectTime | Reconnection time after an error is triggered |
| CosP_Tau3 | Stage-1 response time constant |
| VAC10MAvgT | The voltage value of 10 minutes overvoltage (average) protection |

9.3.5 Functional Settings

DRM Function

The DRM function is a demand response method required by the AS/NZS 4777.2 standard. The default setting is **Disable**. Choose **Enable** to control the inverter's power off through the external communication.



RS485 CommAddr

The user can set the inverter address based on actual needs. The default address is "1" when there is only one inverter in the system, and "2" when there are multiple inverters connected in parallel with Modbus Function in the system. The address of all the inverters connected in parallel with Datahub should be set differently.



ParallelSetting

The inveter provides the parallel connection function. It is disabled by default.



When you want to use the parallel system with Modbus Function, make sure that a meter or CT is connected to the master inverter and **Meter** or **CT** is chosen under **Export Control** accordingly, then enable this function and complete the settings.



When you want to use the parallel system with Datahub, make sure this function is kept disabled.

For **M/S Mode**, select **Master** for the master inverter in the system. Only one inverter in the same system can be selected as a master inverter. Select **Slave** for the slave inverters.



Set the value for **System Limit** on the master inverter. This will be the overall power limit for the parallel system. The output power of the slaves will then be distributed respectively according to their nominal output power. The value can be set within the range of 0 kW and the default value is 0 W.



NOTICE!

- The power limit value set in **System Limit** is the limit for the multiple inverters in the parallel system, while the **User Value** set in **Export Control** is the power limit for a single inverter which will be nullified when the parallel function is enabled.

For details of parallel connection please refer to the instructions in section "[7.4.4 Parallel Connection](#)".

GMPPT

GMPPT is the shadow tracking function. It can adapt to changing weather conditions and maintain power output continuously and effectively through tracking shadows on PV panels. The user can set in this interface in accordance with the real-time situation of each string of PV panels.



There are 4 scanning modes the user can choose to set:

Off means scanning is not required for no shading.

Low means scanning every 4 hours for small amount of shading.

Middle means scanning every 3 hours for medium amount of shading.

High means scanning every 1 hour for large amount of shading.

Please set **Off** to turn off this function when no shadow is on PV panels.



PVConnection

The user can select the PV connection type based on the actual connection ways of PV panels by this function.



EvChargerEnable

If the inverter is to work with the SolaX EV-Charger, **Enable** this function to allow the communication between the inverter and the EV-Charger.



Adapter Box G2

If the inverter is to work with the Adapter Box G2, **Enable** this function to allow the communication between the inverter and the Adapter Box G2.



Earth Detect

The user can enable or disable the **Earth Detect** by this function. **Earth Detect** is disabled by default. When enabled, the inverter will check whether it is grounded, if not a **EarthFault** will be reported.



DryContact

There are two options under this function: **Generator** and **Load Management**.



- **Generator**

The inverter and the generator can form a fuel saver solution. When the user wants to use this solution, choose **ATS** to enable this function. The default setting is **Disable**.



- **Load Management**

The user can use the **DryContact** to connect SG Ready heat pump by this function via Adapter Box (first generation). Select **Load Management** to allow the communication.



There are three functions (**Disable/Manual/SmartSave**) which can be selected for **Load Management**. **Disable** means the heat pump is off. When **Manual** is selected the user can control the external relay to remain close or open manually. **SmartSave** mode can set the values of the heat pump's on/off time, conditions and operating modes.



If the user uses the inverter dry contacts to control heat pump through Adapter box, please refer to the *Adapter Box Quick Installation Guide* to set the parameters here.

Meter Direction

When the inverter is connected with meter/CT, the default setting is **Positive**; while when there is no meter/CT connected the default setting is **Disable**. When the meter/CT is in reverse connection, the user can select **Negative** to enable the meter to work normally.



ArcCheck

The inverter has arc detection function, which detects the arcing of the DC side and cuts the circuit in time to protect the user and the electrical system. The user can do settings about arc detection here, there are five items: **Arc Enable**, **Arc Clear**, **Arc Self Check**, **Arc Version** and **Arc Threshold**.



Select **Enable** in **Arc Enable**, the inverter will report **Arc Fault** when faults are detected. When it is disabled, there won't be any reports even when faults occurred.



When **Yes** in **Arc Clear** is selected, the inverter will clear the arc fault immediately and restart the system. This kind of manual clear can be valid for three times a day. When it is disabled by default, the inverter will automatically clear the arc fault in five minutes and five times at most in a day.



Select **Enable** in **Arc Self Check**, the inverter will self-check whether the arc detection function is working normally and return to **Disable** after the checking process is completed.



NOTICE!

- **Arc Self Check** should be done when the inverter is in normal state and the current is greater than 1.5 A. If an **Arc Fault** is reported and displayed on the inverter if turned back to the main interface, the arc detection function is working normally.

The user can view the version of the arc module in **Arc Version**.



Arc Threshold can set the sensitivity of the arc fault report for arc detection. The range is 0 to 4. "0" (the default value) is the most sensitive, while "4" is the most insensitive. This item cannot be set by the end user. If needed, please contact with us.



9.3.6 Other Settings

New Password

The user can reset the password here.



Reset Energy

The user can clear the feed-in or export power energy data (i.e. **Total Import** and **Total Export** under **Meter Energy**) collected by the inverter by this function (if the user uses CT or meter) when select **Yes**.



Reset Meter

The user can clear the energy data collected by the meter by this function when select **Yes**.



Reset ErrorLogs

The user can clear the errorlogs by this function when select **Yes**.



Reset WiFi

The user can restart the WiFi by this function when select **Yes**.



Machine Type

You can check the machine type by this function.



GeneralControl (Only for AS/NZS 4777.2)

General Control will be shown only under the Australian safety regulations. The user can select from **Soft Limit** and **Hard Limit**, and decide whether to enable this function and set the user value if enabled.

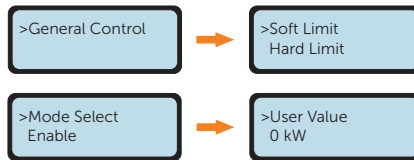

NOTICE!

- **Soft Limit:** The system will control the output value, but won't report any error information even when the actual output value exceeds the set value.
- **Hard Limit:** If the actual output value reaches the set user value for **Hard Limit**, the system will automatically disconnect from the grid and prompt error message on the screen.

10 Operation on SolaX App and Web

10.1 Introduction of SolaXCloud

SolaxCloud is an intelligent management platform for home energy, which integrates energy efficiency monitoring, device management, data security communication and other integrated capabilities. While managing your home energy device, it helps you optimize the efficiency of electricity consumption, improve the revenue of power generation, and meet the unknown energy challenges.

10.2 Operation Guide on SolaXCloud App

10.2.1 Downloading and installing App

Method 1: Select and scan the QR code below to download the app.

The QR codes are also available on the upper-left corner of the login page of our official website (www.solaxcloud.com), and the user manual of the dongle.



App Store

Google play

Figure 10-1 QR code

Method 2: Search for **SolaXCloud** in Apple Store APP or Google Play Store, and then download the app.

10.2.2 Operation on the App

For instructions on related operations, see the online App guide, Wifi connection guide and Setup tutorial video on the SolaXCloud App.

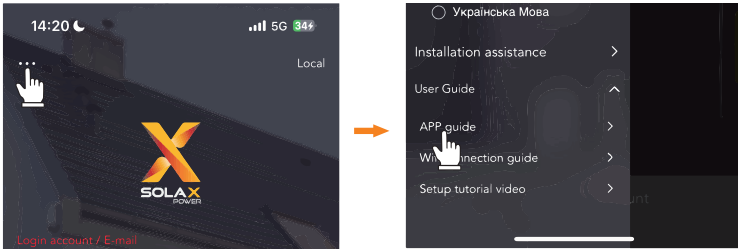

Figure 10-2 App guide on SolaXCloud

NOTICE!

- The screenshots in this chapter correspond to the SolaX Cloud App V4.2.8.

10.3 Operations on SolaXCloud Webpage

Open a browser and enter www.solaxcloud.com to complete registration, login, add site and other related operations according to the guidelines of user guide.

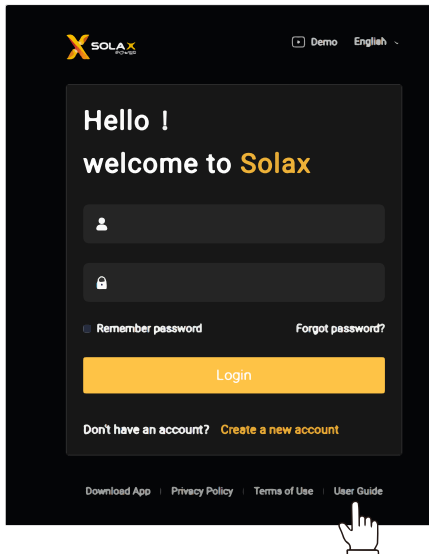

Figure 10-3 User guide on Web

11 Troubleshooting and Maintenance

11.1 Power off

- a. Turn off the AC breaker between the inverter and the power grid;
- b. Set the DC switch to "OFF".

WARNING!

- After the inverter powers off, there will still be the remaining electricity and heat which may cause electric shocks and body burns. Please wear personal protective equipment (PPE) and begin servicing the inverter five minutes after power off.

11.2 Troubleshooting

This section contains information and procedures for resolving possible problems with the inverter, and provides the troubleshooting tips to identify and solve most problems that may occur. Please check the warning or fault information on the system control panel or on the App and read the suggested solutions below when error occurs. Contact SolaX Customer Service for further assistance. Please be prepared to describe the details of your system installation and provide the model and serial number of the inverter.

Table 11-1 Troubleshooting list

| Error Code | Fault | Diagnosis and Solutions |
|--|---------------|--|
| IE: 0101 IE: 0102 IE: 0103 | TzFault | Over Current Fault. <ul style="list-style-type: none">• Wait for about 10 seconds to check if the inverter is back to normal.• Disconnect the DC switch and restart the inverter.• Or seek help from us. |
| IE: 0201 | GridLostFault | Grid Lost Fault. <ul style="list-style-type: none">• Check if the mains cable is loose.• Wait for a while and the system will reconnect when the utility is back to normal.• Or seek help from us. |
| IE: 0301 IE: 0304 IE: 0307 IE: 0310 IE: 0312 | GridVoltFault | Grid Voltage Out of Range. <ul style="list-style-type: none">• Check if the mains cable is loose.• Wait for a while and the system will reconnect when the utility is back to normal.• Or seek help from us. |

| Error Code | Fault | Diagnosis and Solutions |
|--|------------------|--|
| IE: 0401 IE: 0404 IE: 0407 | GridFreqFault | Grid Frequency Out of Range. <ul style="list-style-type: none"> • Wait for a while and the system will reconnect when the utility is back to normal. • Or seek help from us. |
| IE: 0501 IE: 0502 IE: 0503 | PvVoltFault | PV Voltage Fault. <ul style="list-style-type: none"> • Check whether the PV is overvoltage. • Or seek help from us. |
| IE: 0601 IE: 0604 IE: 0607 | BusVoltFault | DC Bus Voltage Out of Normal Range. <ul style="list-style-type: none"> • Check if the PV input voltage is within the operating range of the inverter. • Disconnect PV wiring and reconnect. • Or seek help from us. |
| IE: 0801 | GridVolt10MFault | Grid Overvoltage for Ten Minutes Fault. <ul style="list-style-type: none"> • The system will reconnect when the utility is back to normal. • Or seek help from us. |
| IE: 0901 IE: 0904 | DcInjOCP | DCI Overcurrent Protection Fault. <ul style="list-style-type: none"> • Wait for a while to check if the inverter is back to normal. • Or seek help from us. |
| IE: 1001 | HardLimitFault | Hard Limit Fault (in Australian standard). <ul style="list-style-type: none"> • Wait for a while to check if the inverter is back to normal. • Or seek help from us. |
| IE: 1101 IE: 1104 | SW OCP Fault | Software Overcurrent Protection Fault. <ul style="list-style-type: none"> • Wait for a while to check if the inverter is back to normal. • Disconnect PV and grid, then reconnect. • Or seek help from us. |
| IE: 1201 IE: 1202 IE: 1203 IE: 1204 | ResidualOCP | Overcurrent Protection Fault. <ul style="list-style-type: none"> • Check the connections of the inverter. • Wait for a while to check if the inverter is back to normal. • Or seek help from us. |
| IE: 1301 | IsoFault | Isolation Fault. <ul style="list-style-type: none"> • Check the connections of the inverter. • Or seek help from us. |
| IE: 1401 IE: 1402 IE: 1403 | OverTempFault | Over Temperature Fault. <ul style="list-style-type: none"> • Check if the inverter and the ambient temperature exceeds the operating range. • Or seek help from us. |

| Error Code | Fault | Diagnosis and Solutions |
|----------------------------------|------------------|--|
| IE: 1601 | EarthFault | <p>Earth Fault.</p> <ul style="list-style-type: none"> • Check if the inverter is properly grounded. • Or seek help from us. |
| IE: 2201 IE: 2202 | Arc Fault | <p>Arc Fault</p> <ul style="list-style-type: none"> • Wait for 5 minutes. • Or ask for help from the installer if it can not return to normal. |
| IE: 2401 | Fan Fault | <p>Internal Fan Fault</p> <ul style="list-style-type: none"> • Check if the fan is working. • Or seek help from us. |
| IE: 2501 | InternalComFault | <p>Internal Communication Fault.</p> <ul style="list-style-type: none"> • Restart the inverter to check if it is back to normal. • Update the ARM software or reburn the program. • Or seek help from us. |
| IE: 2801 IE: 2802 | EepromFault | <p>DSP EEPROM Fault.</p> <ul style="list-style-type: none"> • Disconnect PV wiring and reconnect. • Or seek help from us. |
| IE: 2901 | RcDeviceFault | <p>Residual Current Device Fault.</p> <ul style="list-style-type: none"> • Restart the inverter. • Update the ARM software or reburn the program. • Or seek help from us. |
| IE: 3001 IE: 3002 IE: 3003 | PvConnDirFault | <p>PV Direction Fault.</p> <ul style="list-style-type: none"> • Check if the PV+/- sides are connected correctly. • Or seek help from us. |
| IE: 3101 IE: 3102 | GridRelayFault | <p>Relay Fault.</p> <ul style="list-style-type: none"> • Check the grid connection. • Restart the inverter. • Or seek help from us. |
| ME: 0091 | Mgr EEPROM Fault | <p>ARM EEPROM Fault.</p> <ul style="list-style-type: none"> • Disconnect PV and grid, then reconnect. • Or seek help from us. |
| ME: 0092 | Meter Fault | <p>Meter Fault.</p> <ul style="list-style-type: none"> • Check the connection of the meter. • Check if the meter is in working order. • Or seek help from us. |
| ME: 0093 | PowerTypeFault | <p>Power Type Fault.</p> <ul style="list-style-type: none"> • Check the version of ARM and DSP. • Check the product SN number. • Or seek help from us. |

| Error Code | Fault | Diagnosis and Solutions |
|------------|---|--|
| ME: 0094 | Mgr Comm Fault | <p>Manager Inter Communication Fault.</p> <ul style="list-style-type: none"> Restart the inverter to check if it is back to normal. Or seek help from us. |
| ME: 0095 | ComTimeOut20305 | <p>2030.5 Protocol Communication Fault.</p> <ul style="list-style-type: none"> Check the connection of the WiFi module. Or seek help from us. |
| / | Screen not on | <ul style="list-style-type: none"> Check if the inverter correctly and normally connected to PV or grid. Or seek help from us if the inverter is connected correctly. |
| / | Abnormal sound on fan | <ul style="list-style-type: none"> Seek help from us. |
| / | Screen on but no content display | <ul style="list-style-type: none"> Seek help from us. |
| / | LCD screen display stuck in Waiting state | <p>Check if the input voltage of PV is greater than 50 V.</p> <ul style="list-style-type: none"> If it meets the requirement, seek help from us. If the input voltage of PV is less than 50 V, check the PV connection. |
| / | No readings after CT connection | <ul style="list-style-type: none"> Check if CT is correctly clipped on the L wire. Check if the arrow on the CT points at the grid. Or seek help from us if it cannot return to normal. |
| / | No readings on Load (on App or Web) | <ul style="list-style-type: none"> Check if the load is connected correctly. Check if the power of load on the LCD screen displays normally. Check if the monitoring module works normally. Or seek help from us if it cannot return to normal. |
| / | No readings on Grid (on App or Web) | <ul style="list-style-type: none"> Check if the grid connection is normal. Check if the grid parameter on the LCD screen displays normally. Check if the monitoring module works normally. Or seek help from us if it cannot return to normal. |
| / | No Feedin data (on App or Web) | <ul style="list-style-type: none"> Check if the meter/CT is connected correctly. Check if the meter/CT parameter on the LCD screen displays normally. Check if the monitoring module works normally. Or seek help from us if it cannot return to normal. |
| / | No data on App or Web | <ul style="list-style-type: none"> Check if the monitoring module works normally. Or seek help from us. |

11.3 Maintenance

Regular maintenance is required for the inverter. The table of "Proposal of Maintenance" below lists the operational maintenance for expressing the optimum device performance. More frequent maintenance service is needed in the worse work environment. Please make records of the maintenance.



- Only qualified person can perform the maintenance for the inverter.
- Only use the spare parts and accessories approved by SolaX for maintenance.

11.3.1 Maintenance Routines

Table 11-2 Proposal of Maintenance

| Item | Check Notes | Maintenance Interval |
|-------------------------|--|----------------------|
| Safety check | <ul style="list-style-type: none"> • Check the items mentioned in section 1 "Safety". • The safety check shall be performed by manufacturer's qualified person who has adequate training, knowledge, and practical experience. | Every 12 months |
| Indicators | <ul style="list-style-type: none"> • Check if the indicators of the inverter are in normal state. • Check if the display of the inverter (if it has screen) is normal. | Every 6 months |
| Input and output cables | <ul style="list-style-type: none"> • Cables are securely connected. • Cables are intact, and in particular, the parts touching the metallic surface are not scratched. Check whether the sealing caps of idle DC input terminals fall off. • Check that the idle ports are locked by waterproof caps. | Every 6 months |
| Grounding reliability | Check whether the grounding terminal and ground cable are securely connected and all terminals and ports are properly sealed. | Every 6 months |
| Heat sink | Check whether the heat sink is covered with dirt, clean the machine and absorb dust if necessary. | From time to time |

11.3.2 Upgrading Firmware

Upgrade precautions

 **WARNING!**

- Please make sure that the category format is correct, do not modify the firmware file name. Otherwise, the inverter may not work!

 **WARNING!**

- For the inverter, ensure that the PV input voltage is greater than 65 V (upgrade on sunny days). Otherwise, it may cause serious failure during the upgrade process!

Upgrade preparation

- Please check the inverter version and prepare a U disk (USB 2.0/3.0) and personal computer before upgrading. Please make sure that the size of the U disk is smaller than 32G, and the format is FAT 16 or FAT 32.
- Please contact our service support to obtain the firmware, and store the firmware in the U disk according to the following path:
 - » For ARM file: update\ARM\323101XXXXXX_XX_XXXXX_XX_ARM_Vxxx.xx_20xxxxxx.bin
 - » For DSP file: update\DSP\323101XXXXXX_XX_XXXXX_XX_DSP_Vxxx.xx_20xxxxxx.bin
 - » For package file: update\WHOLE\323101XXXXXX_XX_XXXXX_XX_ALL_Axxx.xx_Dxxx.xx_20xxxxxx.bin

NOTICE!

- xxx.xx refers to the file version, 20xxxxxx refers to date.

Upgrade steps

- Step 1:** Please save the corresponding upgrade firmware in your U disk first. If ARM and DSP is to be upgraded separately, save the ARM file and DSP file; if they are to be upgraded in package, save the package file.
- Step 2:** Find the **DONGLE** port of the inverter, unplug the monitoring module (Wifi Dongle/ LAN Dongle/ 4G Dongle etc.) by hand, and insert the USB flash drive. (Refer to section "[7.5 Monitoring Connection](#)" for the specific position of **DONGLE** port.)

Step 3: Complete the upgrade setting following the instructions below.

- Upgrade ARM and DSP separately (Using ARM file and DSP file)
 - a. Select **ARM** and **OK** to enter the software version interface.



- b. Please confirm the new firmware version again and select the firmware to upgrade. The upgrade takes about 20 seconds. When it is completed, the LCD screen returns to the Update page.



- c. For DSP, please wait for 10 seconds. When the Update page shown as below, press down to select **DSP** and **OK** enter the software version interface.



- d. Please confirm the firmware version again and select the firmware to upgrade. The upgrade takes about 2 minutes.

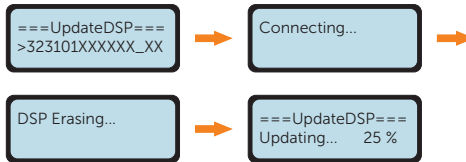

- Upgrade in package (Using package file)

The system will automatically start the upgrading process when read the package file, just wait for the system to complete the process. The whole upgrade takes about two and a half minutes.

Step 4: After the upgrade is completed, the LCD screen will return back to the main interface.

 **CAUTION!**

- If the ARM firmware upgrade fails or stops, please do not unplug the U disk, power off the inverter and restart it. Then repeat the upgrade steps.

 **CAUTION!**

- If the DSP firmware upgrade fails or stops, please check whether the power is off. If it is normal, plug in the U disk again and repeat the upgrading process. If the power is off, try restoring power and then repeat the upgrading process.

NOTICE!

- If the display screen is stuck after the upgrade, please turn off the photovoltaic power supply and restart, and the inverter will restart and return to normal. If not, please contact us for help.

12 Decommissioning

12.1 Disassembling the Inverter



- When disassembling the inverter, strictly follow the steps as below.
- Only use measuring devices with a DC input voltage range of 1000 V or higher.

Step 1: Turn off the external AC breaker and DC breaker.

Step 2: Turn the DC switch to "OFF" position.

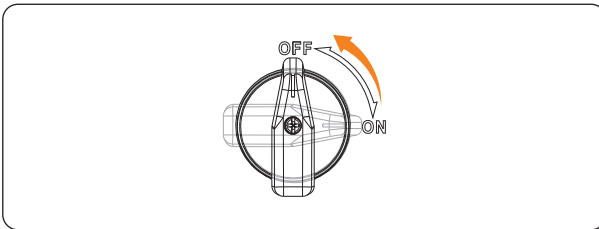

Figure 12-1 Turning off the DC switch

Step 3: Wait for at least 5 minutes to fully discharge the capacitors inside the inverter.

Step 4: Use a current clamp to ensure there is no current present in the DC cables and AC cables.

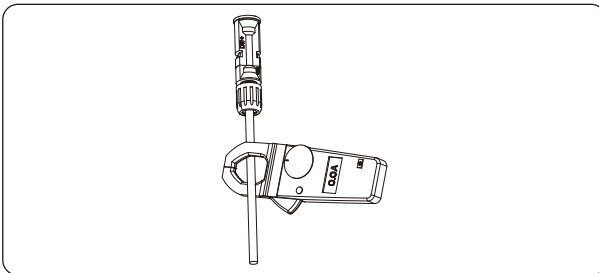

Figure 12-2 Detecting the current

Step 5: Disconnect the PV connectors. Slightly pull out the connectors.

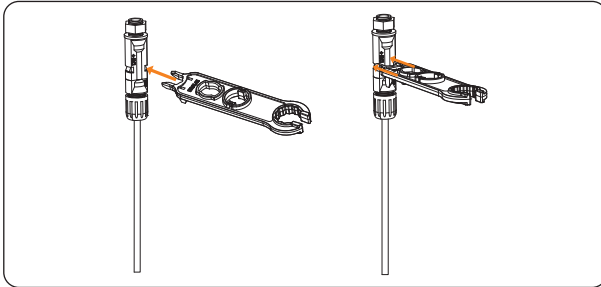

Figure 12-3 Inserting the tool into the PV connector

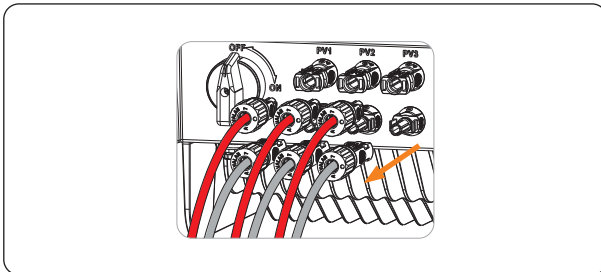

Figure 12-4 Pulling out PV connectors

Step 6: Ensure that no voltage is present between the positive terminal and negative terminal at the DC inputs using a suitable measuring device.

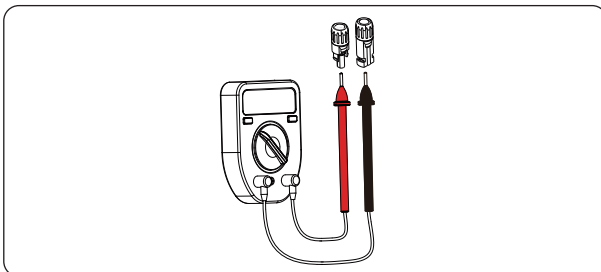

Figure 12-5 Measuring the voltage of PV connectors

Step 7: Disconnect the AC connector and disconnect the AC cable.

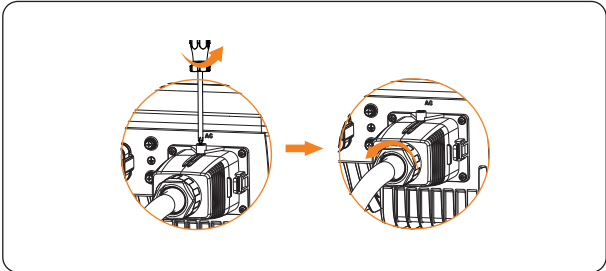

Figure 12-6 Disconnecting the AC connector

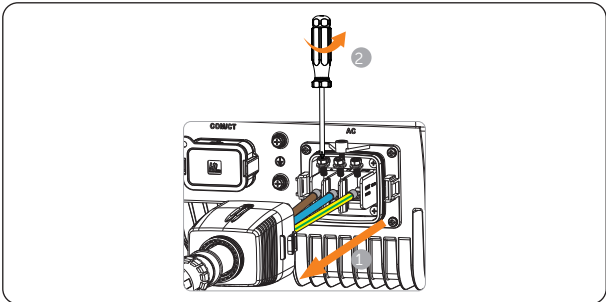

Figure 12-7 Disconnecting the AC cable

Step 8: Disconnect the communication connector from the inverter and disassemble the communication connector to remove the communication cable(s) if needed. If the communication connector needs to be disassembled, please turn the lock in the middle part of the connector to the right side with one hand and maintain the force while rotating the swivel nut anti-clockwise with the other hand at the same time.

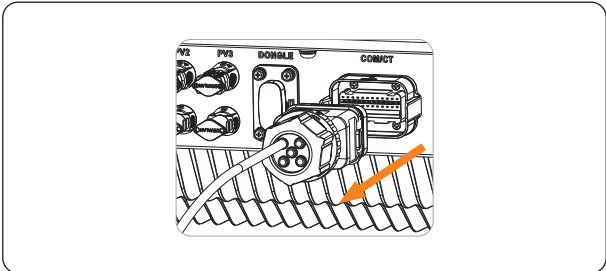

Figure 12-8 Disconnecting the communication connector

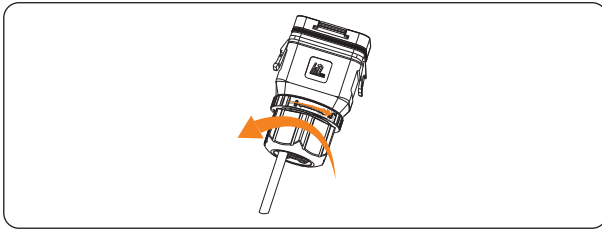

Figure 12-9 Disassembling the communication connector

Step 9: Unplug the dongle from the inverter.

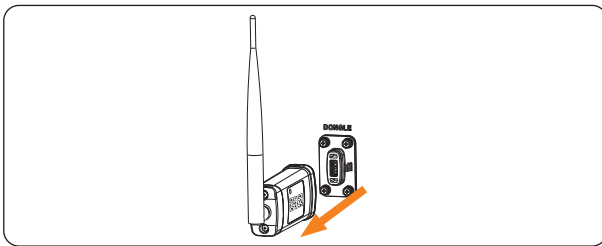

Figure 12-10 Unplugging the dongle

Step 10: Put the original protective caps on the terminals.

Step 11: If an additional grounding is connected to the inverter, unscrew the screw(s) and remove the grounding cable(s).

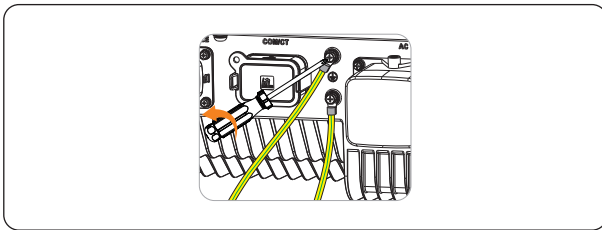

Figure 12-11 Disconnecting the grounding cable(s)

Step 12: Unscrew the M5 screw on the left side of inverter and vertically lift up the inverter to dismantle the inverter.

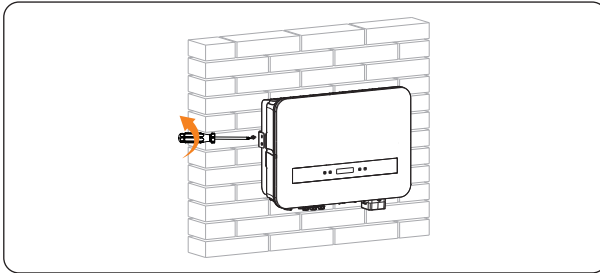

Figure 12-12 Unscrewing the M5 screw

Step 13: Unscrew the screws for fastening the wall mounting bracket and remove the wall mounting bracket if necessary.

12.2 Packing the Inverter

- Load the inverter into the original packing material if possible.
- If the original packing material is not available, you can also use the packing material which meets the following requirements:
 - » Suitable for the weight of product
 - » Easy to carry
 - » Be capable of being closed completely

12.3 Disposing of the Inverter

Please dispose of the inverter or accessories in accordance with the disposal regulations for electronic waste which is applied at the installation site.

13 Technical Data

- DC Input

| Model | X1-SMT-5K-G2 | X1-SMT-6K-G2 | X1-SMT-7K-G2 | X1-SMT-8K-G2 | X1-SMT-9K-G2 | X1-SMT-10K-G2 |
|--|--------------|--------------|--------------|--------------|--------------|---------------|
| Max. PV array input power [Wp] | 10000 | 12000 | 14000 | 16000 | 18000 | 20000 |
| Max. PV voltage [d.c. V] | 600 | | | | | |
| Rated input voltage [d.c. V] | 360 | | | | | |
| MPPT voltage range [d.c. V] | 40-560 | | | | | |
| Max. PV current [d.c. A] | 20/20/20 | | | | | |
| Isc PV array short circuit current [d.c. A] | 25/25/25 | | | | | |
| Startup voltage [d.c. V] | 50 | | | | | |
| No. of MPPT | 3 | | | | | |
| Strings per MPPT | 1 | | | | | |
| Max. inverter backfeed current to the array [d.c. A] | 0 | | | | | |

- AC Output

| Model | X1-SMT-5K-G2 | X1-SMT-6K-G2 | X1-SMT-7K-G2 | X1-SMT-8K-G2 | X1-SMT-9K-G2 | X1-SMT-10K-G2 |
|--|-------------------------|--------------|--------------|--------------|--------------|---------------|
| Rated output apparent power [VA] | 4999 | 6000 | 7000 | 8000 | 9000 | 9999 |
| Max. output apparent power [VA] | 4999 | 6600 | 7700 | 8800 | 9900 | 9999 |
| Nominal AC voltage [a.c. V] | 220/230/240 | | | | | |
| Nominal AC frequency [Hz] | 50/60 (±5) | | | | | |
| Rated output current [a.c. A]* | 21.8 | 26.1 | 30.5 | 34.8 | 39.2 | 43.5 |
| Max. output continuous current [a.c. A] | 22.8 | 30 | 35 | 40 | 45 | 45.5 |
| Current (inrush) [a.c. A] | 13.2 (84 μs) | | | | | |
| THDi, rated power | <3% | | | | | |
| Power factor range | 0.8 leading-0.8 lagging | | | | | |
| Maximum output fault current [a.c. A] | 97 | | | | | |
| Maximum output overcurrent protection [a.c. A] | 80 | | | | | |
| Short circuit current [a.c. A] | 115 | | | | | |

• Efficiency, Safety and Protection



| Model | X1-SMT-5K-G2 | X1-SMT-6K-G2 | X1-SMT-7K-G2 | X1-SMT-8K-G2 | X1-SMT-9K-G2 | X1-SMT-10K-G2 |
|--------------------------------------|--------------|--------------|--------------|--|--------------|---------------|
| Max. efficiency | | | | 98.2% | | |
| Euro efficiency | | | | 97.5% | | |
| Safety & Protection | | | | | | |
| Over/under voltage protection | | | | Yes | | |
| DC isolation protection | | | | Yes | | |
| Monitoring ground fault protection | | | | Yes | | |
| DC injection monitoring | | | | Yes | | |
| Back feed current monitoring | | | | Yes | | |
| Residual current detection | | | | Yes | | |
| Active anti-islanding method | | | | Frequency Shift | | |
| Over temperature protection | | | | Yes | | |
| SPD protection | | | | Type II | | |
| Arc-fault circuit interrupter (AFCI) | | | | Optional | | |
| AC auxiliary power supply (APS) | | | | Optional | | |
| Safety | | | | IEC/EN 62109-1/-2 | | |
| EMC | | | | EN61000-6-1/2/3/4, EN61000-3-2/3/11/12 | | |
| Grid monitoring | | | | AS 4777.2:2020, G99, INMETRO, IEC61727 | | |

• General Data

| Model | X1-SMT-5K-G2 | X1-SMT-6K-G2 | X1-SMT-7K-G2 | X1-SMT-8K-G2 | X1-SMT-9K-G2 | X1-SMT-10K-G2 |
|--|--------------|--------------|--------------|--|--------------|---------------|
| Dimensions (W x H x D) [mm] | | | | 515x370x170 | | |
| Net weight [kg] | | | | 19.5 | | |
| Installation | | | | Wall-mounted | | |
| Operating ambient temperature range [°C] | | | | -25 to +60 | | |
| Storage temperature [°C] | | | | -30 to +70 | | |
| Storage/Operation relative humidity | | | | 0%~100% | | |
| Max. operation altitude [m] | | | | 4000 | | |
| Ingress protection | | | | IP66 | | |
| Isolation type | | | | Transformerless | | |
| Protective class | | | | I | | |
| Night-time consumption | | | | <3 W | | |
| Overvoltage category | | | | III(MAINS), II(DC) | | |
| Pollution degree | | | | II(Inside), III(Outside) | | |
| Cooling concept | | | | Natural cooling | | |
| Typical noise emission [dB] | | | | 30 | | |
| Inverter topology | | | | Non-isolated | | |
| Communication interfaces | | | | WiFi/LAN/4G dongle, RS485, DRM, USB, CT, Meter | | |

Contact Information



UNITED KINGDOM

 Unit C-D Riversdale House, Riversdale
Road, Atherstone, CV9 1FA
 +44 (0) 2476 586 998
 service.uk@solaxpower.com

TURKEY

 KIZILSARAY MAH. 76 SK. LATİF AYKUT
İŞMERKEZİ ALTI NO:16 B- İÇ KAPI NO:
- MURATPAŞA / ANTALYA
 +90 549 841 45 97
 invertersatis@altaytech.com.tr



USA

 3780 Kilroy Airport Way, Suite 200, Long
Beach, CA, US 90806
 +1 (408) 690 9464
 info@solaxpower.com



POLAND

 WARSAW AL. JANA P. II 27. POST
 +48 662 430 292
 service.pl@solaxpower.com



ITALY

 +39 011 19800998
 support@solaxpower.it



PAKISTAN

 +92 341 2687002
 service.pk@solaxpower.com
 owais@solaxpower.com





AUSTRALIA

 21 Nicholas Dr, Dandenong South VIC 3175
 +61 1300 476 529
 service@solaxpower.com



GERMANY

 Am Tullnaupark 8, 90402 Nürnberg,
Germany
 +49 (0) 6142 4091 664
 service.eu@solaxpower.com
 service.dach@solaxpower.com



NETHERLANDS

 Tweekeler-Es 15 7547 ST Enschede
 +31 (0) 8527 37932
 service.eu@solaxpower.com
 service.bnl@solaxpower.com



SPAIN

 +34 9373 79607
 tecnico@solaxpower.com

BRAZIL

 +55 (34) 9667 0319
 info@solaxpower.com

SOUTH AFRICA

 +27 83 565 5865
 service.za@solaxpower.com
 rajen@solaxpower.com



SolaX Power Network Technology (Zhejiang) Co., Ltd.

Add.: No. 288, Shizhu Road, Tonglu Economic Development Zone,
Tonglu City, Zhejiang Province, 310000 P. R. CHINA

Tel.: +86 (0) 571 5626 0011

E-mail: info@solaxpower.com

