

SUNPOWER

FROM MAXEON SOLAR TECHNOLOGIES

NEW REVISION: U

PRELIMINARY

Safety and Installation Instructions

for Europe, Asia, Australia, Latin America and Africa

This document applies to Maxeon Solar PV Modules

Languages:

English
French
German
Italian
Japanese
Spanish

Contents of this manual are subject to change without notice.

In case of inconsistencies or conflicts between the English version and any other versions of this manual (or document), the English version shall prevail and take control in all respects.

For the latest Europe, Asia, Australia, Latin America and Africa please refer to
www.sunpower.maxon.com/int/PVInstallGuideIEC



Maxeon Solar Technologies, Ltd
www.sunpower.maxon.com

Document 001-15497 Rev U
P/N 100657
P/N 520728

English

French

German

Italian

Japanese

Spanish

Safety and Installation Instructions

(English - IEC version)

This document includes references to Maxeon Solar E-series (SPR-Eyy-xxx), X-series (SPR-Xyy-xxx), P-Series (SPR-Pyy-xxx, SPR-P3-xxx, SPR-Py-xxx-UPP), SPR-MAX2-xxx, SPR-MAX3-xxx, SPR-MAX5-xxx PV Modules.

Do not mix E, X, MAX2, MAX3, MAX5, P Series, P3 and P5 in one System.

All module series does not require functional grounding and are compatible with transformer-less inverters (ref. section 4.1)

1.0 Introduction

This manual provides safety and installation instructions for IEC certified Maxeon Solar photovoltaic modules carrying the TUV logo on the product label (Figure 1).



Figure 1

Important! Please read this instruction sheet in its entirety before installing, wiring, or using this product in any way. Failure to comply with these instructions will invalidate the Maxeon Solar Limited Warranty for PV Modules.

1.1 Disclaimer of Liability

The installation techniques, handling and use of this product are beyond company control. Therefore, Maxeon Solar does not assume responsibility for loss, damage or expense resulting from improper installation, handling or use.

1.2 Conformity to International Electrotechnical Commission (IEC) standards

This product meets or exceeds the requirements set forth by IEC 61215 Edition 2-2005 and Edition 3-2016 for PV Modules, as well as IEC 61730 Edition 1 and 2 series for Class II applications. The IEC Standard covers flat-plate PV modules intended for installation on buildings and those intended to be freestanding. This product is not intended for use where artificially concentrated sunlight is applied to the module.

This manual shall be used in combination with industry recognized best practices. Modules should be installed by certified professionals only.

1.3 Limited Warranty

Module limited warranties are described in the Maxeon Solar warranty document obtainable at www.sunpower.maxeon.com. Please read this document for more information.

Warranties do not apply to any of the following;

- PV Modules subjected to: (i) misuse, abuse, neglect or accident;
- (ii) alteration or improper installation (improper installation includes, without limitation, installation or array that does not comply with all Maxeon Solar installation instructions and operations and maintenance instructions of any type (as may be amended and updated from time to time at Maxeon Solar's sole discretion), and all national, state, and local laws, codes, ordinances, and regulations);
- (iii) repair or modification by someone other than an approved service technician of Maxeon Solar;
- (iv) conditions exceeding the voltage, wind, snow load specifications; and any other operational specification;
- (v) power failure surges, lightning, flood, or fire;
- (vi) damage from persons,

- biological activity, or industrial chemical exposure;
- (vii) glass breakage from impact or other events outside Maxeon Solar's control.

2.0 Safety Precautions

Before installing this device, read all safety instructions in this manual.

Danger! Module interconnects pass direct current (DC) and are sources of voltage when the module is under load and when it is exposed to light. **Direct current can arc across gaps and may cause injury or death if improper connection or disconnection is made, or if contact is made with module components that are damaged.** Do not connect or disconnect modules when current from the modules or an external source is present.

- Cover all modules in the PV array with an opaque cloth or material before making or breaking electrical connections.
- Do not disconnect any modules when its inverter is feeding in to the grid. Switch off the inverter before disconnecting, reinstalling or making any action with the modules.
- For connectors, which are accessible to untrained people, it is imperative to use the locking connectors and safety clips, if applicable, in order to defend against untrained personnel disconnecting the modules once they have been installed.
- All installations must be performed in compliance with all applicable regional and local codes.
- There are no user serviceable parts within the module. Do not attempt to repair any part of the module.
- Installation should be performed only by qualified personnel.
- Remove all metallic jewelry prior to installing this product to reduce the chance of accidental exposure to live circuits.
- Use insulated tools to reduce your risk of electric shock.
- Do not stand on, walk, drop, and scratch or allow objects to fall on the glass surface of the modules.
- Damaged modules (broken glass, torn back sheet, broken j-boxes, broken connectors, etc) can be electrical hazards as well as laceration hazards. Contact with damaged module surfaces or module frame can cause electric shock. The dealer or installers should remove the module from array and contact the supplier for disposal instructions.
- Unconnected connectors must always be protected from pollution (e.g dust, humidity, foreign particles, etc), prior to installation. Do not leave unconnected (unprotected) connectors exposed to the environment. A clean assembly environment is therefore essential to avoid performance degradation.
- Do not allow the connectors to come in contact with chemicals such as greases, oils and organic solvents which may cause stress cracking.
- Do not install or handle the modules when they are wet or during periods of high wind.
- Do not block drain holes or allow water to pool in or near module frames
- Maxeon Solar recommend to not mix 160mm cells and 166mm cells modules in a cosmetically sensitive application.
- Contact your module supplier if maintenance is necessary.
- Save these instructions!

3.0 Electrical Characteristics

The module electrical ratings are measured under Standard Test Conditions (STC) of 1 kW/m² irradiance with AM 1.5 spectrum and a cell temperature of 25 °C. Maxeon Solar modules have specific electrical characteristics as shown on the datasheets.

A photovoltaic module may produce more current and/or voltage than reported at STC. Sunny, cool weather and reflection from snow or water can increase current and power output. Therefore, the values of I_{sc} and V_{oc} marked on the module should be multiplied by a factor of 1.25 when determining component voltage ratings, conductor ampacities, fuse sizes, and size of controls connected to PV output. An additional 1.25 multiplier may be required by certain local codes for sizing fuses and conductors. Maxeon Solar recommends the use of open-circuit voltage temperature coefficients listed on the datasheets when determining Maximum System Voltage.

4.0 Electrical Connections

Modules may be connected in series and/or parallel to achieve the desired electrical output as long as certain conditions are met. Please use only the same type of modules in a combined source circuit.

When not controlled by local regulation, Maxeon Solar recommends only mating the same make, model and system rated connectors in a PV system. Maxeon Solar recommends that all wiring be double insulated with a minimum rating of 85° C (185° F). All wiring should use flexible copper (Cu) conductors. The minimum size should be determined by the applicable codes. We recommend a size not less than 4mm². The insulation type should be appropriate for the type of installation method used and must meet SCII (Safety Class II) and IEC 61730 requirements. To minimize the risk from indirect lightning strikes (Voltage surges), the system should be designed to avoid loops in the wiring.

Maxeon Solar recommends a conservative minimum cable bend radius of equal to or greater than 40mm and must not be bent on the direct exit of the connector or junction box. Avoid exposure of electrical connections to direct sunlight and do not place the connector in a location where water could easily accumulate. Installers must refer to connector manufacturer's instruction for further installation and connection requirements.

4.1 System & Equipment Grounding

Please refer to the applicable regional and local codes on grounding PV arrays and mounting frames for specific requirements (e.g. lightning protection).

Module Types
<p>SPR E, X, P series modules and our Maxeon and Performance Product Line are compatible with Transformer Less (TL) inverters, when used as an ungrounded PV source.</p> <p>No frame grounding requirements (including functional frame grounding), but may be subjected to local regulation.</p> <p>Functional system grounding of a polarity (positive or negative) is optional and may be subject to local requirements</p>
<p>E Series: SPR-Eyy-xxx SPR-Eyy-xxx-BLK SPR-Eyy-xxx-COM</p>
<p>X Series: SPR-Xyy-xxx SPR-Xyy-xxx-BLK SPR-Xyy-xxx-COM</p>
<p>P Series/ Performance Product Line: SPR-Pyy-xxx-COM SPR-Pyy-xxx SPR-Pyy-xxx-BLK SPR-P3-xxx-COM SPR-P3-xxx-COM-1500 SPR-P3-xxx SPR-P3-xxx-BLK SPR-Py-xxx-UPP</p>
<p>Maxeon Product Line: SPR-MAX2-xxx SPR-MAX2-xxx-COM SPR-MAX3-xxx SPR-MAX3-xxx-BLK SPR-MAX3-xxx-COM SPR-MAX5-xxx-COM SPR-MAX5-xxx</p>

Note: If you are installing an older Module Type than above mentioned, please refer to different/previous applicable Safety and Installation Manual.

If you are doing a frame grounding connection, avoid the direct contact between Aluminum and Copper using an intermediate metal like stainless steel or tin.

4.2 Series Connection

The modules may be wired in series to produce the desired voltage output. Do not exceed the maximum system voltage specified in module datasheet.

4.3 Parallel Connection

The modules may be combined in parallel to produce the desired current output. Series string must be fused prior to combining with other strings if the resulting maximum reverse current exceeds the fuse rating as shown in the datasheets. Bypass diodes are factory installed in the modules. Please refer to the applicable regional and local codes for additional fusing requirements and limitations on the maximum number of modules in parallel.

5.0 Module Mounting

The Maxeon Solar **Limited** Warranty for PV Modules is contingent upon modules being mounted in accordance with the requirements described in this section.

5.1 Site Considerations

Maxeon Solar modules should be mounted in locations that meet the following requirements:

Operating Temperature: All Maxeon Solar modules must be mounted in environments that ensure Maxeon Solar modules will operate within the following maximum and minimum operating temperatures:

Maximum Operating Temperature	+85 °C (+185 °F)
Minimum Operating Temperature	-40 °C (-40 °F)

Care should be taken to provide adequate ventilation behind the modules, especially in hot environments.

Shading: Modules should be installed so that permanent shading of cells is avoided and partial shading that may occur during certain times of the day or year is minimized.

Shading may induce in certain cases strong energy production reduction, even in case of small shading and should be avoid as much as possible, specially at mid-day when the production is maximum.

Design Strength: Maxeon Solar modules are designed to meet a positive or negative (upward and downward, e.g. wind) withstanding test pressure load and a negative (or downward, e.g. static load or snow load) withstanding test pressure load, as per IEC 61215, when mounted in the configurations specified in Section 5.2 and Tables 1.2 or 1.3 below.

When mounting modules in snow prone or high wind environments, special care should be taken to mount the modules in a manner that provides sufficient design strength while meeting local code requirements.

Additional authorized Operating Environments:

Modules can be mounted in the following aggressive environment according to the test limits mentioned below

Salt mist corrosion testing: IEC 61701 Severity 6

Ammonia Corrosion Resistance: IEC 62716 Concentration: 6,667ppm

Excluded Operating Environments:

Certain operating environments are not recommended for specific Maxeon Solar modules and are excluded from the Maxeon Solar **Limited** Warranty for these modules.

No Maxeon Solar module should be mounted at a site where it may be subject to direct contact with salt water, or other aggressive environment.

Modules should not be installed near flammable liquids, gases, or locations with hazardous materials; or moving vehicles of any type.

Performance Series Mounting Orientation

Performance Series (P-Series) modules are designed to be installed in landscape orientation. In landscape orientation, P-series modules maintain higher power under row to row shading and edge soiling.

5.2 Mounting Configurations

Mounting system must provide a flat plane for the modules to be mounted on and must not cause any twist or stress to be placed on the Module, even in case of thermal expansion.

Modules may be mounted at any angle from horizontal to vertical. Select the appropriate orientation to maximize sunlight exposure. Maxeon Solar recommends for a good performance of the system (reduction of soiling effect/water pooling) a minimum of 5° tilt angle. The cleaning frequency must be increased for modules installed with a very low angle.

Commercial modules (96 & 128 cells) frames have permanently attached stacking pins located a 20mm zone on the long side frame at 388-408 mm ("D" area in Figure 2) . Mounting system hardware used with commercial modules must account for the presence of these stacking pins (see Table 2).

Specific information on module dimensions and the location of mounting and grounding holes is provided in Figures 2 and Table 2.

In order to prevent water from entering the junction box, which could present a safety hazard, modules should not be mounted such that the front/top glass faces downward (e.g., on a tracking structure that positions the module with the junction box facing skyward during sleep mode).

We also want to remind that the watertightness is not ensured by the modules but by the mounting system and that drainage should be well designed for Modules.

Clearance between the module frames and structure or ground is required to prevent wiring damage and allows air to circulate behind the module. The recommended assembling clearance between modules installed on any mounting system is a minimum of 5 mm distance.

When installed on a roof, the module shall be mounted according to the local and regional building and fire safety regulations. In case the module is installed in a roof integrated PV-System (BIPV), it shall be mounted over a watertight and fire-resistant underlayment rated for such application

Modules mounting systems should only be installed on building that have been formally considered for structural integrity, and confirmed to be capable of handling the additional weighted load of the Modules and mounting systems, by a certified building specialist or engineer.

Mounting system supplier shall manage the galvanic corrosion which can occur between the aluminium frame of the Modules and mounting system or grounding hardware if such devices is comprised of dissimilar metals.

The module is only certified for use when its factory frame is fully intact. Do not remove or alter the module frame. Creating additional mounting holes or removing the stacking pins may damage the module and reduce the strength of the frame, therefore are not allowed. Using mounting Clamps or clips with additional grounding bolts or grounding metal sheets could be in compliance with this Safety and Installation Instructions manual subject to conditions of Section 4.1

Modules may be mounted using the following methods only:

- 1) **Frame Holes:** Secure the module to the structure using the factory mounting holes. Four M6 or M8 stainless steel bolts, with nuts, flat washers on both side, and lock washers are recommended per module. Bolts to be fasten according to racking supplier recommendations. Refer to Table 2 for the module dimensions and mounting hole locations. (Please refer to the arrows on the Table 2, E1&E2&E3&E4).
 - 2) **Pressure Clamps or Clips:** Mount the module with the opposite clips on the longer and/or shorter side of the frame of the module. The clips allowed location should be according to Table 1.1. Installers should ensure the clamps are of sufficient strength to allow for the maximum design pressure of the module. Clips and clamps are not provided by Maxeon Solar. Clamps must apply force collinear with the 'wall' of the module frame and not only to the top flange. Clamps shall not apply excessive force to the frame, warp the top flange, or contact the glass, these practices void the module warranty and risk glass breakage. Figure 1a illustrates locations for top frame clamp force. Avoid clamping within 50mm of module corners to reduce risk of frame corner deflection and glass breakage. When clamping to the module frame, torque should never exceed 15 N.m to reduce chances of frame deformation. A calibrated torque wrench must be used. Mounting systems should be evaluated for compatibility before installing specially when the system is not using Clamps or clips. Please contact Maxeon Solar for the approval of the use of non-standard pressure clamps or clips where torque values are higher than otherwise stated.
-
- 3) **End Mount:** End mounting is the capture mounting of the length of the module's shorter frames with clamps on each shorter sides of the frame. Three different configurations are possible: 1) with two mounting rails under the complete length of each shorter side of the Modules, (See Table 1.2), 2) with two mounting rails parallel to the long side of the Modules (See Table 1.2) and 3) without any mounting rail (See Table 1.2). The end-mounting rails and clips or clamps (identified as A_(1&2&3&4) in Table 1.1) must be of sufficient strength to allow for maximum designed test pressure of the module. Verify this capacity with the mounting system of vendor before installation.
 - 4) **Hybrid Mount:** Combination with clamps or clips located on longer or shorter sides of Modules are also possible, see Table 1.2 for allowed configurations. In any case, four clampings points are needed.
 - 5) **Maxeon Solar specified or Maxeon Solar supplied mounting systems.** Modules mounted with strict adherence to Maxeon Solar documentation, using hardware systems supplied by or specified by Maxeon Solar.

Figure 2 and Table 1.1 below demonstrate the mounting locations and Tables 1.2 and 1.3 give allowed load ratings (designed test value) for Maxeon Solar modules.

Figure 2: Mounting Zone locations for Maxeon Solar modules

For 96 cells, P-Series and 104c:

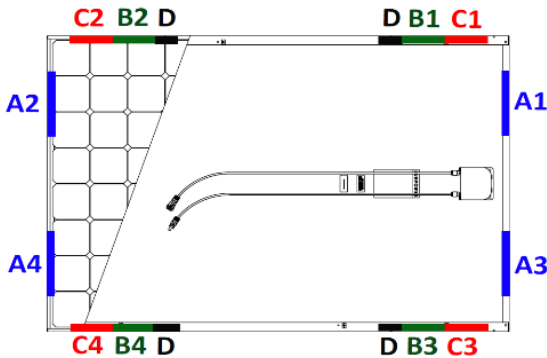

For 128 cells, P-Series and MAX5 Commercial:

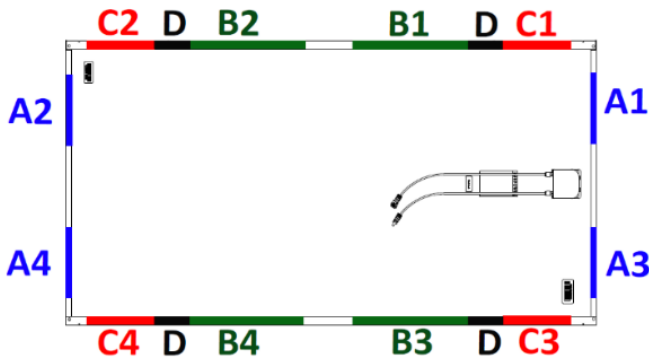

Table 1.1: Approved module clamping/direct fixation zones

Module Configuration		Mounting zone distance from corner in (mm) ¹			Frame holes E (1&2&3&4)
Module size	Frame type	A (1&2&3&4)	B (1&2&3&4)	C (1&2&3&4)	
96 cells, 104 cells (MAX2 and MAX3), P3 BLK and MAX5-RES	G3 (Black) Silver & G4.1 & G4.2 & G4.3 & G5.2	50-350	150-380	50-150	As per Drawing in the Table 2
128 cells and P19-COM	G4 & G4.1 & G4.2	50-350	408-880	50-375	
P3-COM	G4.2 & G4.3	50-350	408-833	50-375	
MAX5-COM	G4.2	50-350	296-796	50-296	

D - There is a 20mm zone at 388-408mm from the corner where mounting is not allowed due to the module stacking pin feature. Not applicable for all P19 Series, all P3 Series, 96 cells residential modules, all 104 cells and MAX5 modules.

1) No part of the module clamp may extend beyond this area.

Figure 3: Mounting Configurations

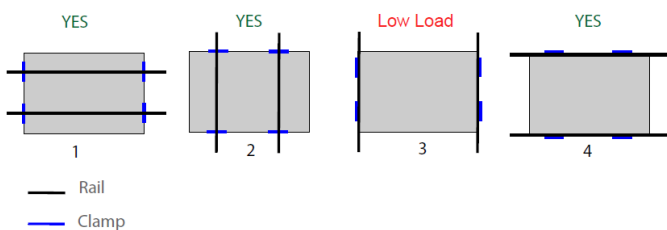

Configurations 1 and 2 show mounting with rail support, 3 and 4 show mounting without rail support. In "With Rail Support" the rails becomes conventional or rails transverse while "Without Rail Support" becomes end mounted in long or short side. In the case when the glass deflects it would not deflect in the rails for additional support.

Table 1.2: Mounting Zone Design Load Ratings for Racking system without rail support underneath the module. Refer to Configuration 3 and 4 in Fig.3

Module Configuration		Wind (up & down) / Snow (down) (units in Pa) (***)			
Module size	Frame type	End Mount A (1&2&3&4)	Frame Holes E (1&2&3&4)	B (1&2&3&4)	C (1&2&3&4) or B + C (B1&3 + C2&4 or B2&4 + C1&3) Or A + B (A1&3 + B2&4 or A2&4 + B1&3) Or A + C (A1&3 + C2&4 or A2&4 + C1&3)
96 cells, 104 cells (MAX2 and MAX3) and P3 BLK	G3 Black & Silver & G4.1 & G4.2 & G4.3	2400/2400 ^(*)	2400/5400	2400/5400	2400/2400
128 cells, P19-COM	G4 & G4.1 & G4.2	Not applicable (**)	2400/5400	3600/3600	2400/2400
P3-COM	G4.2 & G4.3	1600/1600	1600/3600	2000/2400	1600/1600
MAX5-COM	G4.2	Not applicable (**)	2400/5400	3600/3600	1600/1600
MAX5-RES	G5.2	2000/2000	3600/3600	3600/3600	1600/1600

(*) : 5400Pa is allowed with clamps and mounting rails along the longer side of the frame
(**): 2400/2400Pa are allowed with clamps and mounting rails along the longer side of the frame

For Rooftop application 1200/1200Pa is allowed with only clamps

(***) Safety factor of 1.5 included

Table 1.3: Mounting Zone Load Ratings for Racking system with rail support. Refer to Configuration 1 and 2 in Fig.3

Module Configuration		Wind (up & down) / Snow (down) (units in Pa)	
Module size	Frame type	B (1&2&3&4)	C (1&2&3&4)
96 cells, 104 cells (MAX2 and MAX3) and P3 BLK	G3 (Black & Silver) & G4.1 & G4.2 & G4.3	2400 / 5400	2400 / 2400
128 cells and P-series 19-COM	G4 & G4.1 & G4.2	3600 / 5400	2400/ 3600
P3-COM	G4.2 & G4.3	2000/2400	1600/ 1600
MAX5-COM	G4.2	3600/3600	2800/2800
MAX5-RES	G5.2	3600/6000	4000/4000

Figure 4: Mounting Zone Locations for Performance modules

For P3 and P5 UPP:

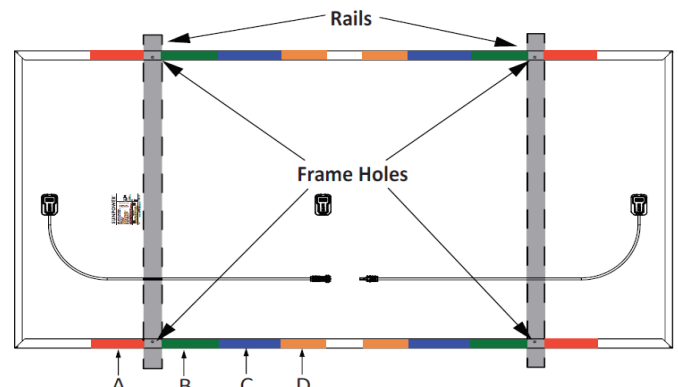

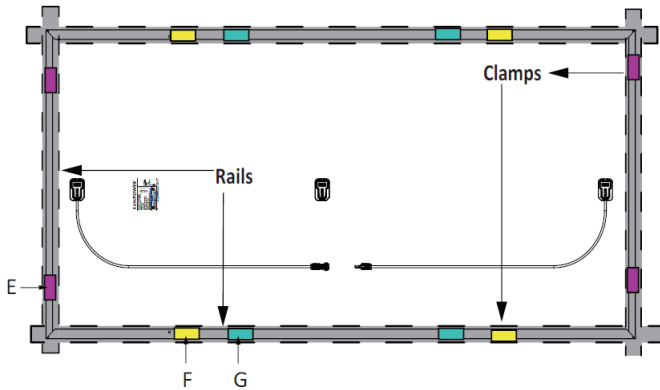

Table 1.4: Mounting Zone Load Ratings for Performance Modules (Pending IEC Certification)

Applicable Products	Mounting Zone	Distance from corner (mm)	Wind (up & down) / Snow(down) (units in Pa) ³	Mounting Method
P3 UPP (2066 x 1160 x 35mm)	A	183-283	1600/2400	Clamp
	B	466-566	1600/3600 ⁴	
	D	783- 833	1600/1600	
	E	300-400	1600/1600	
	F	465-565	1600/2400	
P5 UPP (2384 x 1092 x 35mm)	Frame Holes ²	303	1600/3600	Bolt
		504		
		603		
		803		
P5 UPP (2384 x 1092 x 35mm)	C	540-640	1600/3600	Clamp
	G			

² Refer to Table 2 for different mounting hole locations

³ Safety Factor 1.5 included

⁴ IEC validated

5.3 Bifacial Gain

Various environmental and installation parameters affect bifacial gain. Albedo is a measure of the amount of light reflected from the ground surface. A higher albedo factor will increase irradiance on the backside and result in higher bifacial gain of the module. The surface conditions, month of the year, time of day, GHI and DNI both influence the amount of incident rear side irradiance.

Maxeon Solar recommends to check with solar module mounting hardware supplier in order to determine the Structure Shading factor of your particular installation. The Structure Shading Factor varies with racking system design, irradiance, albedo and height of module installation above ground and has an overall impact on the rear side irradiance mismatch.

The Rearside mismatch losses are proportional to the albedo, height of the modules above ground and structure shading factor. The irradiance non-uniformity on the rear side results in mismatch generally as the albedo increases and installation height of the modules are lower to the ground

5.4 Bifacial Electrical Considerations

The overall electrical bifacial gain is determined by the combination of albedo, irradiance, shading losses from the rear side, rear side mismatch and height of installation above ground. Please refer to the Maxeon datasheet for the electrical outputs with respect to the overall bifacial gain. Please utilise a suitable performance software package to simulate the overall bifacial gain.

5.5 Handling of Modules during Installation

Do not place modules face forward in direct contact with abrasive surfaces like roofs, driveways, wooden pallets, railings, stucco walls, etc...

The module front surface glass is sensitive to oils and abrasive surfaces, which may lead to scratches and irregular soiling.

During storage, modules need to be protected from rain or any kinds of liquids. Required storage temperature is between 10°C to 40°C in a dry environment (humidity between 30 to 80%). Do not store modules outdoor to avoid moisture and wet conditions.

Modules that feature antireflective coated glass are prone to visible finger print marks if touched on the front glass surface. Maxeon Solar recommends handling modules with anti-reflective glass with gloves (no leather gloves) or limiting touching of the front surface. Any finger print marks resulting from installation will naturally disappear over time or can be reduced by following the washing guidelines in Section 6.0 below. Any module coverage (colored plastic tarps or similar) during installation can lead to permanent front glass discoloration and is not recommended. The use of vacuum lifting pads can cause permanent marks on the front glass. Never lift or move the module using the cables or the junction box under any-circumstances.

Shading incidence need to be avoided during PV system operation. The system is not supposed to be energized until the mounting scaffolding, fences or railing have been removed from the roof.

Systems should be disconnected in any cases of maintenance which can cause shading (e.g. chimney sweeping, any roof maintenance, antenna/dish installations, etc).

6.0 Maintenance

Maxeon Solar recommends visual inspection on a regular basis of all modules for safe electrical connections, sound mechanical connection, and freedom from corrosion. This visual inspection should be performed by trained personnel. The standard frequency is once a year according to environmental conditions. Periodic cleaning of modules is recommended but is not required. Periodic cleaning has resulted in improved performance levels, especially in regions with low levels of annual precipitation (less than 46,3cm (18,25 inches)). Consult your dealer or supplier about recommended cleaning schedules for your area.

To clean a module, wash with potable, non-heated, water. Normal water pressure is more than adequate, but pressurized water up to 100 bar (min.50 cm distance) may be used. Maxeon Solar recommends using a large hosepipe and not to perform cleaning at high outside temperatures. Fingerprints, stains, or accumulations of dirt on the front surface may be removed as follows: first rinse off area and let soak for a short period of time (5 mins). Re-wet and use a soft sponge or seamless cloth to wipe glass surface in a circular motion.

Fingerprints typically can be removed with a soft cloth or sponge and water after wetting. Do not use harsh cleaning materials such as scouring powder, steel wool, scrapers, blades, or other sharp instruments to clean the glass surface of the module. Use of such materials or cleaning without consultation will invalidate the product warranty. As dry cleaning is also risky for Anti-Reflective (AR) coated module surface, spinning brush is not recommended for module cleaning.

Table 2: Module Frame Details

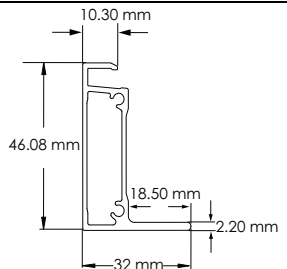
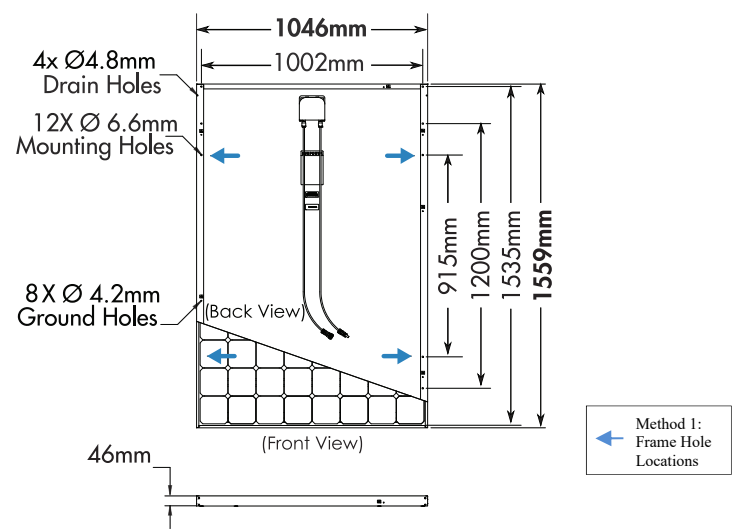
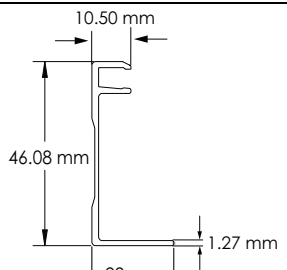
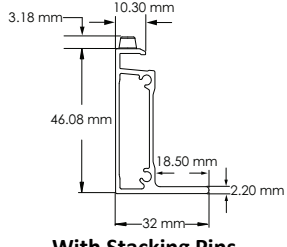
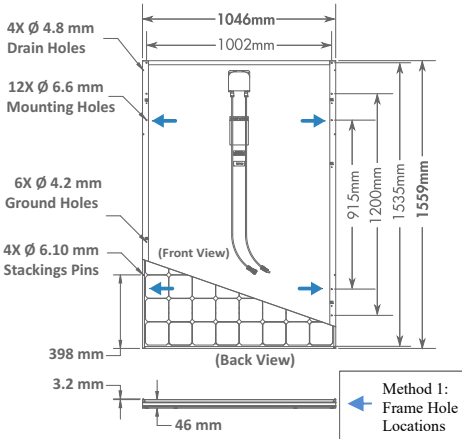
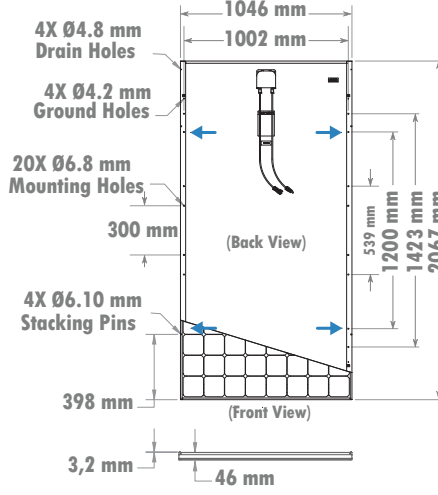
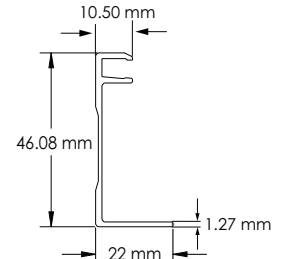
Platform	Module mounting and ground hole detail		Frame Profile
RESIDENTIAL G3 FRAME ONLY			
Residential Modules	96 CELL MODULE FRAME DETAIL		SIDE FRAME PROFILE 
			END FRAME PROFILE 
FOR COMMERCIAL (SILVER FRAME) MODULES ONLY, INCLUDES STACKING PINS			
Commercial Modules	96 CELL COMMERCIAL MODULE	128 CELL COMMERCIAL MODULE	SIDE FRAME PROFILE 
			With Stacking Pins END FRAME PROFILE 

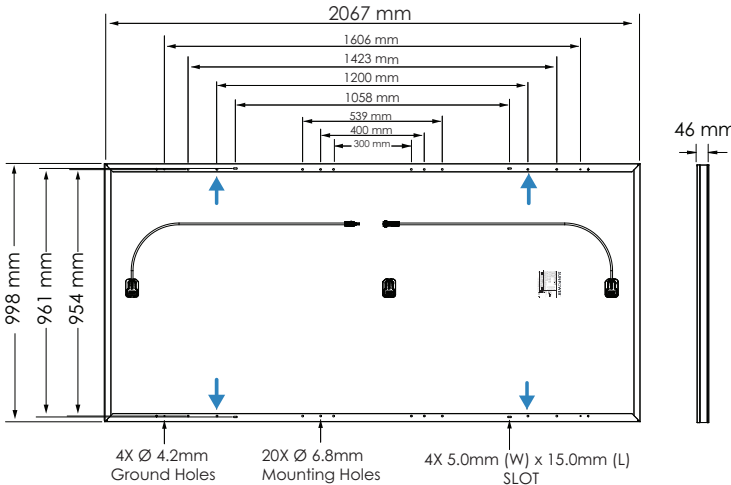
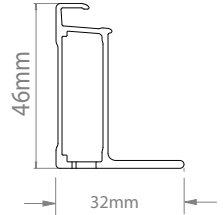
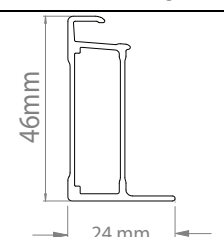
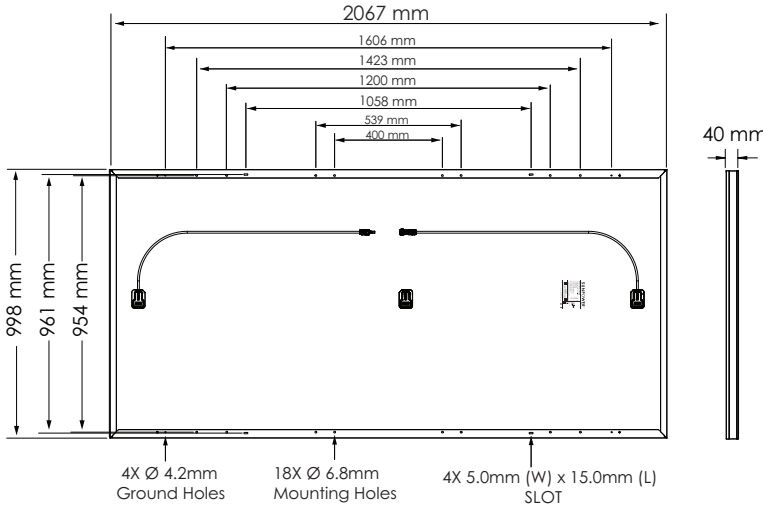
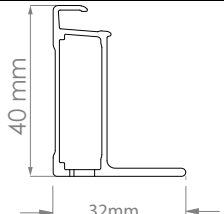
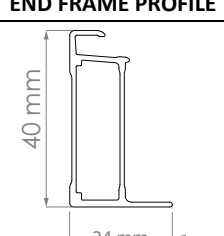
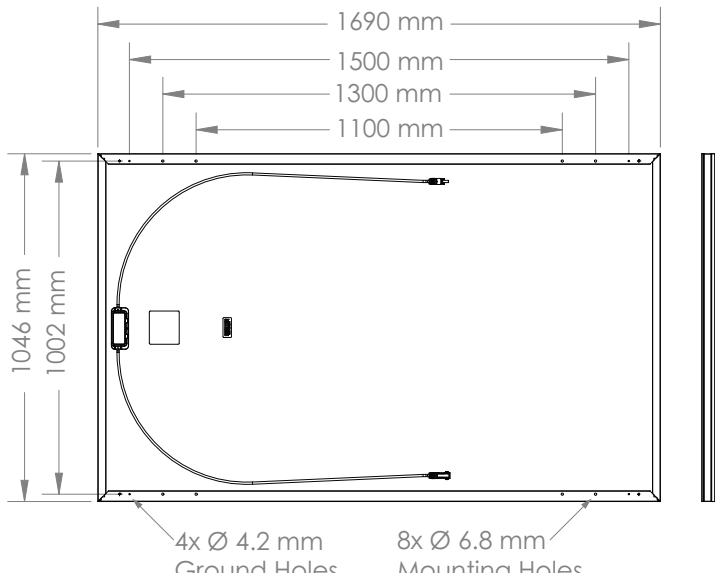
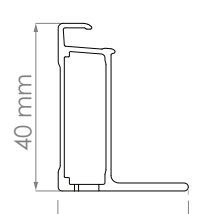
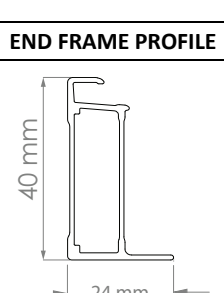
Platform	Module mounting and ground hole detail	Frame Profile
FOR P-SERIES COMMERCIAL GEN 4.1 FRAME MODULES		
Commercial Modules	 <p>Technical drawing of the P-Series Commercial Gen 4.1 frame module. The overall width is 2067 mm and the overall height is 998 mm. The drawing shows the internal layout of the frame with various mounting and ground holes. Dimensions for mounting holes are: 1606 mm, 1423 mm, 1200 mm, 1058 mm, 539 mm, 400 mm, and 300 mm. Dimensions for ground holes are: 961 mm and 954 mm. The frame has 4x Ø 4.2mm Ground Holes, 20x Ø 6.8mm Mounting Holes, and 4x 5.0mm (W) x 15.0mm (L) SLOTS. A side view shows a frame profile with a height of 46 mm and a width of 32 mm.</p>	<p>SIDE FRAME PROFILE</p>  <p>46mm 32mm</p> <p>END FRAME PROFILE</p>  <p>46mm 24mm</p>
FOR P-SERIES COMMERCIAL GEN 4.2 FRAME MODULES		
Commercial Modules	 <p>Technical drawing of the P-Series Commercial Gen 4.2 frame module. The overall width is 2067 mm and the overall height is 998 mm. The drawing shows the internal layout of the frame with various mounting and ground holes. Dimensions for mounting holes are: 1606 mm, 1423 mm, 1200 mm, 1058 mm, 539 mm, and 400 mm. Dimensions for ground holes are: 961 mm and 954 mm. The frame has 4x Ø 4.2mm Ground Holes, 18x Ø 6.8mm Mounting Holes, and 4x 5.0mm (W) x 15.0mm (L) SLOTS. A side view shows a frame profile with a height of 40 mm and a width of 32 mm.</p>	<p>SIDE FRAME PROFILE</p>  <p>40 mm 32mm</p> <p>END FRAME PROFILE</p>  <p>40 mm 24 mm</p>
FOR 104c GEN 4.2 FRAME MODULES		
Commercial Modules	 <p>Technical drawing of the 104c Gen 4.2 frame module. The overall width is 1690 mm and the overall height is 1046 mm. The drawing shows the internal layout of the frame with various mounting and ground holes. Dimensions for mounting holes are: 1500 mm, 1300 mm, and 1100 mm. Dimensions for ground holes are: 1002 mm. The frame has 4x Ø 4.2 mm Ground Holes and 8x Ø 6.8 mm Mounting Holes. A side view shows a frame profile with a height of 40 mm and a width of 32 mm.</p>	<p>SIDE FRAME PROFILE</p>  <p>40 mm 32mm</p> <p>END FRAME PROFILE</p>  <p>40 mm 24 mm</p>

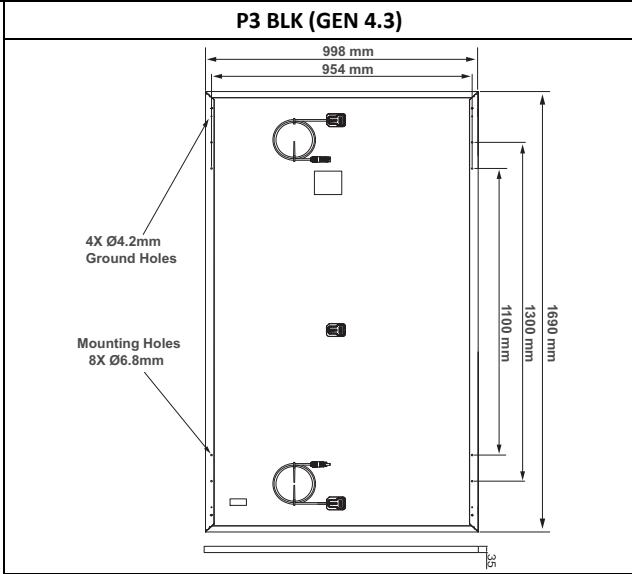
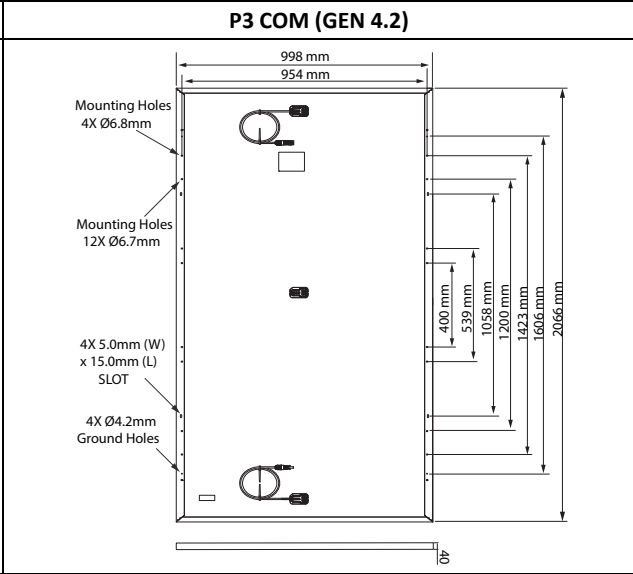
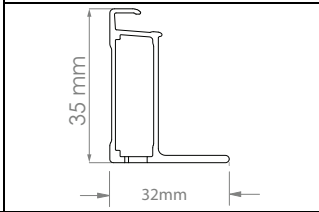
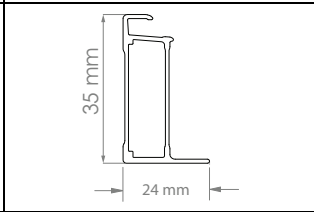
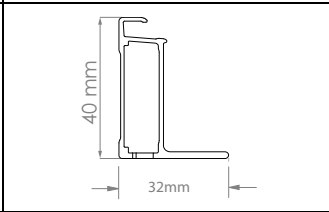
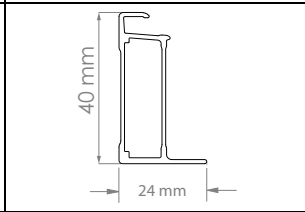
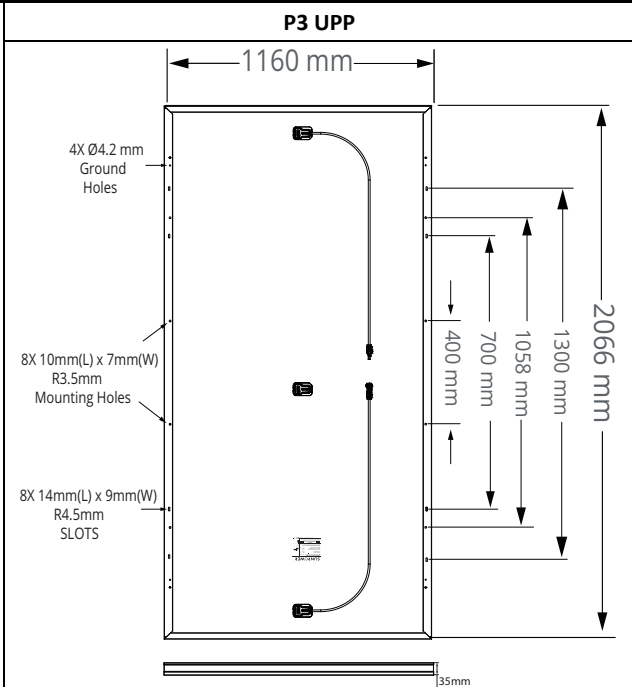
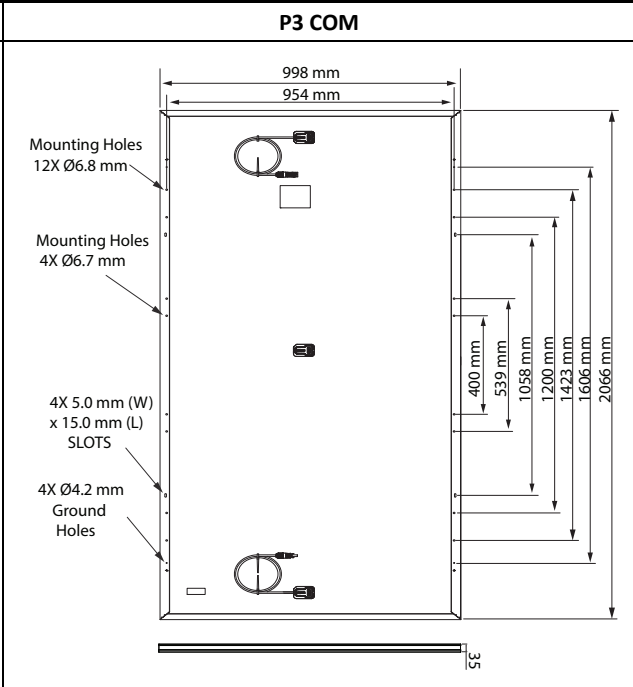
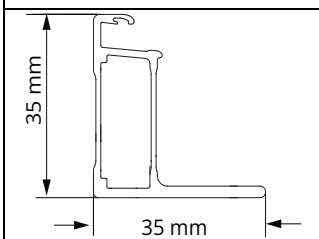
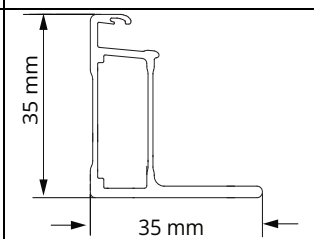
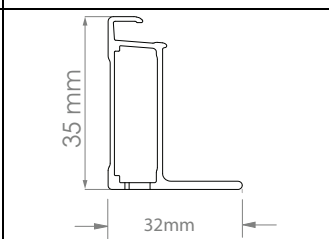
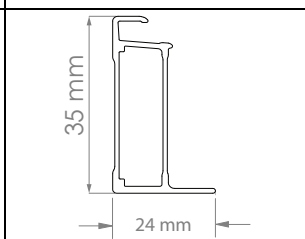
Platform	Module mounting and ground hole detail			
FOR P3 MODULES				
Residential/ Commercial Modules	P3 BLK (GEN 4.3) 		P3 COM (GEN 4.2) 	
	SIDE FRAME PROFILE	END FRAME PROFILE	SIDE FRAME PROFILE	END FRAME PROFILE
				
	FOR P3 GEN 4.3 FRAME MODULES			
Commercial Modules	P3 UPP 		P3 COM 	
	SIDE FRAME PROFILE	END FRAME PROFILE	SIDE FRAME PROFILE	END FRAME PROFILE
				

Measurement Tolerances are +/-3 mm for the Length and Width of the Module.

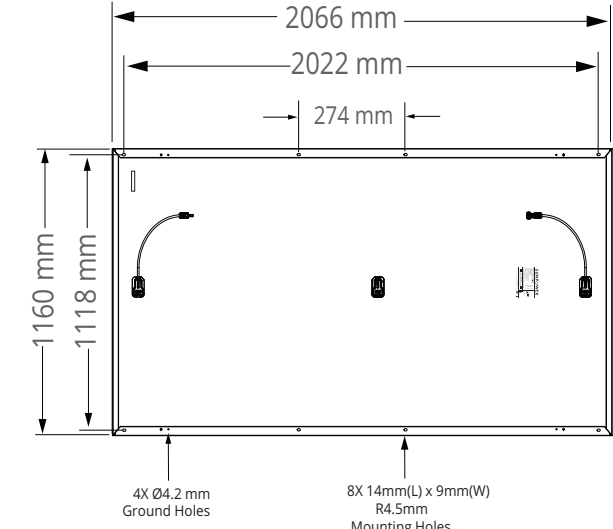
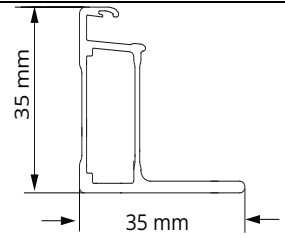
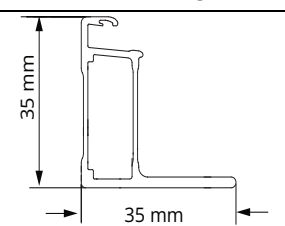
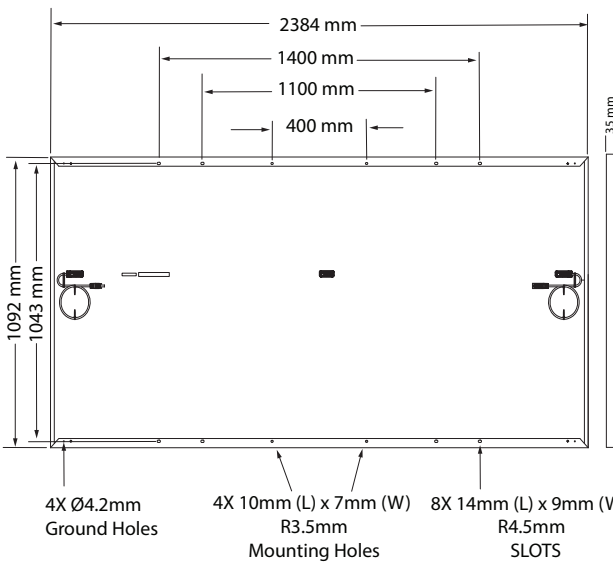
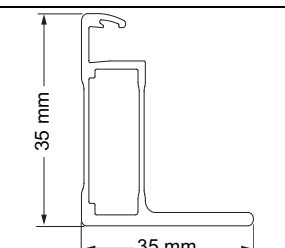
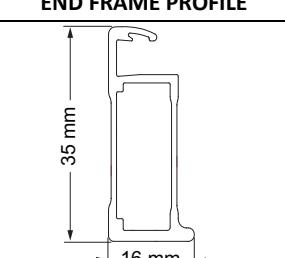
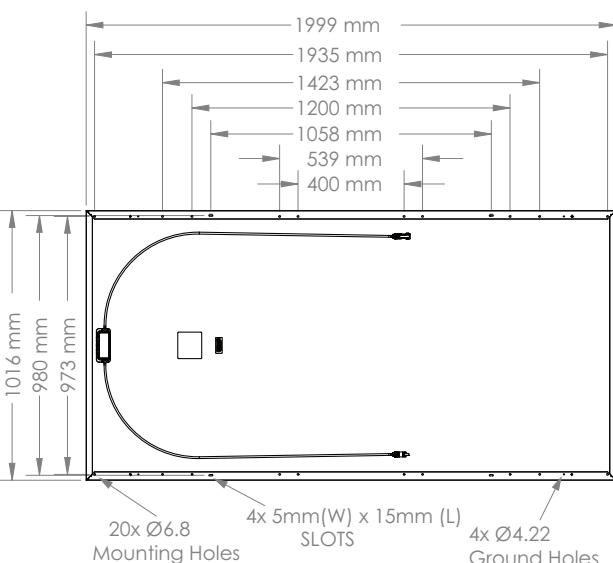
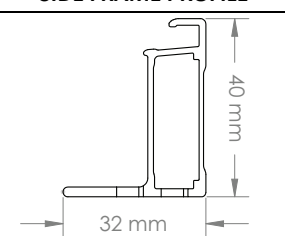
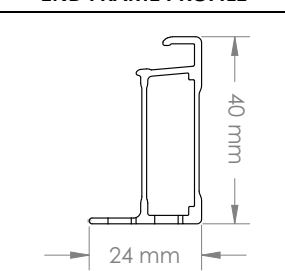
Platform	Module mounting and ground hole detail	Frame Profile
FOR P3 UPP GEN 4.3 (Customized)		
Commercial Modules	 <p style="text-align: center;">4X Ø4.2 mm Ground Holes 8X 14mm(L) x 9mm(W) R4.5mm Mounting Holes</p>	<p style="text-align: center;">SIDE FRAME PROFILE</p>  <p style="text-align: center;">END FRAME PROFILE</p> 
	FOR P5 UPP GEN 4.3	
	 <p style="text-align: center;">4X Ø4.2 mm Ground Holes 4X 10mm (L) x 7mm (W) R3.5mm Mounting Holes 8X 14mm (L) x 9mm (W) R4.5mm SLOTS</p>	<p style="text-align: center;">SIDE FRAME PROFILE</p>  <p style="text-align: center;">END FRAME PROFILE</p> 
	FOR MAX5 GEN 4.2 MODULES	
Commercial Modules	 <p style="text-align: center;">20x Ø6.8 Mounting Holes 4x 5mm(W) x 15mm (L) SLOTS 4x Ø4.22 Ground Holes</p>	<p style="text-align: center;">SIDE FRAME PROFILE</p>  <p style="text-align: center;">END FRAME PROFILE</p> 

Measurement Tolerances are +/-3 mm for the Length and Width of the Module.

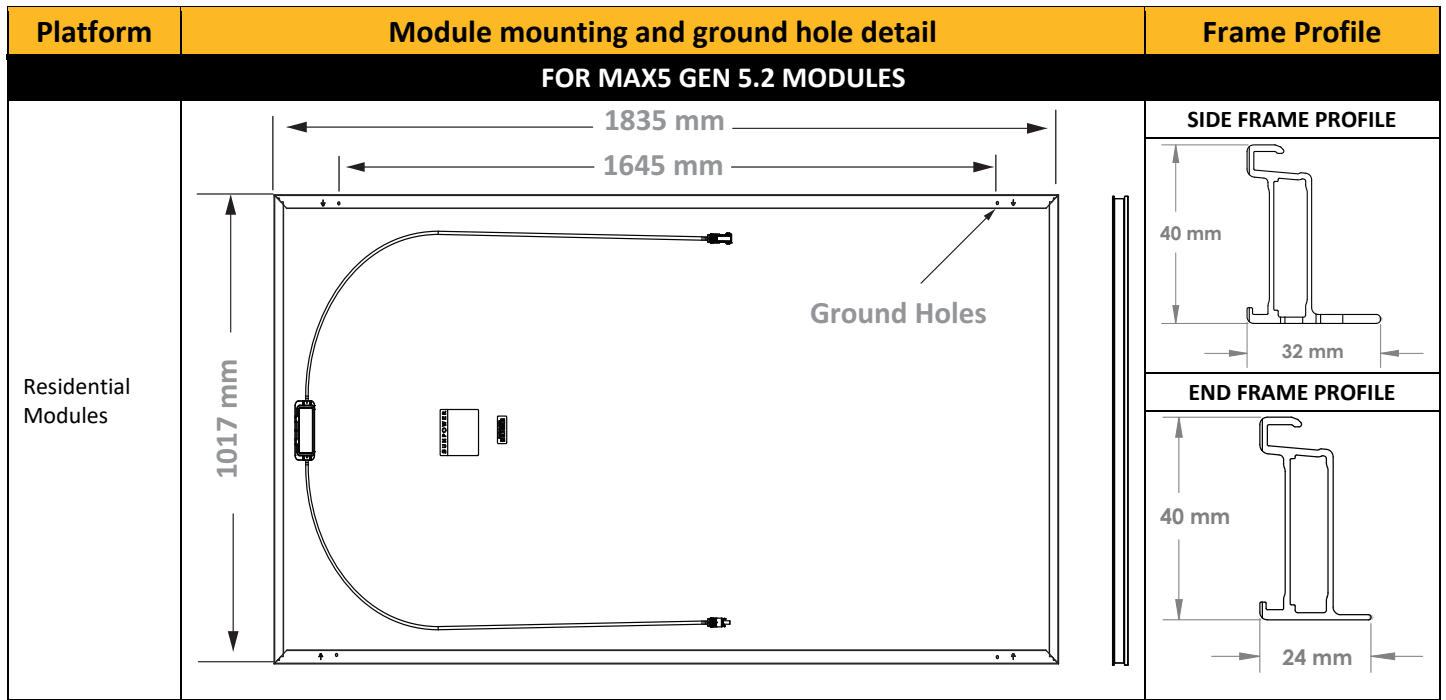

Measurement Tolerances are +/-3 mm for the Length and Width of the Module.