



# Installation Manual of Standard Solar Modules

**Hengdian Group DMEGC Magnetics Co., Ltd.**

Hengdian Industrial Area, Dongyang City, Zhejiang Province China

Tel: +86-579-86310330

E-mail: [service@dmegc.com.cn](mailto:service@dmegc.com.cn)

Ver: 202301

# Contents

1. General Information	3
1.1 Installation Manual Disclaimer	3
1.2 Limitation of Liability	3
2. Safety Precautions	3
3. Mechanical / Electrical Specifications	3
4. Unpacking and Storage	4
5. Module Installation	5
5.1 Module Wiring	6
5.2 Grounding	8
6. Mounting Instructions	8
6.1 Mounting Method: Bolting	9
6.2 Mounting Method: Clamping	9
6.3 Test Loads and Design Loads	10
7. Maintenance	13
8. Module Cleaning Guidelines	14
Annex	15

## 1. General Information

This general manual provides important safety information relating to the installation, maintenance and handling of standard solar modules of DMEGC Solar.

Professional installer must read these guidelines carefully and strictly follow these instructions. Failure to follow these instructions may result in death, injury or property damage. The installation and handling of PV modules require professional skills and should only be performed by qualified professionals. The installers must inform end-users (consumers) the aforesaid information accordingly. The word "module" or "PV module" used in this manual refers to one or more standard solar modules of DMEGC Solar.

This manual is only valid for the standard module types. Refer to the product models in the annex.

Please retain this manual for future reference. We recommend checking [www.dmegcsolar.com](http://www.dmegcsolar.com) regularly for the most updated version.

### 1.1 Installation Manual Disclaimer

The information contained in this manual is subject to change by DMEGC Solar without prior notice. DMEGC Solar gives no warranty of any kind whatsoever, either explicitly or implicitly, with respect to the information contained herein.

In the event of any inconsistency among different language versions of this document, the English version shall prevail. Please refer to our product lists and documents published on our website at: [www.dmegcsolar.com](http://www.dmegcsolar.com) as these lists are updated on a regular basis.

### 1.2 Limitation of Liability

DMEGC Solar shall not be held responsible for damages of any kind, including – without limitation – bodily harm, injury or damage to property, in connection with handling PV modules, system installation, or non-compliance with the instructions set forth in this manual.

## 2. Safety Precautions



### Warning

Before attempting to install, wire, operate and/or service the module and other electrical equipment, all instructions should be read and understood. PV module connectors pass direct current (DC) when exposed to sunlight or other light sources. Contact with electrically active parts of the module, such as terminals, can result in injury or death, irrespective of whether or not the module and the other electrical equipment have been connected.

## General Safety

- All modules must be installed by licensed electricians in accordance to the applicable electrical codes such as, the latest National Electrical Code or other national or international applicable electrical codes.
- Protective clothing (non-slip gloves, clothes, etc.) must be worn during installation to prevent direct contact with 30 V DC or greater, and to protect hands from sharp edges.
- Prior to installation, remove all metallic jewelry to prevent accidental exposure to live circuits.
- When installing modules in light rain, morning dew, take appropriate measures to prevent water ingress into the connector.
- Do not allow children or unauthorized persons near the installation site or module storage area.
- Do not install modules in strong wind.
- Use electrically insulated tools to reduce the risk of electric shock.
- If the disconnects and over current protection devices cannot be opened or the inverter cannot be powered down, cover the fronts of the modules in the PV array with an opaque material to stop the production of electricity when installing or working on a module or wiring.
- Do not use or install damaged modules.
- Contact with module surfaces or frames may cause electric shock if the front glass is broken or the backsheet is torn.
- The PV module does not contain any serviceable parts. Do not attempt to repair any part of the module.
- Keep the junction box cover closed at all times.
- Do not disassemble a module or remove any module part.
- Do not artificially concentrate sunlight on a module.
- Do not connect or disconnect modules when current from the modules or an external source is present.

## 3. Mechanical / Electrical Specifications

Module electrical ratings are measured under Standard Test Conditions (STC) of 1000 W/m<sup>2</sup> irradiance, with an AM1.5 spectrum, and a cell temperature of 25°C. Detailed electrical and mechanical characteristics of DMEGC Solar crystalline silicon PV modules can be found in module datasheets on [www.dmegcsolar.com](http://www.dmegcsolar.com). Main electrical characteristics at STC are also stated on each module label. Please refer to the datasheet or the product nameplate for the maximum system

voltage.

Under certain conditions, a module may produce more current or voltage than its Standard Test Conditions rated power. As a result, the module short-circuit current under STC should be multiplied by 1.25, and a correction factor should be applied to the open-circuit voltage (*see Table 1 below*), when determining component ratings and capacities. Depending on your local regulations, an additional 1.25 multiplier for the short-circuit current (giving a total multiplier of 1.56) may be applicable when sizing conductors and fuses.

*Table 1: Low temperature correction factors for open-circuit voltage*

Lowest Expected Ambient Temperature (°C/°F)	Correction Factor
24 to 20 / 76 to 68	1.02
19 to 15 / 67 to 59	1.04
14 to 10 / 58 to 50	1.06
9 to 5 / 49 to 41	1.08
4 to 0 / 40 to 32	1.10
-1 to -5 / 31 to 23	1.12
-6 to -10 / 22 to 14	1.14
-11 to -15 / 13 to 5	1.16
-16 to -20 / 4 to -4	1.18
-21 to -25 / -5 to -13	1.20
-26 to -30 / -14 to -22	1.21
-31 to -35 / -23 to -31	1.23
-36 to -40 / -32 to -40	1.25

Alternatively, a more accurate correction factor for the open-circuit voltage can be calculated using the following formula:

$$C_{V_{OC}} = 1 - \alpha_{V_{OC}} \times (25 - T)$$

T (°C) is the lowest expected ambient temperature at the system installation site.

$\alpha_{V_{OC}}$  (%/°C) is the voltage temperature coefficient of the selected module (refer to corresponding datasheet).

Electrical calculations and design must be performed by a competent engineer or consultant.

Please contact DMEGC Solar’s technical support team for additional information pertaining to engineering optimization and approval of project specific module string lengths.

#### 4. Unpacking and Storage

**NOTICE** Precautions

- Modules should be stored in a dry and ventilated environment to avoid direct sunlight and moisture. If modules are stored in an uncontrolled environment, the storage time should be less than 3 months and extra precautions should be taken to prevent connectors from

being exposed to moisture or sunlight, like using connector endcaps. In any circumstance, for pallets of modules packaged in landscape orientation, stacking of no more than two layers is allowed, for pallets of modules packaged in portrait orientation, stacking is not allowed.

- When unloading modules pallets from flat truck, please use a crane or a forklift to remove the module pallets. When unloading modules pallets from containers, please use a fork lift to remove the module pallets, and the forklift should be close to the ground in order to avoid the top of module pallets touching the top of the cabinet door. Consult your DMEGC Solar’s representative for more detailed unloading instructions.
- Unpack module pallets carefully, following the steps shown on the pallet. Unpack, transport and store the modules with care.
- Modules must always be unpacked and installed by two or three people. Always use both hands when handling modules.
- Do not lift modules by their wires or junction box, lift them by the frame.
- Do not allow the panels to sag or bow under their own weight when being carried.
- Stacks of modules should contain no more than 12 modules, and the frames should be aligned.
- Do not place excessive loads on the module or twist the module frame.
- Do not stand, step, walk and/or jump on modules under any circumstances. Localized heavy loads may cause severe micro-cracks at cell level, which in turn may compromise module reliability and void DMEGC Solar’s warranty.
- Do not leave the module backsheet directly in contact with the support structure underneath when handling or installing the module.
- Do not carry modules on your head.
- Do not drop or place objects (such as tools) on the modules.
- Do not use sharp instruments on the modules. Particular care should be taken to avoid module backsheets being damaged by sharp objects, as scratches may directly affect product safety.
- Do not leave modules unsupported or unsecured.
- Do not change the wiring of bypass diodes.

- Keep all electrical contacts clean and dry at all times.
- Do not expose the modules and its electrical contacts to any unauthorized chemical substance (e.g. oil, lubricant, pesticide, etc.).

### Product Identification

- Each module has two or three identical barcodes (one in the laminate under the front glass, the second on the rear side of the module and the third on the frame) that act as a unique identifier.
- A nameplate is also affixed to the rear of each module. This nameplate specifies the model type, as well as the main electrical and safety characteristics of the module.

## 5. Module Installation



### Precautionary Measures and General Safety

- Prior to installing modules please obtain information about any requirements and necessary approvals for the site, installation and inspection from the relevant authorities.
- Check applicable building codes to ensure that the construction or structure (roof, facade, support, etc.) can bear the module system load.
- DMEGC Solar's standard modules have been qualified for Application Class A (equivalent to Safety Class II requirements). Modules rated under this class should be used in systems operating at voltage above 50V or power above 240W, where general contact access is anticipated.
- DMEGC Solar's standard modules have been certified as Class C according to IEC 61730-2 for fire class performance, please refer to the datasheet or the product nameplate for the detailed types.
- Consult your local authority for guidelines and requirements for building or structural fire safety. When installing modules, ensure the assembly is mounted over a fire-resistant roof covering rated for the application.
- The fire rating for this module is only valid when the product is installed as specified in the mechanical mounting instructions.

### Environmental Conditions

- PV modules are intended for use in general open-air climates, as defined in IEC 60721-2-1: Classification of environmental conditions Part 2-1: Environmental conditions appearing in nature—Temperature and

humidity.

- It is recommended that PV modules are installed in an environmental temperature range of -40 °C to + 85 °C.
- Please consult the DMEGC Solar's technical support department for more information on the use of modules in special climates, such as an altitude greater than 2000m.
- Do not install modules near open flames or flammable materials.
- Do not immerse modules in water or constantly expose modules to water (either fresh or salt, i.e. from fountains, sea spray).
- Exposing modules to salt (i.e. marine environments) or sulfur (i.e. sulfur sources, volcanoes) incurs the risk of module corrosion.
- Do not expose modules and their connectors to any unauthorized chemical substances (e.g. oil, lubricant, pesticide, etc.), as modules may incur damages

### NOTICE

DMEGC Solar's Modules have passed the IEC61701 salt-mist, but galvanic corrosion can occur between the aluminum frame of the Modules and mounting or grounding hardware if such hardware is comprised of dissimilar metals. DMEGC Solar recommends that when the module is installed in salt-damaged areas such as the sea, the module should be installed at a distance of more than 500m from the coastline. The offshore installation needs to be confirmed with DMEGC Solar and installed after approval.

### Installation Requirements

- Ensure that the module meets the general technical system requirements.
- Ensure that other systems components do not damage the module mechanically or electrically.
- Modules can be wired in series to increase voltage or in parallel to increase current. To connect modules in series, connect the cables from the positive terminal of one module to the negative terminal of the next module. To connect in parallel, connect the cables from the positive terminal of one module to the positive terminal on the next module.
- The quantity of bypass diodes in the module's junction box provided may vary depending on the model series.
- Only connect the quantity of modules that corresponds to

the voltage specifications of the inverters used in the system. In addition, modules must not be connected together to create a voltage higher than the maximum permitted system voltage stated on the module nameplate, even under the worst local temperature conditions (see Table 1 for the correction coefficients that apply to open-circuit voltage).

- A maximum of two strings can be connected in parallel without using an over-current protection device (fuses, etc.) incorporated in series within each string. Three or more strings can be connected in parallel if an appropriate and certified over-current protection device is installed in series within each string. And it shall be ensured in the PV system design that the reverse current of any particular string is lower than the module maximum fuse rating at any circumstances.
- Only modules with similar electrical parameters should be connected in the same string to avoid or minimize mismatch effects in arrays.
- To minimize risk in the event of an indirect lightning strike, avoid forming loops with the wiring when designing the system.
- The recommended maximum series fuse rating is stated in the module datasheets.
- Modules should be safely fixed to bear all expected loads, including wind and snow loads.
- A minimum clearance of 6.5 mm (0.25 in) between modules is required to allow for thermal expansion of the frames.
- The small drainage holes on the underside of the module must not be blocked.

#### **Optimum Orientation and Tilt**

- To maximize the annual yield, please calculate the optimum orientation and tilt for PV modules in that specific installation site. The highest yields are achieved when sunlight shines perpendicularly onto the PV modules.

#### **Avoid Shading**

- Modules shall not be permanently shaded (including partial shading, spot shading, even shading or uneven shading) under any circumstance. Permanent shading includes shading of the same cell, cell row, or module portion for extended and repeated periods of time (e.g. more than 200 daylight hours over the warrantied service

lifetime). Power dissipated in fully or partially shaded cells will result in power loss, reduced yield and can cause localized overheating, which in turn may negatively impact the module service lifetime. Permanent shading may cause accelerated ageing of the encapsulation material and place thermal stress on the bypass diodes. This would void the module's warranty unless properly mitigated through the use of Module Level Power Electronic (MLPE) devices.

- Regular maintenance is required to keep modules clean. Particular measures should be taken to avoid permanent shading from dirt or debris (e.g., plants, bird droppings, etc).
- Do not install modules directly behind any object (e.g., tree, antenna, etc) to prevent occurrence of permanent shading.
- Even temporary partial shading will reduce the energy yield. A module can be considered to be unshaded if its entire surface is free from shading all year round, including on the shortest day of the year.

#### **Reliable Ventilation**

- Sufficient clearance (at least 100 mm (3.94 in)) between the module frame and the mounting surface is required to allow cooling air to circulate around the back of the module. This also allows condensation or moisture to dissipate.
- According to IEC 61730, any other specific clearance required for maintaining a system fire rating should prevail. Detailed clearance requirements pertaining to system fire ratings must be provided by your racking supplier.

#### **5.1 Module Wiring**

##### **Correct Wiring Scheme**

- Cable management scheme should be reviewed and approved by the EPC contractor; in particular required cable lengths should be cross-checked considering the specificities of the tracker structure like bearing house gaps. If longer cable or additional jumper cables are requested, please contact DMEGC Solar's sales representative in advance.
- Ensure that the wiring is correct before starting up the system. If the measured open circuit voltage ( $V_{oc}$ ) and short-circuit current ( $I_{sc}$ ) differ from the specifications, this indicates that there is a wiring fault.

- When modules have been installed but the system has not been connected to the grid yet, each module string should be kept under open-circuit conditions and proper actions should be taken to avoid dust and moisture penetration inside the connectors.
- In case where a cable connection method not included in the below is used, please confirm the suitable cable length with DMEGC Solar's sales representative.
- For different DMEGC Solar's module types, DMEGC Solar offers optional cable lengths to match various system configurations.
- Recommended system cable schemes are shown below:

*1. Portrait two rows installation*

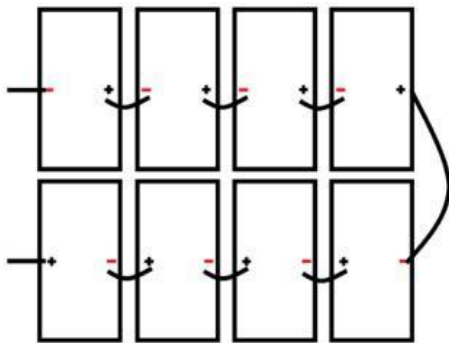

Note: Adjacent two modules (up and down) need to be rotated 180 degrees

*2. Portrait one row installation*

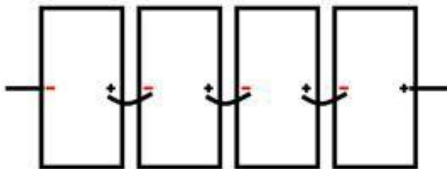

*3. Landscape installation*

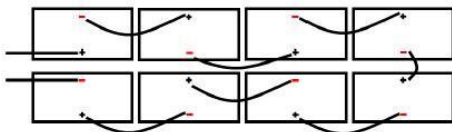

Note: Adjacent two modules (left to right) need to be rotated 180 degrees

*4. Leapfrog*

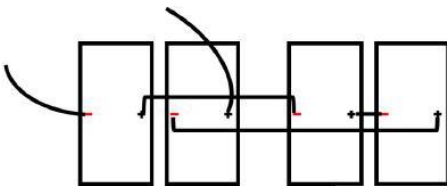

The maximum distance between two adjacent module frames should be within 50 mm (1.96in) for the side with mounting clamps, and 25 mm (0.98in) for the side without mounting clamps, in order to meet the system cable scheme.

**Correct Connection Connectors**

- Make sure that all connections are safe and properly mated. The PV connector should not be subject to stress from the exterior. Connectors should only be used to connect the circuit. They should never be used to turn the circuit on and off.
- Connectors are not waterproof when unmated. When installing modules, connector should be connected to each other as soon as possible or appropriate measures (like using connector endcaps) should be taken to avoid moisture and dust penetrating into the connector.
- Do not connect different connectors (manufacturer and type) together.
- Do not clean or precondition the connectors using lubricants or any unauthorized chemical substances

**Use of Suitable Materials**

- Only use dedicated solar cable and suitable connectors (wiring should be sheathed in a sunlight-resistant conduit or, if exposed, should itself be sunlight-resistant) that meet local fire, building and electrical regulations. Please ensure that all wiring is in perfect electrical and mechanical condition.
- Installers may only use cables listed and labeled as or PV wire, and the cable with a cross section area of at least 4 mm<sup>2</sup> (12 AWG), 90°C wet rated in other areas (i.e. IEC 62930 approved), with proper insulation which is able to withstand the maximum possible system open-circuit voltage.
- Only copper conductor material should be used. Select a suitable conductor gauge to minimize voltage drop and ensure that the conductor ampacity complies with local regulations.

**Cable and Connector Protection**

- Secure the cables to the mounting system using UV-resistant cable ties. Protect exposed cables from damage by taking appropriate precautions (e.g. placing them inside a metallic raceway like EMT conduit). Avoid exposure to direct sunlight.
- A minimum bending radius of 60 mm (2.36 in) is required when securing the junction box cables to the racking system.
- Protect exposed connectors from weathering damage by taking appropriate precautions. Avoid exposure to direct sunlight.

- Do not place connectors in locations where water could easily accumulate.

**5.2 Grounding**

- Although the modules are certified to Safety Class II, we recommend them to be grounded and that module installation should comply with all applicable local electrical codes and regulations. Minimum size of equipment grounding conductors for ground raceway and equipment should be considered. Grounding connections should be installed by a qualified electrician. Connect module frames together using adequate grounding cables: the use of 4-14 mm<sup>2</sup> (AWG 6-12) copper wire is recommended. Holes provided for this purpose are identified with a grounding symbol  $\perp$  (IEC 61730-1). All conductive connection junctions must be firmly fixed.
- Do not drill any extra ground holes for convenience as this will void the modules warranty.
- All bolts, nuts, flat washers, lock washers and other relevant hardware should be made of stainless steel, unless otherwise specified.
- DMEGC Solar does not provide grounding hardware.
- The grounding method described below is commended by DMEGC Solar.

**Grounding by grounding bolt**

- Use M8 bolt and washers to bond the ground wire and aluminum frame through the grounding holes (as shown *figure 1*). The tightening torque is 3-7N.m. All nuts and washers should be made of stainless steel.

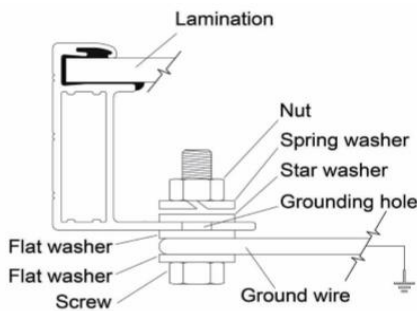

*figure 1*

**Grounding by using grounding clamp**

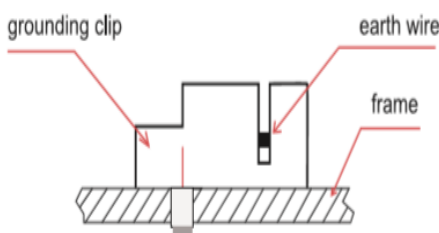

*figure 2*

- As shown in the *figure2*, the grounding clip assembly consists of a slider, base, and self-captivating thread-cutting screw or 8-32 screw and hex nut. The grounding clip accepts solid uninsulated copper wire sizes 10 or 12 AWG.

**Addition Third-party Grounding Devices**

- DMEGC Solar's Modules can be grounded using third party grounding devices so long as they are certified for grounding modules and the devices are installed according to the manufacturer's specified instructions.

**6. Mounting Instructions**

The applicable regulations pertaining to work safety, accident prevention and securing the construction site must be observed. Workers and third party personnel shall wear or install fall arrest equipment. Any third party need to be protected against injuries and damages.

- The mounting design must be certified by a registered professional engineer. The mounting design and procedures must comply with all applicable local codes and requirements from all relevant authorities.
- The module is considered to be in compliance with IEC 61730 and IEC 61215 only when the module is mounted in the manner specified by the mounting instructions included in this installation manual.
- The system designer and installer are responsible for load calculations and for proper design of support structure.
- Any module without a frame (laminate) shall not be considered to comply with the requirements of IEC 61730 unless the module is mounted with hardware that has been tested and evaluated with the module under this standard or by a field Inspection certifying that the installed module complies with the requirements of IEC 61730.
- DMEGC Solar does not provide mounting hardware.
- Standard modules can be mounted onto a support structure using one of several approved methods as described below. For information about other installation methods, please contact your local representative. Failure to use a recognized installation method will void the DMEGC Solar's warranty.
- Use appropriate corrosion-proof fastening materials. All mounting hardware (bolts, spring washers, flat washers, nuts) should be hot dip galvanized or stainless steel.



- Use a torque wrench for installation.
- Do not drill additional holes or modify the module frame. Doing so will void the warranty.
- Standard modules can be installed in either landscape or portrait orientations. Refer to the detailed instructions for further guidance. Please note that in areas with heavy snowfall (> 2400 Pa) further countermeasures such the use of additional support bars should be considered to avoid snow loads damaging the lowest row of modules.
- The loads described in this manual correspond to test loads. For installations complying with IEC 61215 and IEC 61730, a safety factor of 1.5 should be applied for calculating the equivalent maximum authorized design loads. Project design loads depend on construction, applicable standards, location and local climate. Determination of the design loads is the responsibility of the racking suppliers and/or professional engineers. For detailed information, please follow local structural code or contact your professional structural engineer.

**6.1 Mounting Method: Bolting**

- The mechanical load test with these mounting methods were performed according to IEC 61215.
- Modules should be bolted to supporting structures through the mounting holes in the rear frame flanges only.
- In areas with heavy wind loads, additional mounting points should be used. The system designer and the installer are responsible for correctly calculating the loads and ensuring that the supporting structure meets all the applicable requirements.
- Each module must be securely fastened at a minimum of 4 points on two opposite sides.
- Tightening torques should be 15~20 N•m for M8 coarse thread bolts, depending on bolt class.
- The method and the specifications of the fixing parts are shown in the *figure 3* below:

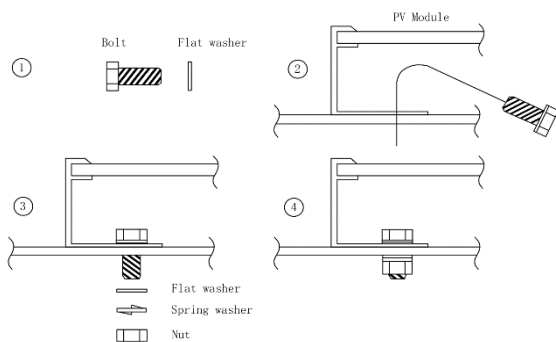

*figure 3*

Bolt	Flat Washer
Material: stainless steel size: M8*20mm	Material: stainless steel size: M8 thickness: ≥1.6mm
Spring Washer	Nut
Material: stainless steel size: M8 thickness: ≥2.0mm	Material: stainless steel size: M8

**6.2 Mounting Method: Clamping**

- The mechanical load test with these mounting methods were performed according to IEC 61215.
- Top or bottom clamping methods will vary and are dependent on the mounting structures. Please follow the mounting guidelines recommended by the mounting system supplier.
- Each module must be securely fastened at a minimum of four points on two opposite sides. The clamps should be positioned symmetrically. The clamps should be positioned according to the authorized position ranges.
- Install and tighten the module clamps to the mounting rails using the torque stated by the mounting hardware manufacturer. M8 bolt and nut are used for this clamping method.
- Tightening torques should be within 18~24 N•m for M8 coarse thread bolts, depending on the bolt class. For the bolt grade, the technical guideline from the fastener suppliers should be followed. Different recommendations from specific clamping hardware suppliers should prevail.
- The system designer and installer are responsible for load calculations and for proper design of support structure.
- DMEGC Solar’s warranty may be void in cases where improper clamps or unsuitable installation methods are found. When installing inter-modules or end-type clamps, please take the following measures into account:
  1. Do not bend the module frame.
  2. Do not touch or cast shadows on the front glass.
  3. Do not damage the surface of the frame (to the exception of the clamps with bonding pins).
  4. Ensure the clamps overlap the module frame by at least 7mm but no more than 12mm.
  5. Overlap in length by at least 50mm.
  6. Ensure the clamp thickness is at least 3 mm.
- Clamp material should be anodized aluminum alloy or stainless steel. The mounting details are shown in the following *figures4* and *figures5*.

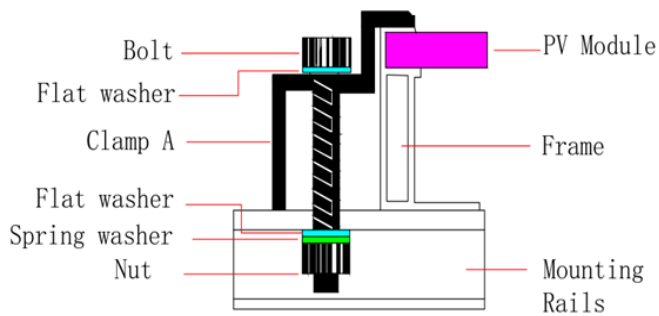

figure4

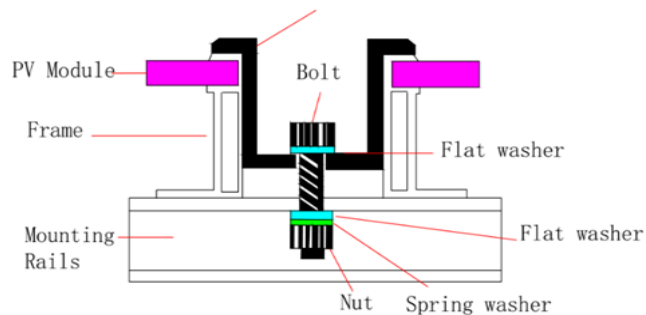

figure 5

### 6.3 Test Loads and Design Loads

- The Standard/lower loading capacity applies to normal environment: the modules are tested under a maximum positive pressure of 2400 Pa, and negative pressure of 1600 Pa, the modules are designed to meet a maximum positive pressure of 1600Pa, and negative pressure of 1067 Pa, this design load was then tested with a safety factor of 1.5 times.
- The high loading capacity applies to severe environment,

like storm, big snow, etc. The modules are tested under a maximum positive pressure of 5400 Pa, and negative pressure of 2400 Pa, the modules are designed to meet a maximum positive pressure of 3600 Pa, and negative pressure of 1600 Pa, this design load was then tested with a safety factor of 1.5 times.



- For bifacial double-glass modules, it is recommended that the beam is installed parallel to the long frame to reduce backside shading.

#### M10-66 / 72 / 78 (Mono-facial & Bifacial-dual glass)

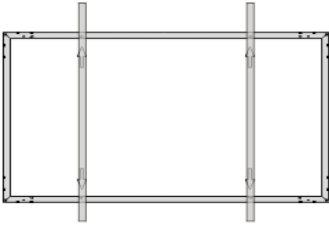
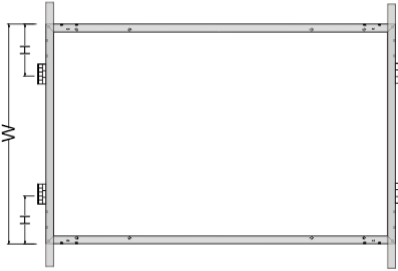
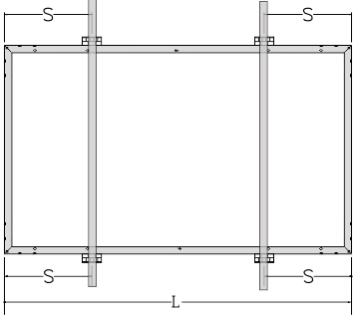
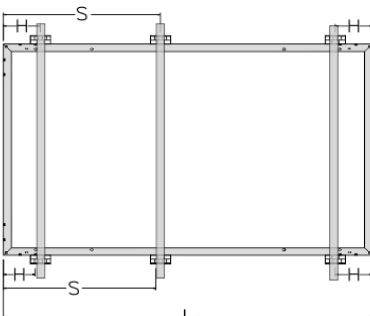
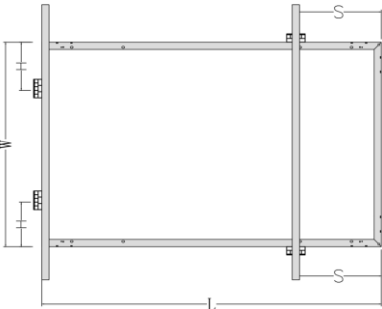

Installation method	4 bolts at the long frame (60H inner holes)	4 bolts at the long frame (66H/72H/78H outer holes)
Bolt installation		
Loading capacity	Test load: positive 3600Pa, negative 2400Pa Design load: positive 2400Pa, negative 1600Pa	Test load: positive 3600Pa, negative 2400Pa Design load: positive 2400Pa, negative 1600Pa
Installation method	4 clamps at the long frame	6 clamps at the long frame
Clamp installation		
Clamp position	$(1/5L-50) < S < (1/5L+50)$	$(1/2L-80) < S < (1/2L-30); (1/6L-50) < H < (1/6L+50)$
Loading capacity	Test load: positive 5400Pa, negative 2400Pa Design load: positive 3600Pa, negative 1600Pa	Test load: positive 5400Pa, negative 3600Pa Design load: positive 3600Pa, negative 2400Pa

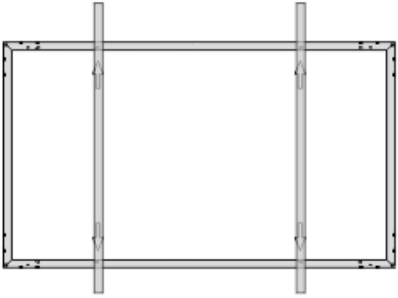
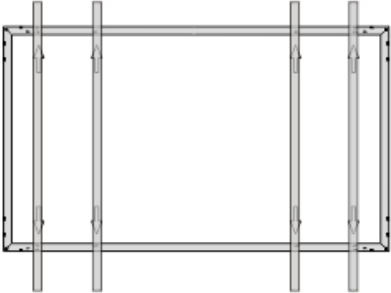
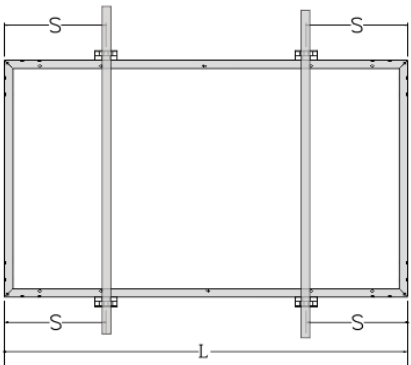
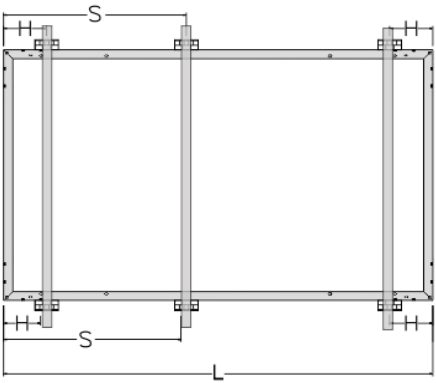
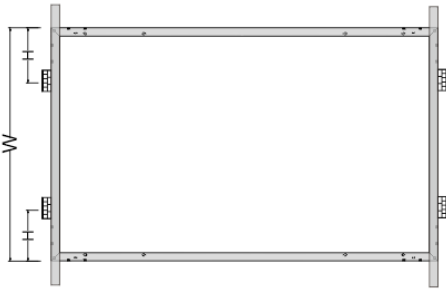
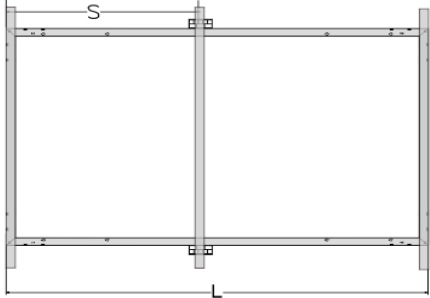
M10-54 (Mono-facial & Bifacial-dual glass)			
Installation method	4 bolts at the long frame	Installation method	4 clamps at the short frame
Bolt installation		Clamp installation	
		Clamp position	$0 < H < 1/4W$
Loading capacity	Test load: positive 5400Pa, negative 2400Pa Design load: positive 3600Pa, negative 1600Pa	Loading capacity	Test load: positive 2400Pa, negative 1600Pa Design load: positive 1600Pa, negative 1067Pa
Installation method	4 clamps at the long frame	6 clamps at the long frame	
Clamp installation			
	Clamp position	$(1/5L-50) < S < (1/5L+50)$	
Loading capacity	Test load: positive 5400Pa, negative 2400Pa Design load: positive 3600Pa, negative 1600Pa	Test load: positive 5400Pa, negative 3600Pa Design load: positive 3600Pa, negative 2400Pa	
Installation method	2 clamps at the short frame 2 clamps at the long frame		
Clamp installation			
	Clamp position	$(1/4L-50) < S < (1/4L+50),$ $(1/4W-50) < H < (1/4W+50)$	
Loading capacity	Test load: positive 2400Pa, negative 2400Pa Design load: positive 1600Pa, negative 1600Pa		

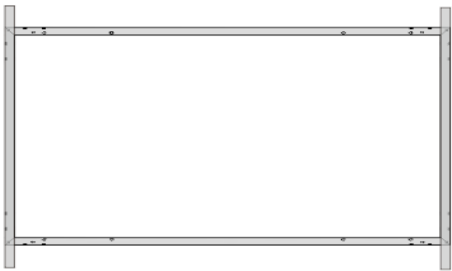
**M2、P1、G1、M6-72/72H (Mono-facial & Bifacial-dual glass)**

Installation method	4 bolts at the long frame (inner holes)	8 bolts at the long frame
Bolt installation		
Loading capacity	Test load: positive 3600Pa, negative 2400Pa Design load: positive 2400Pa, negative 1600Pa	Test load: positive 5400Pa, negative 3600Pa Design load: positive 3600Pa, negative 2400Pa
Installation method	4 clamps at the long frame	6 clamps at the long frame
Clamp installation		
Clamp position	$(1/4L-50) < S < (1/4L+50)$	$(1/2L-80) < S < (1/2L-30)$ ; $(1/6L-50) < H < (1/6L+50)$
Loading capacity	Test load: positive 5400Pa, negative 2400Pa Design load: positive 3600Pa, negative 1600Pa	Test load: positive 5400Pa, negative 3600Pa Design load: positive 3600Pa, negative 2400Pa
Installation method	4 clamps at the short frame	Short side in-rail installation +long side reinforce with clamps
Clamp installation		
Clamp position	$0 < H < 1/4W$	$(1/2L-80) < S < (1/2L-30)$
Loading capacity	Test load: positive 1600Pa, negative 1600Pa Design load: positive 1067Pa, negative 1067Pa	Test load: positive 5400Pa, negative 2400Pa Design load: positive 3600Pa, negative 1600Pa
Installation method	Long side in-rail installation	Short side in-rail installation
In-rail installation		
Loading capacity	Test load: positive 5400Pa, negative 2400Pa Design load: positive 3600Pa, negative 1600Pa	Test load: positive 1600Pa, negative 1600Pa Design load: positive 1067Pa, negative 1067Pa

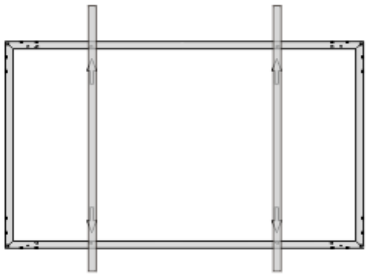
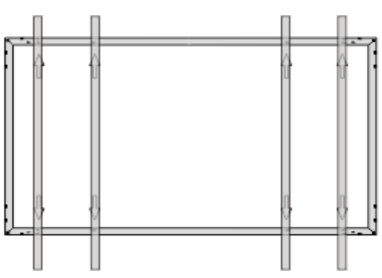
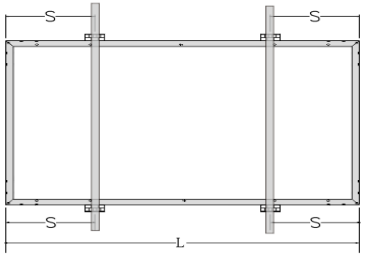
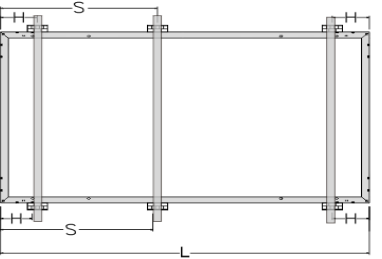
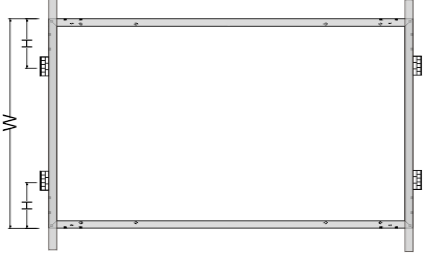
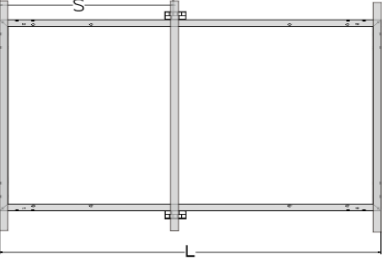
**M2、P1、G1、M6--60/60H (Mono-facial & Bifacial-dual glass)**

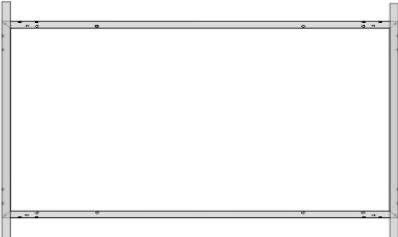
Installation method	4 bolts at the long frame (inner holes)	8 bolts at the long frame
Bolt installation		
Loading capacity	Test load: positive 5400Pa, negative 2400Pa Design load: positive 3600Pa, negative 1600Pa	Test load: positive 5400Pa, negative 3600Pa Design load: positive 3600Pa, negative 2400Pa
Installation method	4 clamps at the long frame	6 clamps at the long frame
Clamp installation		
Clamp position	$(1/4L-50)<S<(1/4L+50)$	$(1/2L-80)<S<(1/2L-30); (1/6L-50)<H<(1/6L+50)$
Loading capacity	Test load: positive 5400Pa, negative 2400Pa Design load: positive 3600Pa, negative 1600Pa	Test load: positive 5400Pa, negative 3600Pa Design load: positive 3600Pa, negative 2400Pa
Installation method	4 clamps at shorter frames	Short side in-rail installation + long side reinforce with clamps
Clamp installation		
Clamp position	$0<H<1/4W$	$(1/2L-80)<S<(1/2L-30)$
Loading capacity	Test load: positive 2400Pa, negative 1600Pa Design load: positive 1600Pa, negative 1067Pa	Test load: positive 5400Pa, negative 2400Pa Design load: positive 3600Pa, negative 1600Pa
Installation method	Long side in-rail installation	Short side in-rail installation
In-rail installation		
Loading capacity	Test load: positive 5400Pa, negative 2400Pa Design load: positive 3600Pa, negative 1600Pa	Test load: positive 2400Pa, negative 1600Pa Design load: positive 1600Pa, negative 1067Pa

**7. Maintenance**

- Do not make modifications to any component of the PV module (diode, junction box, connectors or others).

- Regular maintenance is required to keep modules clear of snow, bird droppings, seeds, pollen, leaves, branches, dirt spots, and dust.
- Modules with sufficient tilt (at least 15°), generally may not

require cleaning (rain will have a self-cleaning effect). If the module has become soiled, wash with water and a non-abrasive cleaning implement (sponge) during the cool part of the day. Do not scrape or rub dry dirt away, as this may cause micro scratches.

**NOTICE**

- Snow should be removed using a soft brush.
- Periodically inspect the system to check the integrity of all wiring and supports.
- To protect against electric shock or injury, electrical or mechanical inspections and maintenance should be performed by qualified personnel only.

**8. Module Cleaning Guidelines**

- This manual covers the requirements for the cleaning procedure of PV modules of DMEGC Solar. The purpose of these cleaning guidelines is to provide general information for cleaning DMEGC Solar's modules. System users and professional installers should read these guidelines carefully and strictly follow these instructions.
- Failure to follow these instructions may result in death, injury or damage to the photovoltaic modules. Damages induced by inappropriate cleaning procedures will void DMEGC Solar's warranty.

**Safety Warning**

- Cleaning activities create risk of damaging the modules and array components, as well as increasing the potential electric shock hazard.
- Cracked or broken modules represent an electric shock hazard due to leakage currents, and the risk of shock is increased when modules are wet. Before cleaning, thoroughly inspect modules for cracks, damage, and loose connections.
- The voltage and current present in an array during daylight hours are sufficient to cause a lethal electrical shock.
- Ensure that the circuit is disconnected before starting the cleaning procedure as contact with leakage of electrically active parts can result in injury.
- Ensure that the array has been disconnected to other active components (such as inverter or combiner boxes) before starting with the cleaning.
- Wear suitable protection (clothes, insulated gloves, etc.).
- Do not immerse the module, partially or totally, in water or any other cleaning solution.

- Rear side cleaning of the modules is not required. If cleaning the rear of a module is desired, care should be taken to ensure there is no damage caused to the backsheet by simply clearing the contaminant by hand or with a soft sponge.

**Handling Notice**

- Use a proper cleaning solution and suitable cleaning equipment.
- Do not use abrasive or electric cleaners on the module.
- Particular attention should be taken to avoid the module backsheet or frame to come in contact with sharp objects, as scratches may directly affect product safety.
- Do not use abrasive cleaners, de-greasers or any unauthorized chemical substance (e.g. oil, lubricant, pesticide, etc.) on the module.
- Do not use cleaning corrosive solutions containing hydrofluoric acid, alkali, acetone, or industrial alcohol. Only substances explicitly approved by DMEGC Solar are allowed to be used for cleaning modules.
- For cleaning methods using rotating brush, please consult with DMEGC Solar's technical support before using.
- Dirt must never be scraped or rubbed away when dry, as this will cause micro-scratches on the glass surface.

**OPERATION PREPARATION**

- Noticeable dirt must be rubbed away by gentle cleaning implement (soft cloth, sponge or brush with soft bristles).
- Ensure that brushes or agitating tools are not abrasive to glass, EPDM, silicone, aluminum, or steel.
- Conduct the cleaning activities avoiding the hottest hours of the day, in order to avoid thermal stress on the module.

**CLEANING METHODS****Method A: Compressed Air**

DMEGC Solar recommends cleaning the soft dirt (like dust) on modules just with air pressure. This technique can be applied as long as the method is efficient enough considering the existing conditions.

**Method B: Wet cleaning**

- If excessive soiling is present on the module surface, a non-conductive brush, sponge, or other mild agitating method may be used with caution.
- Ensure that any brushes or agitating tools are constructed with non-conductive materials to minimize risk of electric shock and that they are not abrasive to the

- glass or the aluminum frame.
- If grease is present, an environmental-friendly cleaning agent may be used with caution.
- DMEGC Solar recommends the following to be used:

1. Water with low mineral content
2. Near neutral pH water
3. The maximum water pressure recommended is 4 MPa (40 bar)

**Annex**

<b>Mono-facial Modules</b>	<b>Bifacial-dual glass Modules</b>
DMXXXM10T-54HSW/HBW/HBB	DMXXXM10T-B54HSW/HBW/HBB/HBT/HST
DMXXXM10T-66HSW/HBW/HBB	DMXXXM10T-B66HSW/HBW/HBB/HBT/HST
DMXXXM10T-72HSW/HBW/HBB	DMXXXM10T-B72HSW/HBW/HBB/HBT/HST
DMXXXM10T-78HSW/HBW	DMXXXM10T-B78HSW/HBW/HBT/HST
DMXXXM10-54HSW/HBW/HBB	DMXXXM10-G/B54HSW/HBW/HBB/HBT/HST
DMXXXM10-66HSW/HBW/HBB	DMXXXM10-G/B66HSW/HBW/HBB/HBT/HST
DMXXXM10-72HSW/HBW/HBB	DMXXXM10-G/B72HSW/HBW/HBB/HBT/HST
DMXXXM10-78HSW/HBW	DMXXXM10-G/B78HSW/HBW/HBB/HBT/HST
DMXXXM6-60HSW/HBW/HBB	DMXXXM6-G/B60HSW//HBW/HBB/HBT/HST
DMXXXM6-72HSW/HBW/HBB	DMXXXM6-G/B72HSW/HBW/HBB/HBT/HST
DMXXXG1-60HSW/HBW/HBB	DMXXXG1-G/B60HSW/HBW/HBB/HBT/HST
DMXXXG1-72HSW/HBW/HBB	DMXXXG1-G/B72HSW/HBW/HBB/HBT/HST
DMXXXG1-60SW/BW/BB	DMXXXG1-G/B60SW/BW/BB/BT/ST
DMXXXG1-72SW/BW/BB	DMXXXG1-G/B72SW/BW/BB/BT/ST
DMXXXM2-60HSW/HBW/HBB	DMXXXM2-G/B60HSW/HBW/HBB/HBT/HST
DMXXXM2-72HSW/HBW/HBB	DMXXXM2-G/B72HSW/HBW/HBB/HBT/HST
DMXXXM2-60SW/BW/BB	DMXXXM2-G/B60SW/BW/BB/BT
DMXXXM2-72SW/BW/BB	DMXXXM2-G/B72SW/BW/BB/BT
DMXXXP1-60HSW/BW	
DMXXXP1-72HSW/BW	
DMXXXP1-60SW/BW	
DMXXXP1-72SW/BW	